

A M · F M · T E L E V I S I O N

# BROADCAST

N E W S

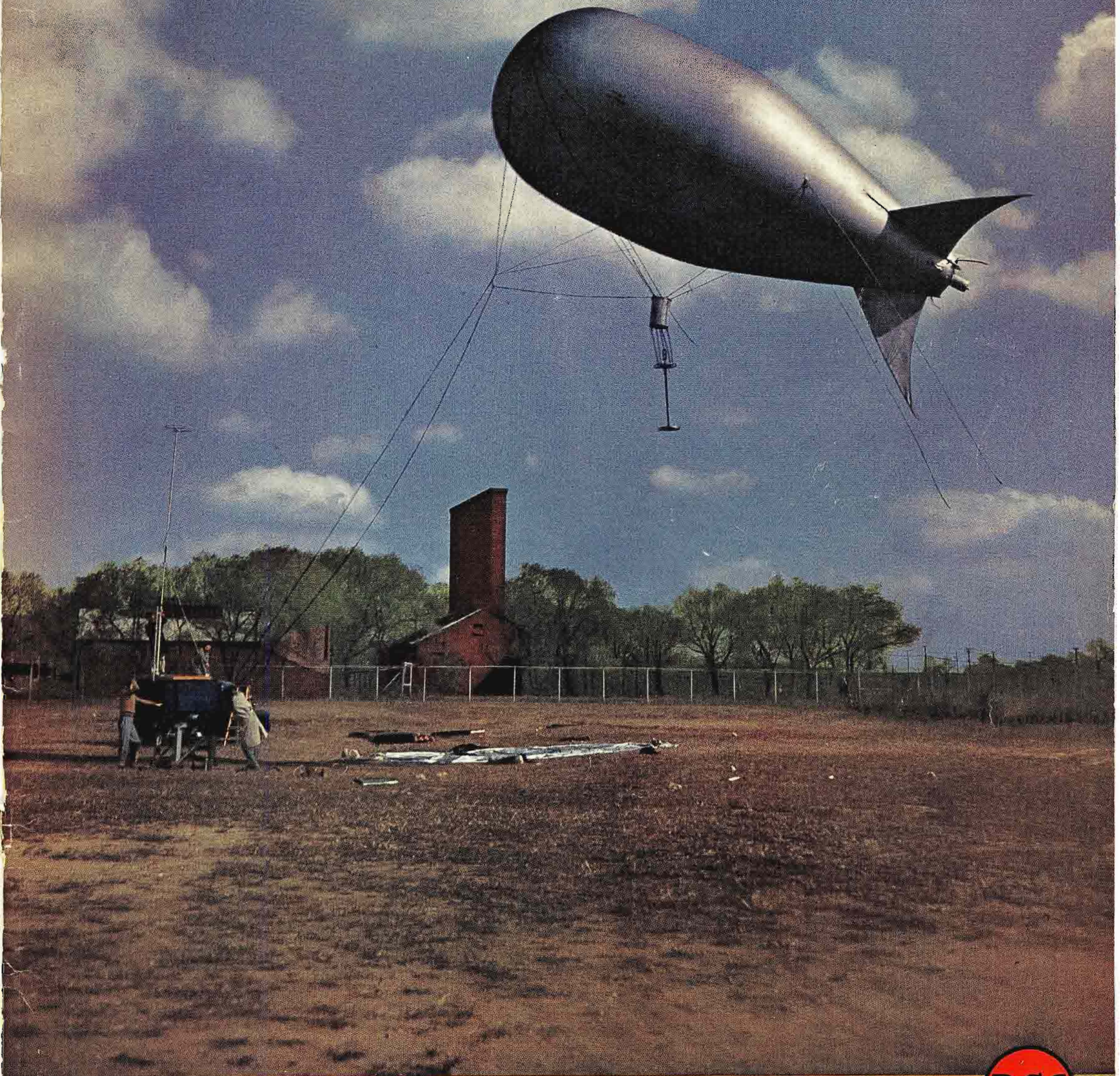

SITE TESTING FOR FM AND TV . . . See pg. 8



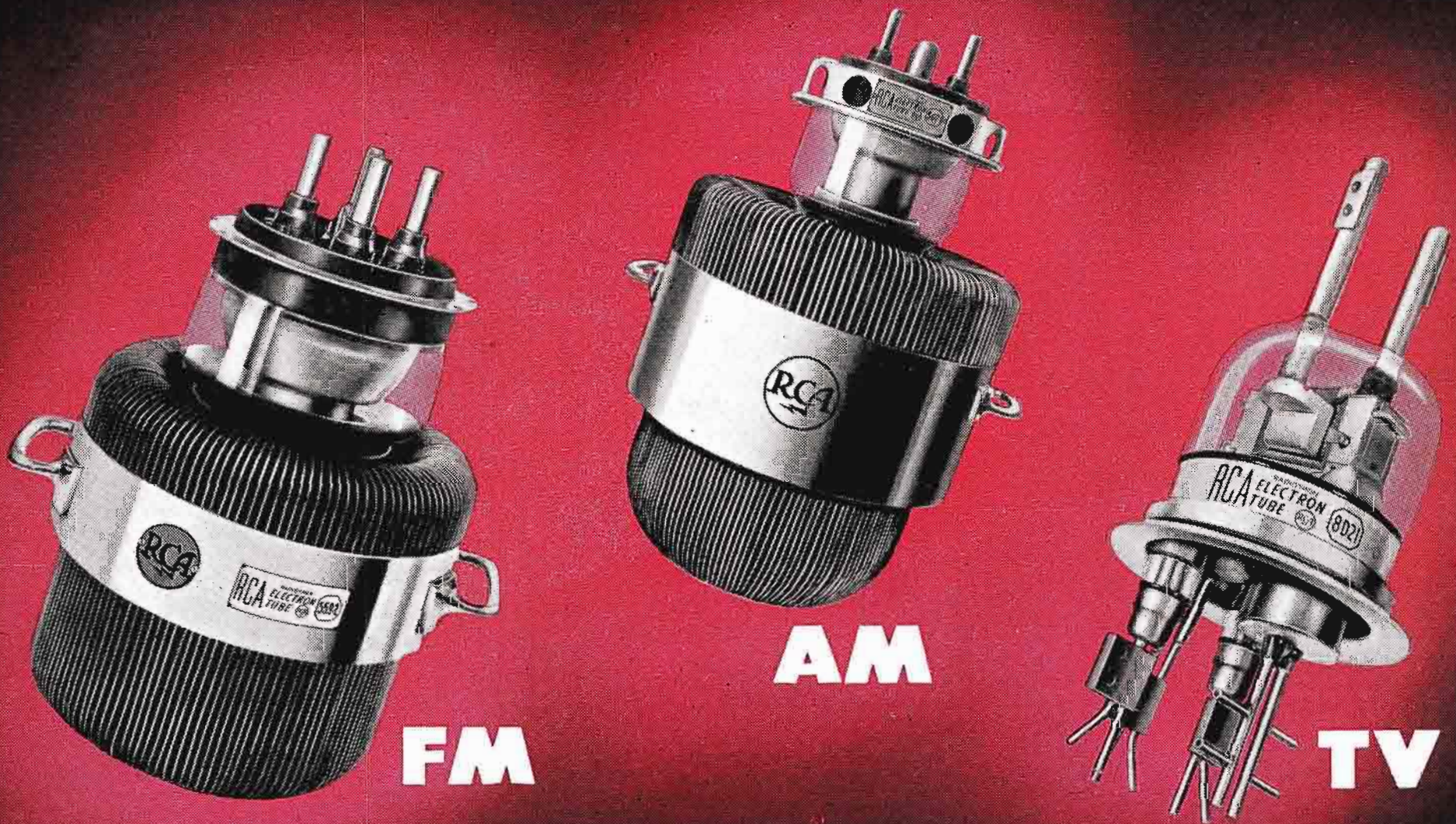

RCA-5592, used in 50-kw  
FM transmitters

RCA-5671, with thoriated filament,  
used in 50-kw AM transmitters

RCA-8D21, used in 5-kw  
television transmitters

## RCA covers the field

RCA has the most complete and up-to-date line of tubes in the broadcast field.

RCA's years of experience in tube research and development have resulted in new and improved types for AM, FM, and TV broadcasting . . . tubes that have advanced the art of broadcasting in all its phases.

Year after year, RCA tubes have set the pace in quality, performance, and value. They have won an unequalled reputation for engineering excellence, dependability, and

true operating economy. That's why experienced broadcasters buy RCA tubes.

For your convenience, RCA tubes are now available from your local RCA Tube Distributor or directly from RCA. For information on any RCA tube, write RCA, Commercial Engineering, Section 37 DP-1, Harrison, N.J.

The world's most modern tube plant...

**RCA, LANCASTER, PA.**

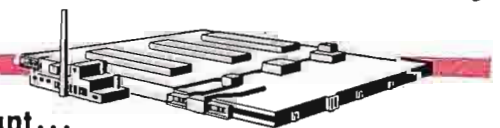

THE FOUNTAINHEAD OF MODERN TUBE DEVELOPMENT IS RCA



**TUBE DEPARTMENT**

**RADIO CORPORATION of AMERICA**

**HARRISON, N. J.**

# Broadcast News

AM • FM • TELEVISION

Published by the

**RADIO CORPORATION OF AMERICA**

ENGINEERING PRODUCTS DEPARTMENT . . . CAMDEN, NEW JERSEY

NUMBER 55

*Subscription Rates*

JUNE, 1949

In continental U. S. A. - \$4.00 for 12 issues  
In other countries - - - \$5.00 for 12 issues

JOHN P. TAYLOR, Editor

JUDY J. ALES, Ass't Editor

W. O. HADLOCK, M. L. GASKILL, E. B. MAY, Associate Editors

## Contents

<b>OPTIMUM HIGH-FREQUENCY BIAS IN MAGNETIC RECORDING</b>	
<i>by G. L. DIMMICK AND S. W. JOHNSON</i>	4
<b>TV AND FM SITE TESTING . . . . .</b>	
<i>by E. S. CLAMMER AND E. M. BROWN</i>	8
<b>RCA DISPLAYS COMPLETE LINE OF EQUIPMENT AT NAB CONVENTION . . . . .</b>	16
<b>CROSSOVER FILTER FOR DISK RECORDING HEADS . . . . .</b>	
<i>by H. E. ROYS</i>	20
<b>BROADCASTERS COMPLETE 7TH RCA TV CLINIC . . . . .</b>	24
<b>NEW CUSTOM MOBILE UNIT . . . . .</b>	
<i>by E. L. SCHACHT</i>	28
<b>WMGM CUSTOM EQUIPMENT . . . . .</b>	
<i>by M. E. GUNN</i>	30
<b>TV BLUEPRINT . . . . .</b>	
<i>by ROBERT C. DEIGERT AND DAVID N. YERKES</i>	38
<b>A NEW 150 KW AM TRANSMITTER . . . . .</b>	
<i>by T. J. BOERNER</i>	42
<b>WRAK-FM, WILLIAMSPORT, PA. . . . .</b>	50
<b>OSCILLOSCOPES AND VACUUM TUBE VOLTMETERS</b>	
<i>by GEORGE E. REILING AND PAUL A. GREENMEYER</i>	52
<b>THE PHILOSOPHY OF OUR TV SYSTEM (PART III) . . . . .</b>	
<i>by JOHN H. ROE</i>	63

Copyright  
Radio Corporation of America  
RCA Victor Division  
Camden, N. J.

PRINTED  
IN  
U.S.A.

**OUR COVER** for this issue shows the barrage balloon used for site-testing (see story, Page 8) at a critical stage in its daily ascension (said stage being that of getting it above the fence, where two balloons came to an untimely and most undignified end). Picture is reproduced from a Kodachrome made by Jim Gaynor, manager of our photographic section.

**SITE TESTING** is a hot subject that may become hotter (as more TV stations go on the air and the choice locations are gradually pre-empted). The methods described in the article by Clammer and Brown (Page 8) are not considered to be the final answer. However, as experiments they are interesting—and for some special cases they may well represent a logical approach to the determination of a satisfactory site. That a comprehensive survey made in this manner would be expensive, is obvious. But the cost would be small compared to that of making a mistake which might, at a later date, require moving the whole transmitter plant.

**IMPORTANCE OF ENGINEERING** in TV operations is well illustrated by the problem of site selection. The selection of a studio site, the design of the studio building, the decision on number and size of studios and the choice of the equipment itself, all pose questions to which a wrong answer is going to cost someone a lot of jack. In fact, the complexity of TV is such that the cost of amortizing original equipment and installation expenditures, plus the normal replacement, maintenance, and operating costs will add up to a far larger part of the overall station costs than is the case in AM and FM. Thus, good engineering—which will keep these costs at a minimum while providing necessary flexibility of facilities—is far more important in TV. So much so that a TV station cannot afford to have less than the best engineers it can hire. Their salaries will be a small part of the money they save!

**ENGINEERS ARE VIP's**, is not a new subject with us—it's been our theme song for a long while. And, more and more often these days we see some real recognition of the fact. Latest is announcement that Jack Leitch, long time technical director of WCAU (AM, FM, Fax and TV), has been elected a Vice President of WCAU, Inc. He thus joins a growing circle of engineering VP's, which now includes Morrie Pierce at WGAR, R. J. Rockwell at WLW, Jack Poppele at WOR, Paul Loyal at WHO, Jack Dewitt at WSM (the latter two now station managers) and a considerable number of others—not to speak of the network technical directors: Bill Lodge at CBS, Frank Marx at ABC, E. M. Johnson at MBS and O. B. Hanson at NBC, all of whom are Vice Presidents of their respective companies.

**NAB POSTSCRIPTS**, we think, should give a little more credit where a lot more is due. We've seen numerous accounts of the engineering and management conferences—and they vary considerably. All of them agree, however, on one point—namely that the whole Convention was handled with remarkable efficiency and with a surprising and infinitely pleasing lack of red tape.

Unfortunately, many of these accounts stop there—instead of going on to point out that this efficiency and the lack of red tape were almost 100% due to the determined efforts of a small band of NAB staffers. This group was headed by Mr. C. E. Arney, NAB Secretary, who personally handled all general arrangements for the Conventions. It included Art Stringer, who planned all exhibit details; Everett Revercomb, who handled tickets and reservations, and R. V. (Doc) Howard and Neil McNaughton, who planned and ran the Engineering Conference.

As exhibitors we participate every year in several dozen industry shows—and we think we know a well-handled show when we see one. The NAB was all of that—one of the best we've ever been in. Messrs. Arney, Stringer, Revercomb, Howard, McNaughton, and your corps of capable assistants—we salute you!

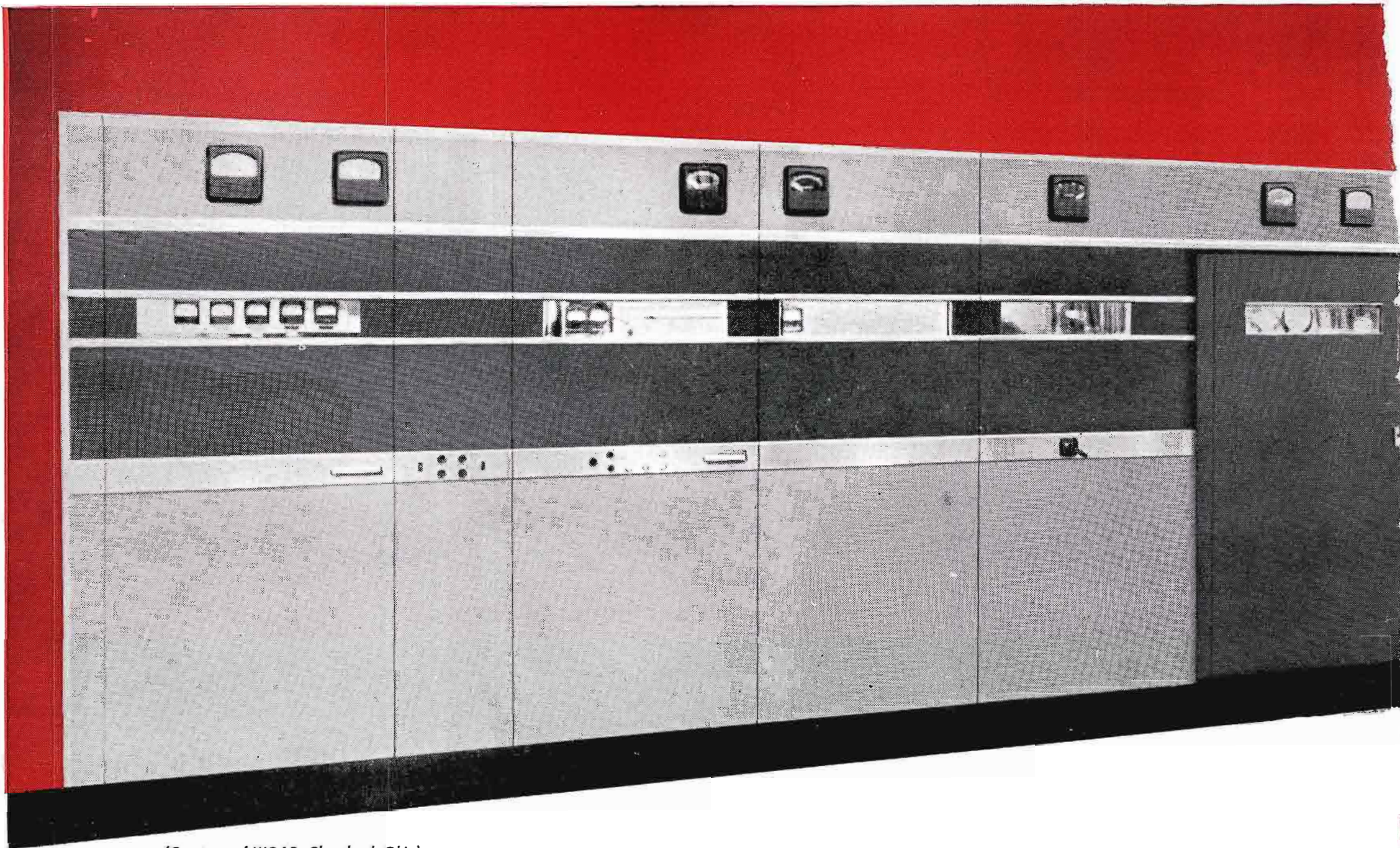

(Courtesy of WGAR, Cleveland, Ohio)

## Replace your old AM transmitter *with RCA's new 50 kw...*



The revolutionary, new power triode **RCA-5671**. This tube takes about one-third the filament power of conventional triodes used in the older transmitters. It reduces hum modulation below FCC requirements—*even without r-f feedback*.

The two 5671's in the r-f power amplifier and the two in the class B modulator of this 50-kw transmitter save up to \$1200 yearly in filament power alone.

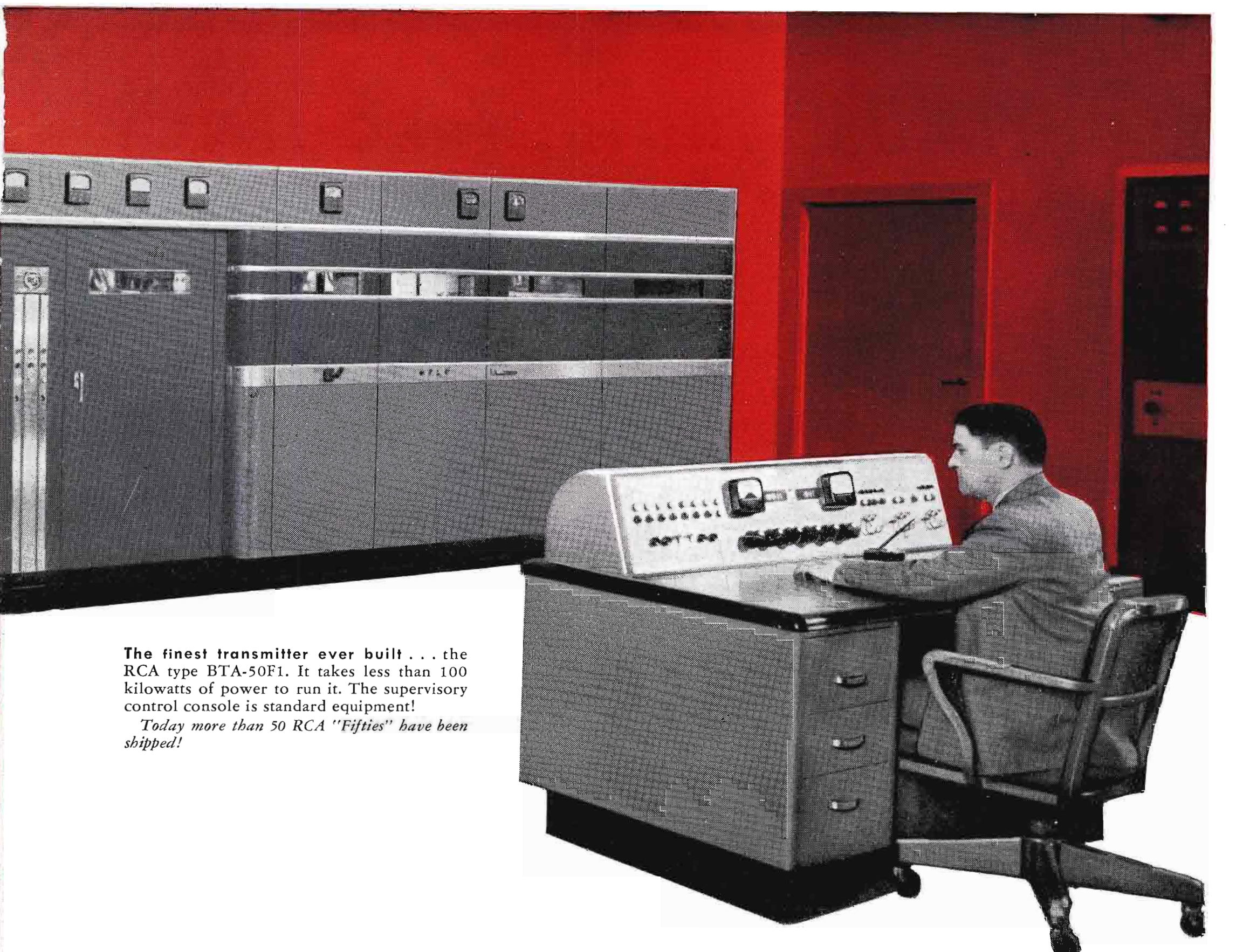

The finest transmitter ever built . . . the RCA type BTA-50F1. It takes less than 100 kilowatts of power to run it. The supervisory control console is standard equipment!

*Today more than 50 RCA "Fifties" have been shipped!*

## and write off its cost in power savings alone!

It's a fact—as one high-power broadcaster recently discovered to his complete satisfaction. Now, he has replaced his old transmitter with an RCA "fifty"—and it's paying its way.

### HERE'S WHY.

Using revolutionary new RCA-5671 power triodes that take about one-third the filament power of conventional types, this RCA "fifty" saves up to \$1.75 an hour in power savings over former transmitters—\$12,000 a year, based on daily operation at 19 hours a day!

Many other new design features, too, that add to this \$12,000 savings.

*For example, only 29 tubes and 11 different tube types—less than half the number used in many present 50 kw's. True walk-in accessibility that assures faster maintenance—and lowers maintenance costs. Ultra-conservative operation of tubes and components—with less chance for outages.*

Here is a 50-kw AM transmitter that does away entirely with oil circuit breakers—assures faster circuit protection. Because the BTA-50F1 operates from a 460-volt supply. Control and protection

circuits are the most complete of any transmitter designed to date. And its true unified front (an integral part separate from compartment enclosures) facilitates flush-mounting—gives your transmitter room a new, handsome appearance.

Write for the new 28-page brochure about the BTA-50F1. It gives you complete details—including circuits, specifications, floor plans, and full-page pictures showing the remarkable accessibility of this great transmitter.

Dept. 19HC, RCA Engineering Products, Camden, New Jersey.



**BROADCAST EQUIPMENT**  
**RADIO CORPORATION of AMERICA**  
**ENGINEERING PRODUCTS DEPARTMENT, CAMDEN, N.J.**

In Canada: RCA VICTOR Company Limited, Montreal

# OPTIMUM HIGH - FREQUENCY BIAS IN MAGNETIC RECORDING

by G. L. Dimmick and S. W. Johnson

Audio Engineering Section  
Engineering Products Department

A high-frequency bias for magnetic recording was first used by W. L. Carlson and G. W. Carpenter in 1921. Since that time there have been differences of opinion regarding the exact cause of the improved linearity and lower distortion produced by this type of bias. Many people subscribe to the theory that the action of the high-frequency magnetic field is to keep the molecules in a constant state of agitation and thus make them more responsive to the lower frequencies required for the recording of speech and music. Others believe that the improved results can be accounted for by the action of the combined high- and low-frequency magnetic

fields upon the normal magnetic characteristics of the material in question. Toomin and Wildfeuer<sup>1</sup> attempted to explain the action of a high-frequency bias upon a sound-recording system using a recording medium having permanent-magnet characteristics. Later, Holmes and Clark<sup>2</sup> gave a different explanation of the same phenomena and showed how a magnetic-recording system is analogous in some respects to a push-pull amplifier. The writers of the present paper are of the opinion that the theory advanced by Holmes and Clark adequately explains the observed performance of a magnetic-recording system when various amounts of high-frequency bias are used. The purpose of this paper is to review briefly the above-mentioned theory and to show the effects of high-frequency bias upon the total harmonic distortion, the frequency response, and the output level for four coated magnetic tapes.

positive and negative directions from the magnetically neutral point  $O$ . The curves  $F$  and  $G$  are the ones with which we are most concerned, since the material does not pass through a major loop during the recording process. A high-frequency sine wave  $L$  of amplitude  $S$  has superimposed upon it lower-frequency waves  $E$  and  $D$  which are identical and which represent the speech or music being recorded. It is assumed that the magnetic material on which a record is to be made is in a magnetically neutral state before it comes under the influence of the recording head. As a particular point on the magnetic tape approaches the recording air gap, it is magnetized along a series of minor loops which occur at the frequency of the bias. These loops start at point  $O$  and progress up curve  $F$ . The amplitude of the minor loops increases until the point on the tape reaches the entering edge of the recording gap. The minor loops remain constant in amplitude during the passage across the recording air gap, but they may vary in position if the amplitude of the low-frequency recorded signal varies appreciably during the time the point on the tape is passing across the gap. When the point leaves the gap, the amplitude of the minor loops starts decreasing and finally reaches zero. If the amplitude of the recorded signal was of such value as to cause the ends of the

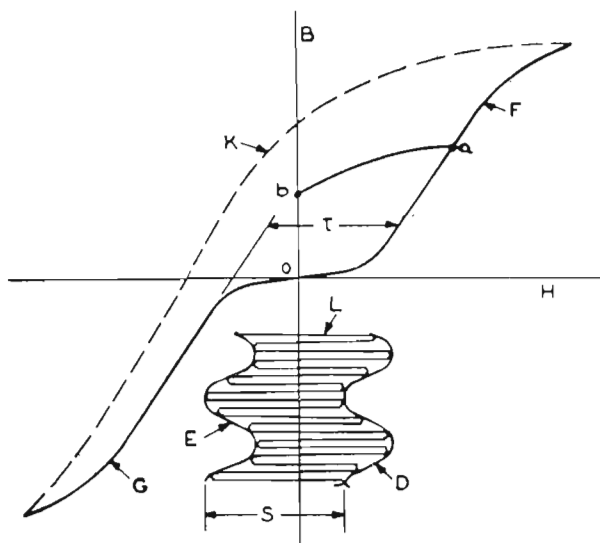

FIG. 1. Wave diagram illustrating how virgin tape is modulated.

Fig. 1 is a simplified diagram showing how the high-frequency bias acts to reduce distortion and noise reproduced from a permanent-magnet recording medium. The dotted line  $K$  shows one half of one of the major hysteresis loops for the magnetic material. The complete loop is symmetrical about the point  $O$ . The solid lines  $OF$  and  $OG$  represent the virgin characteristics of the material plotted in both the

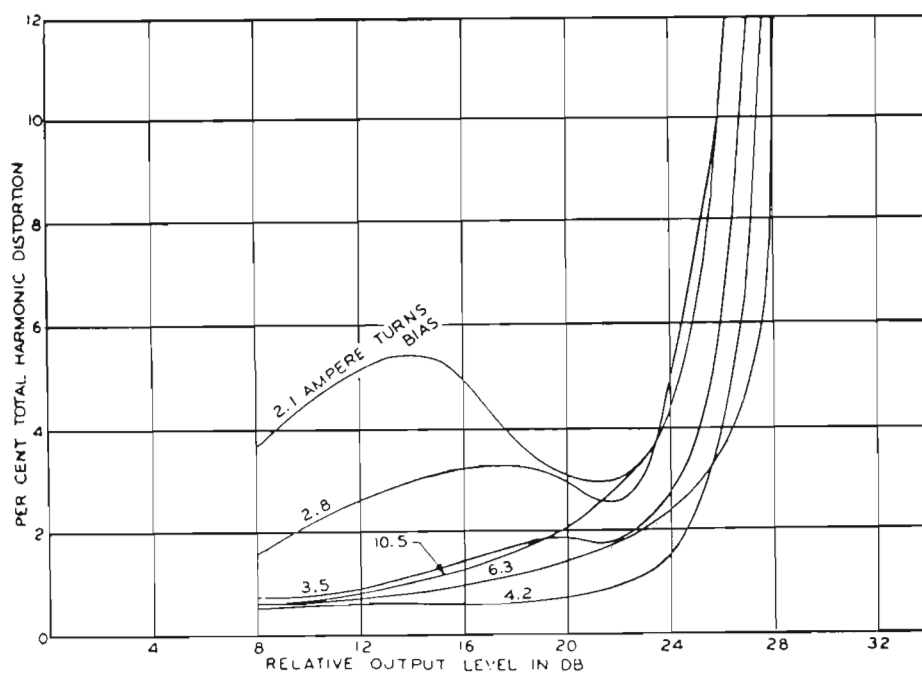

FIG. 2. Curves showing distortion versus reproducing level (German Type C tape).

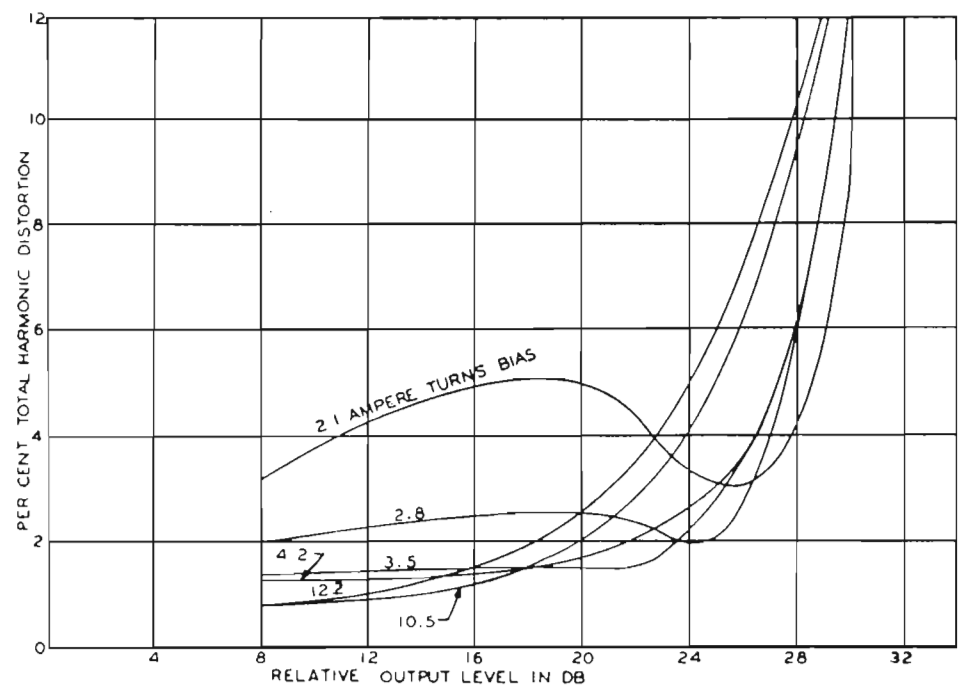

Fig. 3. Distortion versus reproducing level (duPont SW4 tape).

minor loops to reach position *a* (Fig. 1) when the point on the tape reached the exit edge of the gap, the loops would then decrease in amplitude and recede down curve *a-b* until point *b* is reached. This is the residual induction left in the tape at the particular point in question after it has passed over the recording head.

From Fig. 1 it can be seen that one of the functions of the high-frequency bias is to eliminate the effect of the "kink" in the normal characteristics of a permanent-magnet material. This can be done if the amplitude *S* of the high-frequency bias is about equal to the distance *t* between the straight portions of the curves *F* and *G*. Another very important function of the high-frequency bias is to reduce noise from the reproduced signal. It is well known that the amount of noise reproduced from a magnetic-recording medium increases with the residual induction left on the medium after recording. This noise is of a random nature and sounds to the ear very much like thermal noise from a resistor, or like "shot effect" from an amplifier tube or phototube. The ear is very sensitive to this type of noise when there are no other reproduced signals to mask it. The high-frequency bias, therefore, serves the important purpose of keeping the recording medium in a magnetically neutral state when no signal is recorded.

In order to determine experimentally the effect of high-frequency bias upon distortion and output level, a 1/4-inch tape recorder and reproducer was so arranged that many of its characteristics could be held constant throughout the tests. The tape speed was set at 15 inches per second, and the over-all frequency characteristic was adjusted to be flat within 1 decibel from 50 cycles per second to 10,000 cycles per second when using German Type C tape with the bias set at its optimum value. The frequency of the bias was 100 kilocycles. The recording characteristic was flat from 50 to 3000 cycles per second and rose 10 decibels between 3000 and 10,000 cycles per second. Three-foot loops of each of the tapes were used for the tests, and the recorded material was continuously erased before new material was recorded. The erasing frequency was also 100 kilocycles. Ring-type heads of RCA design were used for recording, reproducing, and erasing. The recording gap was 0.001 inch while the reproducing gap was 0.0005 inch. The total distortion introduced by the recording and reproducing amplifiers was about 0.25 percent. A General Radio Type 732-A total-harmonic-distortion meter was used, and the distortion and output-level

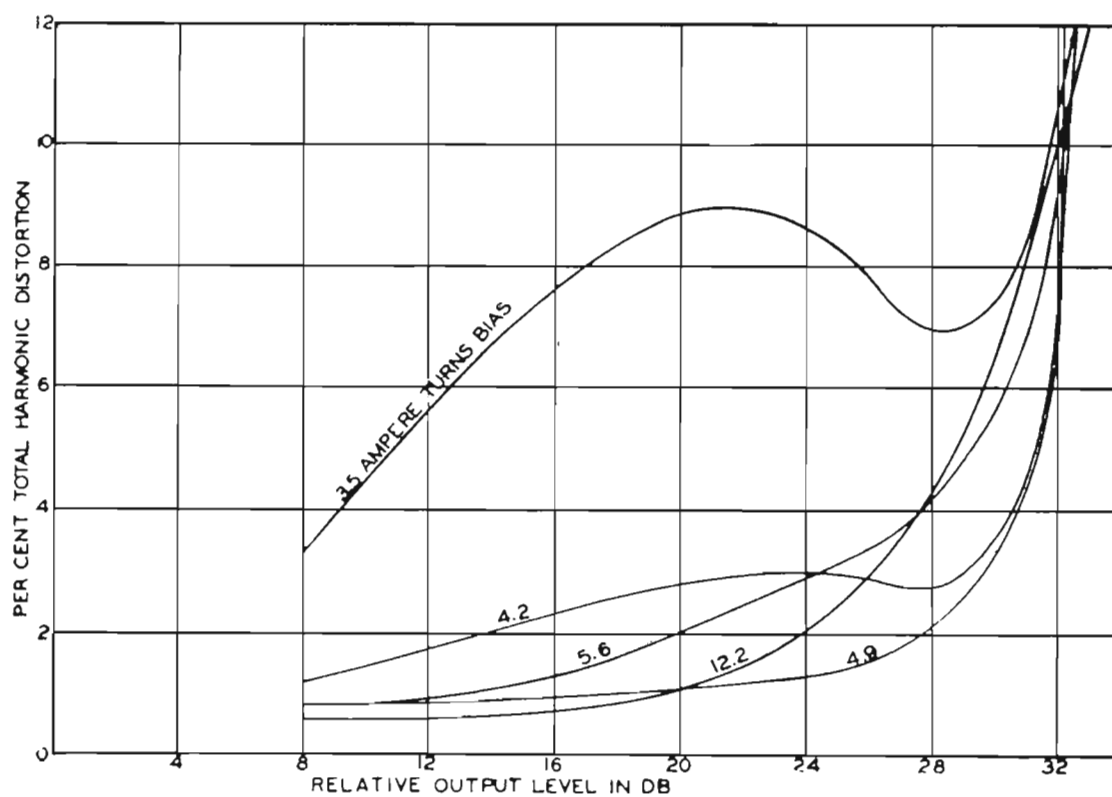

FIG. 4. Distortion versus reproducing level (Minnesota Mining black-oxide plastic tape).

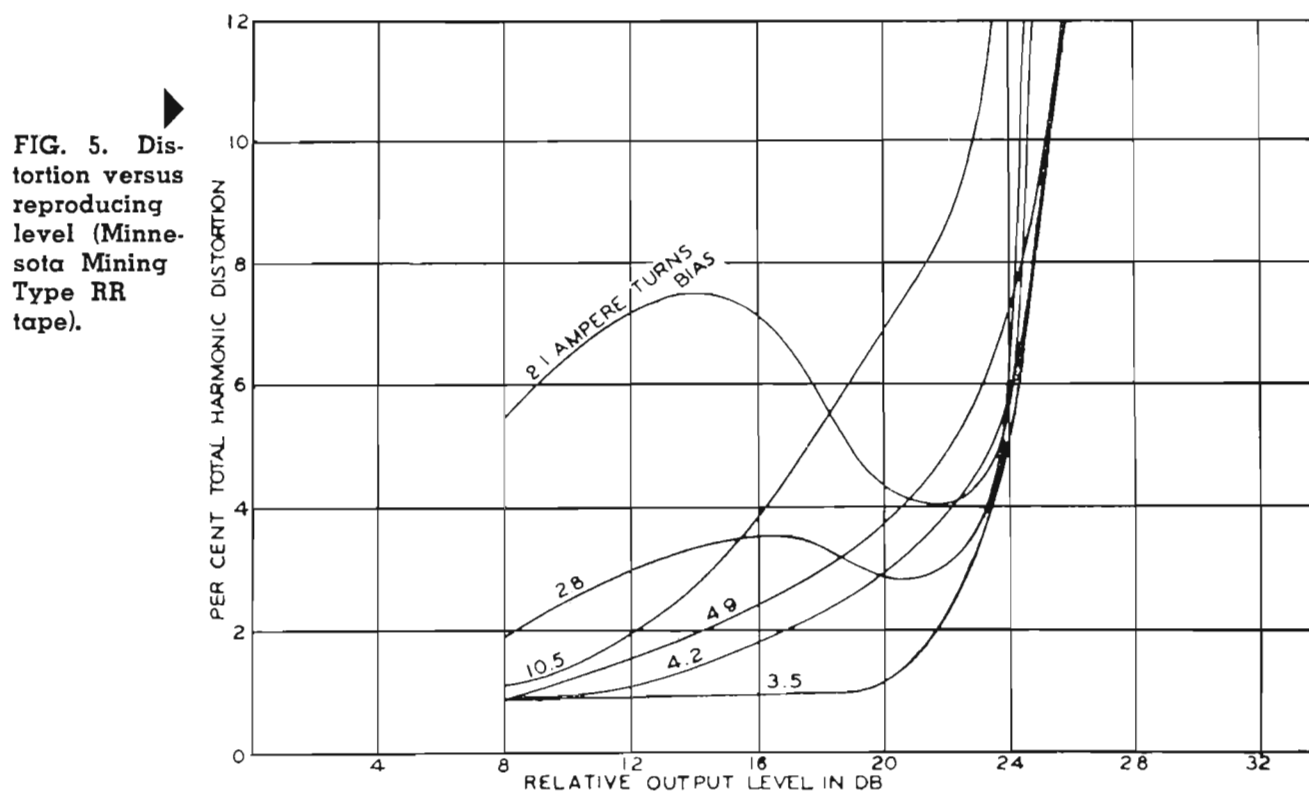

FIG. 5. Distortion versus reproducing level (Minnesota Mining Type RR tape).

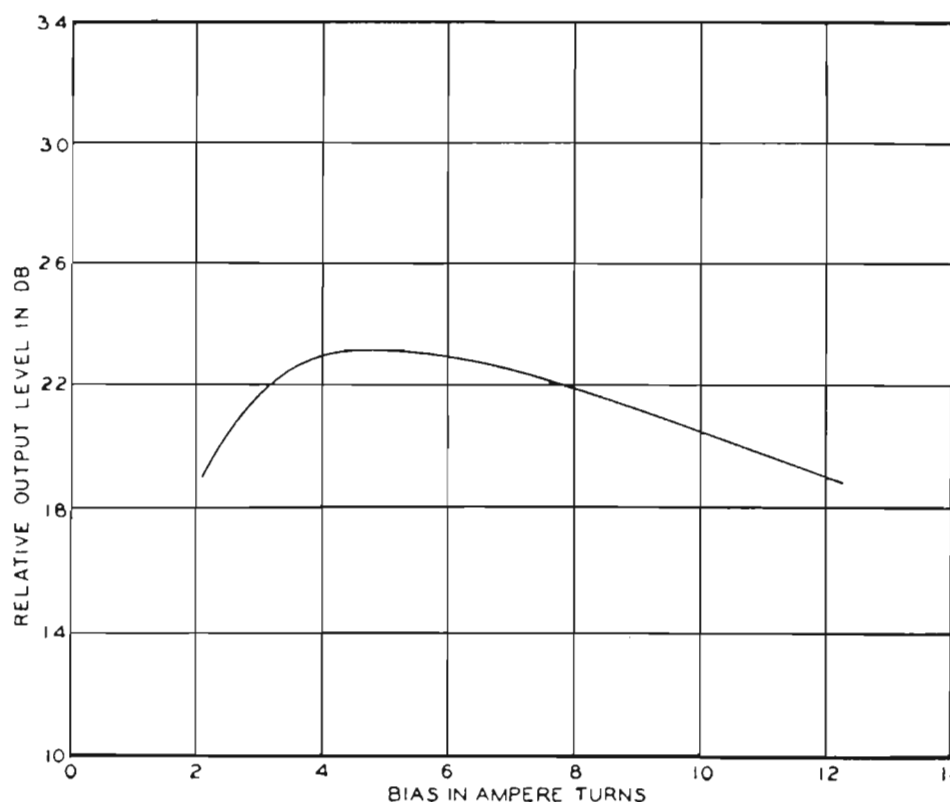

FIG. 6. Output level versus bias for German Type C tape.

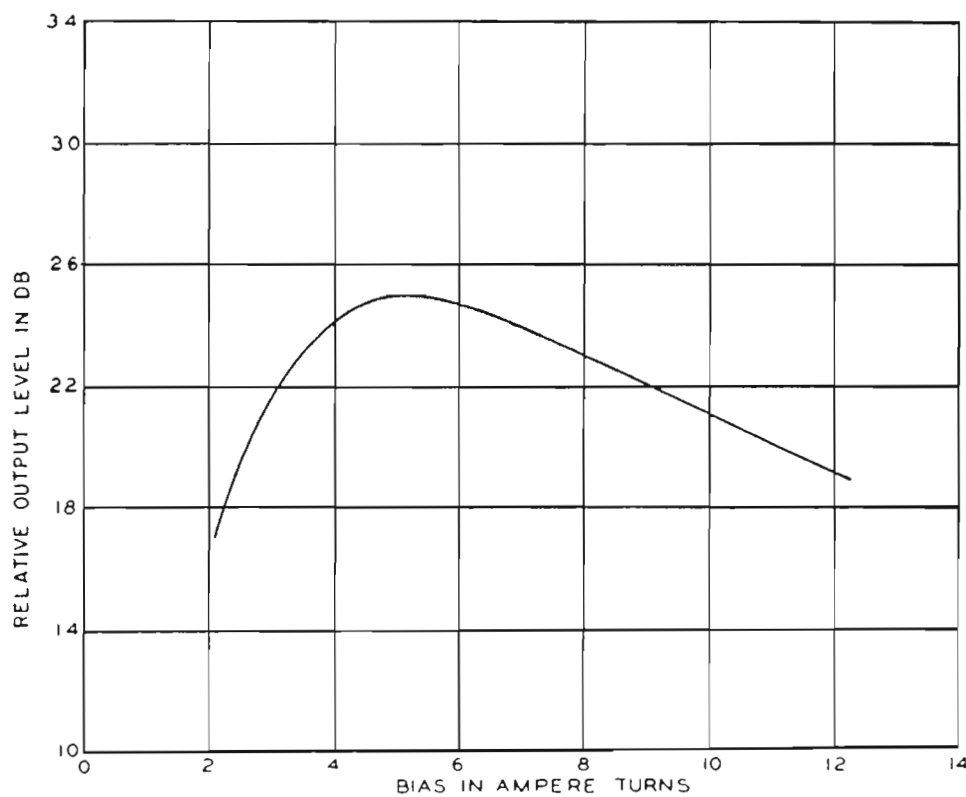

FIG. 7. Output level versus bias for duPont SW4 tape.

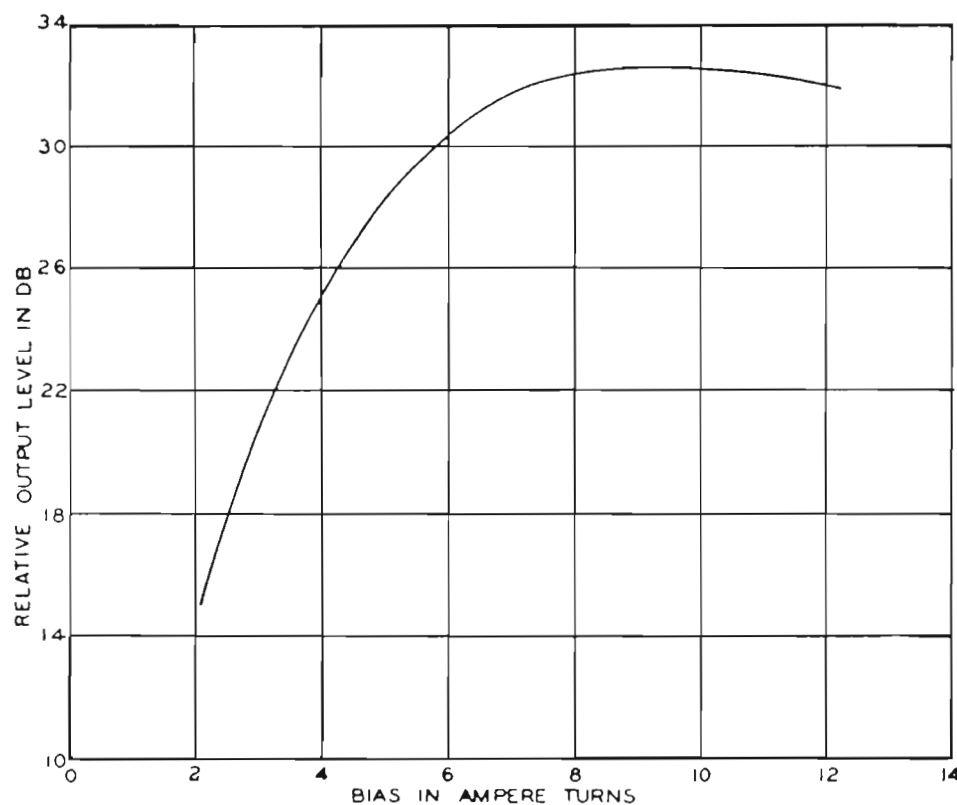

FIG. 8. Output level versus bias for Minnesota Mining black-oxide plastic tape.

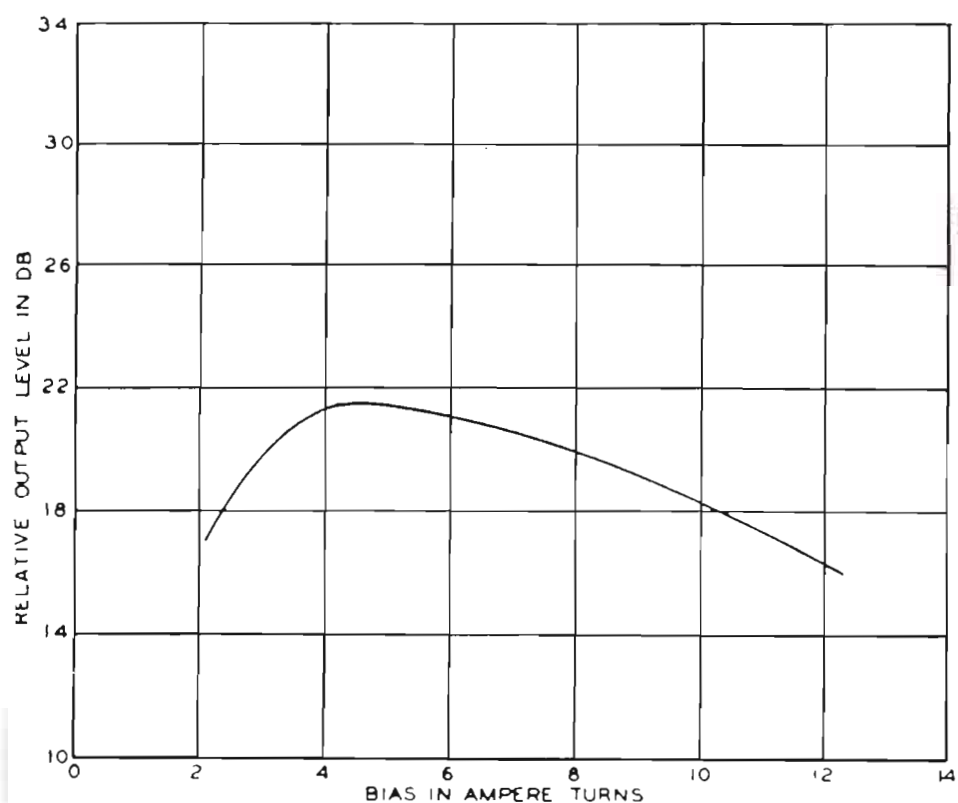

FIG. 9. Output level versus bias for Minnesota Mining Type RR tape.

measurements were made at a frequency of 400 cycles per second. The gain of the reproducing amplifiers was held constant throughout the tests, in order to have a direct comparison between the output levels for the four tapes tested. These were German Type C, duPont Type SW4, Minnesota Mining black plastic tape, and Minnesota Mining Type RR tape.

Fig. 2 shows a family of curves in which the total harmonic distortion in percent is plotted against output level in decibels for various values of high-frequency bias. This family of curves was made with German Type C tape under the test conditions described above. A range of bias values extending above and below the optimum value was chosen. It is quite apparent that the curve made with a bias of 4.2-ampere turns will result in the greatest output with the least distortion. The distortion is less than 1 per cent for output levels below 22.5 decibels, after which the curve breaks sharply. For higher or lower bias values, the distortion is greater for a given output level.

In view of the explanation of the recording process based upon Fig. 1, it seems reasonable to expect the distortion curves to be as they are shown in Fig. 2. For low values of bias we should expect the distortion to be relatively low for small recorded-signal amplitudes. This is because the curve *GOF* (Fig. 1) is relatively straight where it passes through the point *O*. When the signal is increased until the peaks extend beyond the toe portions of curves *G* and *F*, the distortion will reach a maximum value. For still greater values of recorded signal the distortion will decrease because the distortion effect of the "kink" in the curve *GOF* will become a smaller percentage of the total signal. For even greater values of recorded signal, the distortion will rise again because the peaks of the waves will begin to occupy the "knee" positions of curves *G* and *F*.

It is assumed that the best value of bias is the one which just eliminates the "kink" in the over-all characteristic and results in a constant slope through the origin *O*. Any further increase in bias results in the slope being greater near the origin, and it also results in a reduction in the total effective length of the characteristic curve, due to partial erasing. These two effects account for the fact that for high values of bias the distortion is increased and the overload level is decreased.

It should be pointed out here that the absolute values of the output levels and bias values shown in Figs. 2 to 9 have no significance. A bias of 1.0-ampere turn used with a recording head of one design would not necessarily produce the same effect as the same bias value used with a recording head of another design. Since in this case the same recording head was used throughout the tests, the numerical values of bias are necessary in order to compare one tape with another. The gain of the reproducing amplifiers was held constant throughout the tests in order to make it possible to compare output levels for different tapes.

Fig. 3 shows a family of output-versus-distortion curves for duPont SW4 tape. It may be seen that the best bias value is 3.5-ampere turns. Comparing Fig. 3 with Fig. 2, it will be observed that the overload levels (for optimum bias) are about the same for German Type C and duPont SW4 tape. The distortion values below overload are, however, appreciably higher for the duPont tape.

Fig. 4 shows a family of output-versus-distortion curves for Minnesota Mining black plastic-base tape. It will be



observed that the best bias value is 4.9-ampere turns, which is somewhat higher than for the other two tapes. If we arbitrarily assume the overload point to occur at 3 percent distortion, the overload level (for optimum bias) of Minnesota Mining black tape is 4 decibels higher than for German Type C tape. It will be noticed that the curve for 5.6-ampere turns is much poorer than for 4.9-ampere turns. At 12.2-ampere turns, the curve gets better again but not so good as for the optimum bias. The overload point drops  $3\frac{1}{2}$  decibels when the higher bias value is used, but this level is still higher than for the German tape.

Fig. 5 shows a family of output-versus-distortion curves for Minnesota Mining Type RR tape. The best bias value occurs at 3.5-ampere turns, which is the same as for duPont SW4 tape. The overload level (for 3 percent distortion) is 3 decibels lower than for German Type C tape and 7 decibels lower than for the Minnesota Mining black plastic-base tape. The Type RR tape has compensating advantages over the black type in that it is much easier to erase, requires a lower bias value, and has a lower noise level.

The effect of bias current upon output level for four different tapes is shown in Figs. 6 to 9, inclusive. These curves were made with a constant recording level, and the output level is plotted as a function of bias in ampere turns. The recording level was set to give an output level of 23 decibels for German Type C tape, 23 decibels for duPont SW4, 28 decibels for Minnesota Mining black tape, and 21 decibels for Minnesota Mining Type RR tape. By comparing values on Figs. 2 and 6, it can be seen that for German Type C tape the bias value required for lowest distortion is the same value required for maximum output level. This is a very desirable condition because it means that slight variations in bias about its optimum value will not cause corresponding variations in the output level. For duPont SW4 and Minnesota Mining Type RR tapes (Figs. 7 and 9) the bias required for least distortion occurs slightly below the point of maximum output level. For Minnesota Mining black plastic-base tape, the bias which gives the maximum output is nearly twice the value which is optimum from the standpoint of distortion.

The effect of bias upon frequency characteristic for four tapes is shown in Figs. 10 to 13, inclusive. The purpose of these curves is to show that the bias current produces some erasing of the signal and this effect is greatest at the highest signal frequencies. It will be observed that Minnesota Mining black tape is less affected by bias than the other red-oxide tapes. This is probably because the coercive force for this tape is higher and the effect of demagnetization at high frequencies is less. All three of the American-made tapes have better high-frequency response than the German Type C tape. The curves shown in Figs. 10 to 13 were made without compensation and represent the variation in output voltage of the reproducing head with recorded frequency. The current in the recording head was held constant at all frequencies.

## References

<sup>1</sup> Hershel Toomin and David Wildfeuer, "The Mechanism of Supersonic Frequencies as Applied to Magnetic Recording," *Proc. I.R.E.*, vol. 32, pp. 664-668; November, 1944.

<sup>2</sup> Lynn C. Holmes and Donald L. Clark, *Electronics*, July, 1945.

\* Presented May 18, 1948, at the SMPE Convention in Santa Monica.

FIG. 10.  
Frequency Response, German Type C tape.

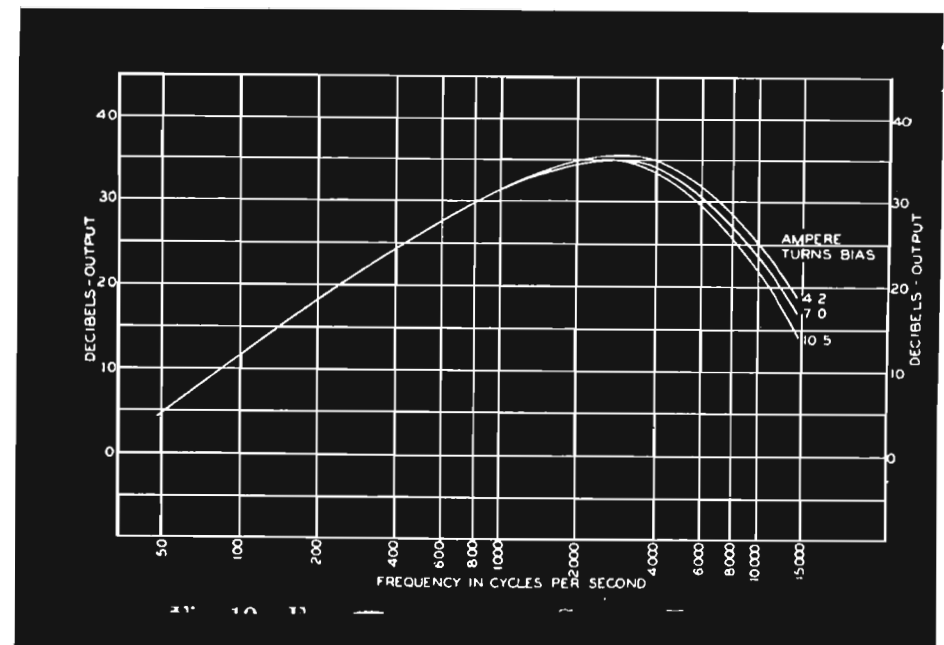

FIG. 11.  
Frequency Response, duPont SW4 tape.

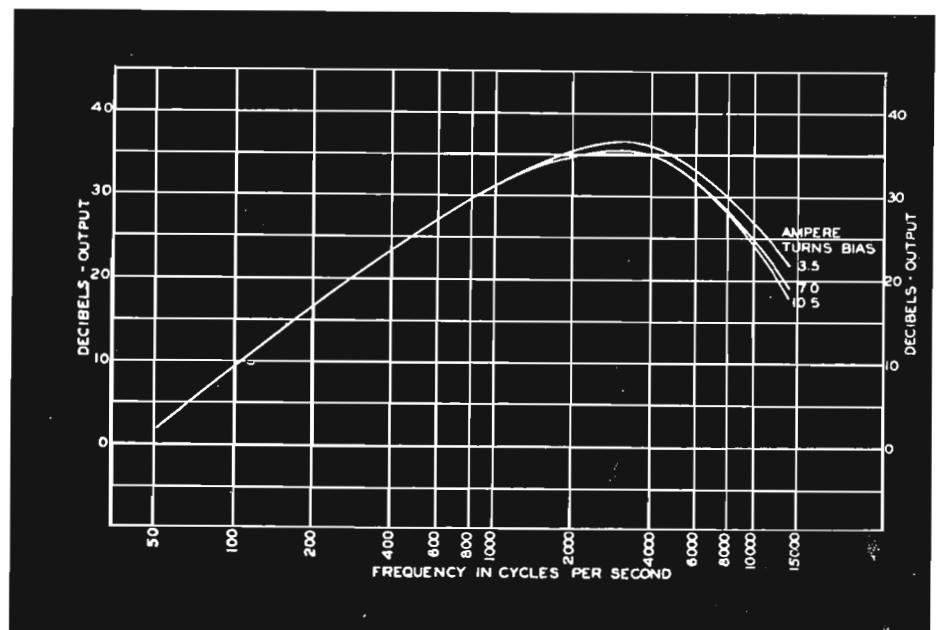

Fig. 12.  
Frequency Response, Minnesota Mining black-oxide plastic tape.

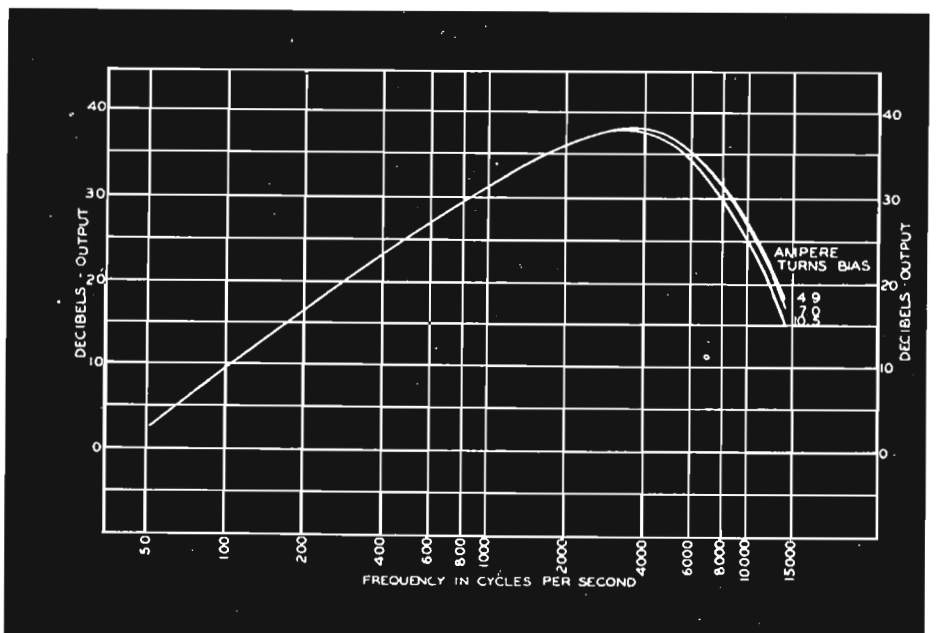
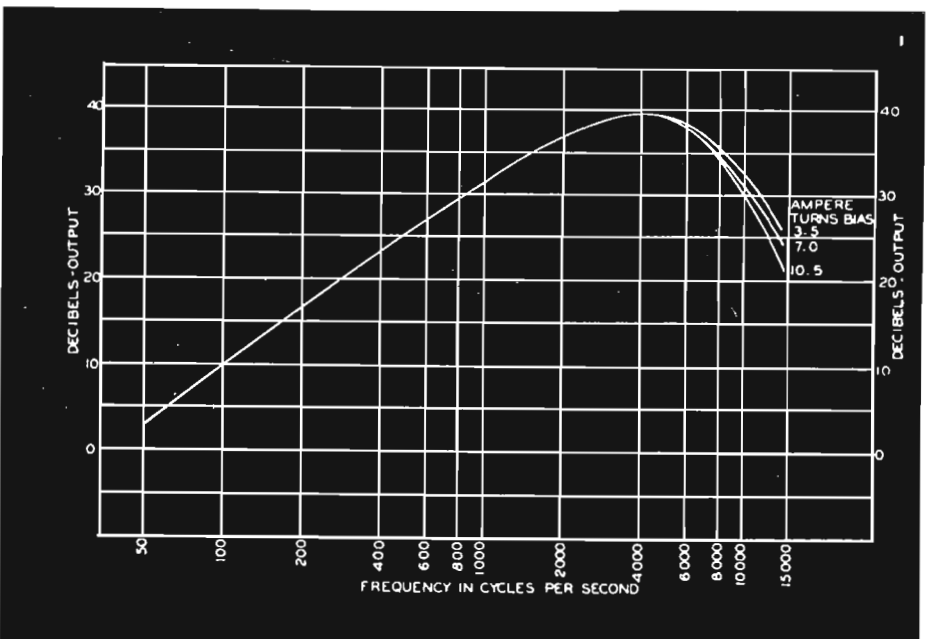

FIG. 13.  
Frequency Response, Minnesota Mining Type RR tape.



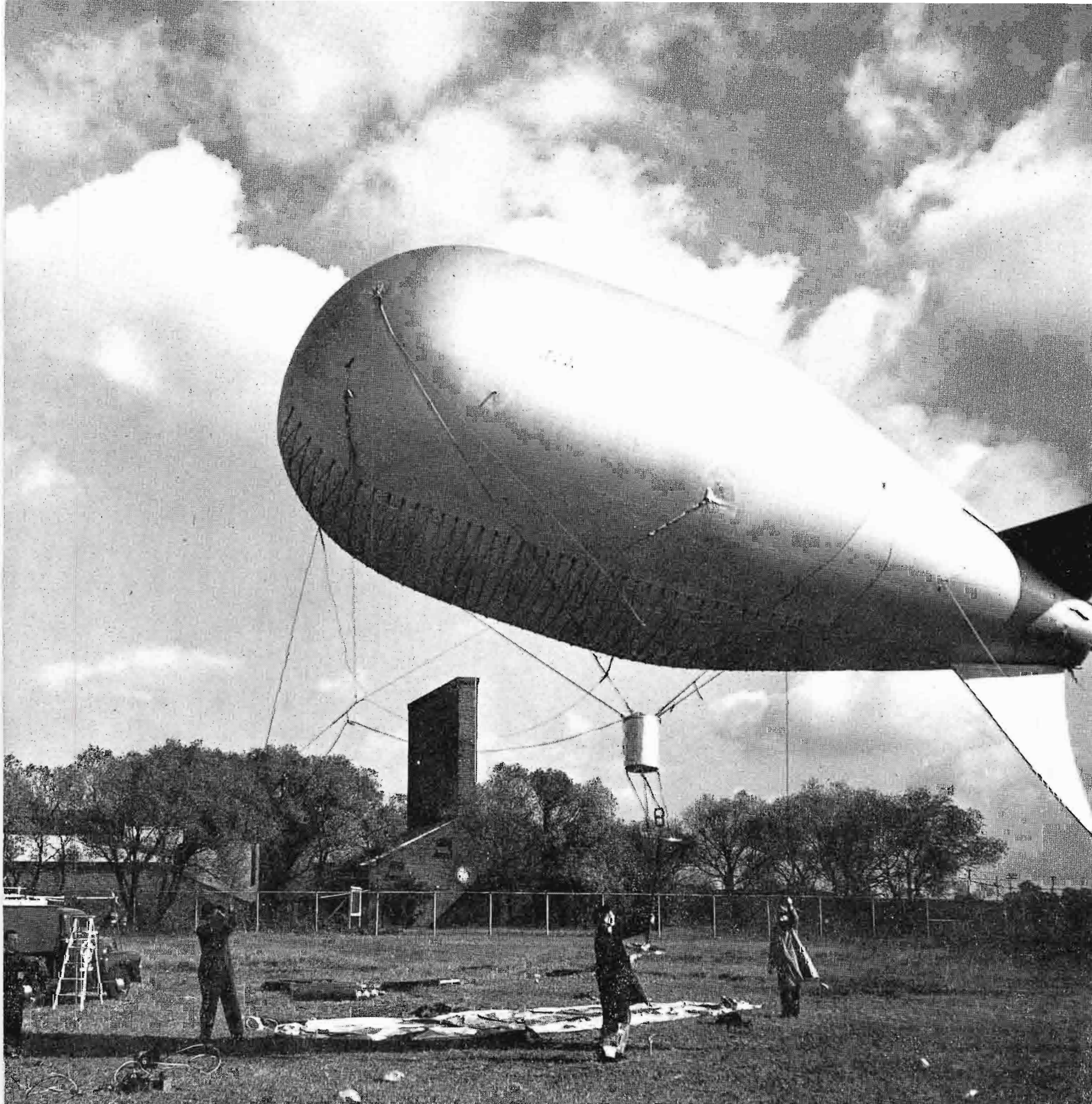

FIG. 1. During the tests a pulse transmitter with 30 KW ERP and a channel 13 antenna were suspended from a war-surplus barrage balloon. Shown above, the ground crew makes final rigging check before sending the balloon aloft.

# TV AND FM SITE TESTING

by E. S. CLAMMER AND E. M. BROWN  
RCA Engineering Products Department

Selection of the proper antenna site for a broadcasting station is definitely one of the major problems confronting prospective television and FM station operators. In a few instances, where only one really good site is available, such as the top of a tall building or a nearby hill, the choice is somewhat limited and the possibility of choosing a poor site is not very great. Generally, however, resolving the problem is

not quite so simple. A given area may offer a number of possible locations, all promising but none outstanding. What rules, or what procedures should guide one in making the selection, assuming that the relative cost for each site would be the same?

In general, the "line of sight" rule-of-thumb applies fairly well. Height, of course, is extremely important. But, if some natural prominence suitable for an

antenna location lies on the outer limits of the desired service area, it should not be necessary to risk non-uniform coverage and possible attenuation by buildings, trees, and other obstructions to obtain height.

Man-made, as well as natural reflecting objects, may send out echo signals over a wide zone, thereby degrading the service from what might otherwise be a good location.

In extremely hilly areas, one particular hilltop location might provide better service in the valleys than other equally elevated locations. It may be hard to prove this fact except by experiment.

On the assumption that the most accurate method of checking a site is to put a station on the air from the site in question, we can proceed to a consideration of the type of test signal desired.

First, we might try using a continuous-wave transmitter. This would afford information on field intensities, but in general would not furnish data regarding echoes which might be objectionable in television service.

Secondly, an actual television transmitter could be used to radiate a test pattern signal which would permit direct observation of picture quality and field intensity. This method probably would be the ideal technique, but the objections to this idea are practical ones. In order to provide direct data, the station would have to radiate power equivalent to the proposed TV station and would, therefore, be very nearly as large and expensive.

Third, a swept-frequency c-w transmitter can be used to indicate the presence of reflections, but the relative delay of the reflections is not easy to obtain.

A fourth possibility is to employ a pulse transmitter. The pulse type of signal will permit observation of field intensity. Using a special pulse receiver with an oscilloscope output indicator, the time delay between the received pulse and any reasonably long-delayed echo can be observed by radar technique. Relative strength of the echo can also be determined. The pulse technique seems to offer the greatest promise, so in our development of a practical system, we have selected this approach.

It is not an infrequent occurrence nowadays to find a television station transmitting with a power output in the order of 30 kw (effective radiated power). A small, simple pulse transmitter employing radar principles could provide this name order of power. Although it might be possible to compensate for lower test power by added gain in a receiver system, this expedient is not deemed wise. Modern television receivers approach fairly close to the theoretical optimum noise figure. Therefore, it is doubtful that a receiver could be provided which would allow a justifiable reduction in the test transmitter power. The test should furnish information of coverage in

the fringe areas; and if the test signal is obscured by noise in these areas, no accurate estimates can be made of what improvements higher power at the transmitter might yield. We, therefore, set an ERP of 30 kw as the goal for our test system, assuming an antenna power gain of two.

The problem of supporting the transmitting antenna of such a site measurement system was one of the most difficult we had to solve. Temporary masts or scaffolding could be used, but if the preliminary tests resulted in poor coverage, there would remain the problem of extending the height of these devices until satisfactory coverage could be noted. An airborne support, if practical, would overcome these problems. This support might have to operate at heights over five-hundred feet above the ground.

Since it would be impractical to have an airborne antenna fed by a transmitter on the ground, because of excessive line

losses, it would therefore be necessary that this airborne support provide sufficient lift for both transmitter and antenna. The transmitter power supply could be self-contained or be fed from the ground.

One of the most desirable characteristics which such an airborne support must possess is the ability to hover almost motionlessly for several hours at a time. The only apparatus which has been able to fulfill these requirements has been a well-piloted helicopter. Tests have demonstrated that this type of aircraft has the ability to hover—and appears to have better stability than any other airborne test platform. The lifting capacity seems to be adequate in the case of the larger machines.

One helicopter operator who uses a Sikorsky S-51 estimates operating costs in the order of \$85.00 per flying hour. The unit has sufficient lifting capability for the equipment and an operator. It also supplies enough electrical energy from its gen-

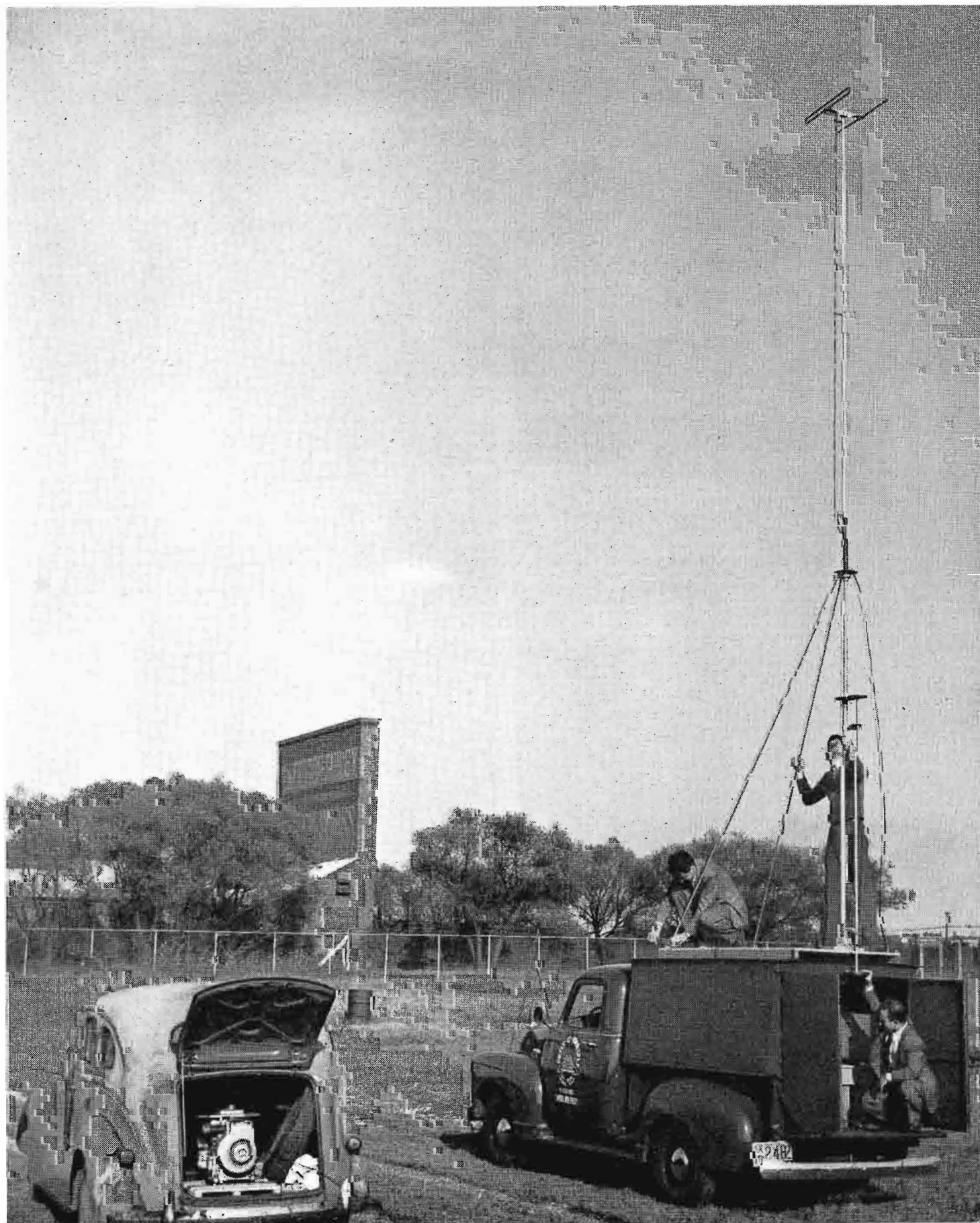

FIG. 2. A 750-watt gasoline powered generator supplied all the power necessary for the receiving and calibrating equipment located in the mobile monitoring truck.

erator to adequately fill all our power requirements. The only real drawback to the use of this type of helicopter is the fact that it is not generally available every place in the country. It is possible, however, that in the future more of the larger type machines will be available and perhaps at a lower cost.

The airborne transmitting antenna should, ideally, be equivalent in performance to the antenna which will eventually be employed. This obviously is not practical where small size and light weight are of paramount importance. An approximation of the ideal case is realized when the antenna used in the tests has enough vertical directivity to eliminate straight up-and-down radiation. Some errors may be involved through using a wider vertical angle of radiation than that of the actual

antenna, but tests have shown fairly good correlation. In general, a lower gain antenna will produce poorer results than the larger stacked arrays, thereby yielding conservatively weighted test data.

On the higher bands, two stacked loops seemed to give the desired pattern with the simplest antenna layout. On the lower bands, the loops were hard to construct, so stacked turnstiles were employed. Other configurations might well be used to achieve the same results.

The receiving setup should, of course, be mobile to facilitate rapid surveying of a large area. It should be possible to make measurements while in motion. Communications between the transmitter control point and the mobile units would be a desirable, but not a necessary feature. To facilitate a rapid survey, if costs per unit

time are considerable, multiple mobile units may permit a cost saving. For this reason, low cost and generally available standard equipment should be employed wherever possible.

The receiving antenna could be a fairly elaborate affair with extreme directivity to permit analysis of direction of arrival of echoes, or, to expedite observations while in motion, it could be relatively non-directional. Opinions differ on the best approach to this problem. The antenna height should be such that mobile operation could be used, but it should be possible to extend the antenna to the standard 30-foot elevation to make direct measurements at this height.

Unfortunately, few of the commercially available field intensity meters are suited for measurements on a pulsed signal. However, the requirements are such that an improvised setup can be made using standard components. A wide-band receiver with a pulse detector and pulse observation oscilloscope can be used as the receiving and indicating system, and a standard signal generator can be used to standardize the receiver sensitivity. Calibration of the entire system, including the vehicle and antenna, may be made in the usual fashion in a standard field of known intensity.

The techniques of pulse observation are fairly well known. A standard "synchroscope" can be used to observe the nature of the principal pulse and subsequent echoes. Delay lines permit observation of the full pulse length. Sweep rates can be chosen to display echoes to advantage.

Due to the complexity of the information to be recorded, signal intensity, number and importance of echoes, geographical location and the like, the recording system poses a serious problem which has not been completely solved. Photographic records with marginal notations seem to offer the best solution. It is not too difficult to arrange a system to record peak signal voltage on the usual chart recorder, but this often does not provide adequate information.

We have, up to this point, determined the nature of the elements which will comprise our measuring system. We have rejected some obviously unsuitable arrangements. We have made some arbitrary selections of the remaining choices. We have planned a system which, we believed,

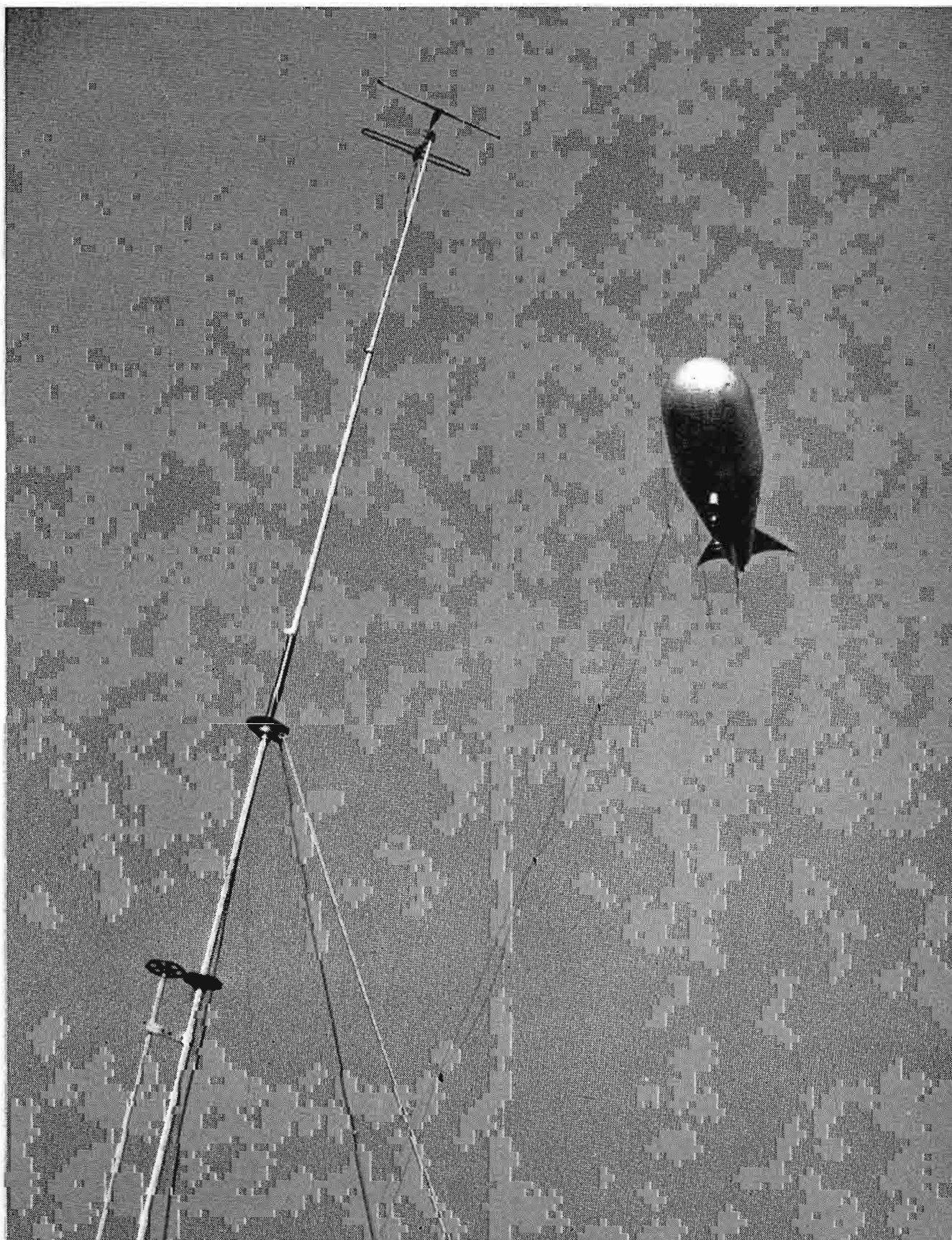

FIG. 3. In foreground photo shows receiving antenna fully extended to its 30-foot height. Balloon at right is about 150 feet high. The mooring cable tied to the balloon supports the lead which connects the ground power supply with the airborne transmitter.



FIG. 4. Photo above shows E. M. Brown, co-author, at the controls of the receiving equipment mounted in a Chevrolet truck with a plywood enclosure. Wheel at top of the picture controls antenna rotation.



FIG. 5. Shown at right is a closeup of receiving and measuring equipment which was mounted in the truck. From left to right, the units are: the standard signal generator; the modified RCA 8TS30 television receiver, and the Type WO-79B pulse oscilloscope. The RCA 8T241 picture receiver is not shown.

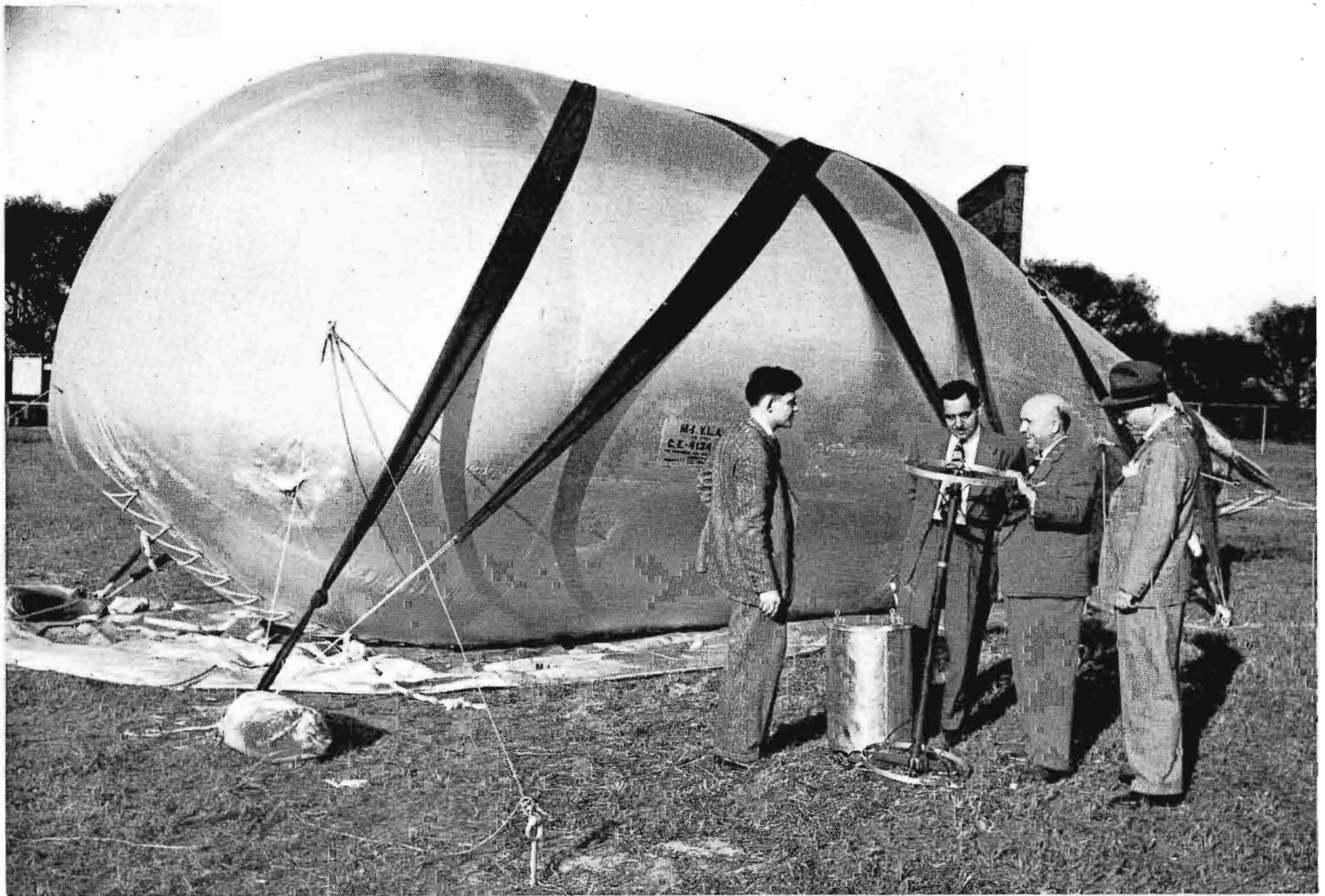

**FIG. 6.** When the helium filled balloon was not employed for tests, it was moored out of doors, as shown, without any protective cover necessary. Shown inspecting the antenna and the weatherproofed airborne transmitter, from left to right are: E. M. Brown; A. R. Hopkins, Manager of RCA Broadcast Equipment Sales; G. L. Taylor, consultant for Station KMBC; and C. M. Lewis, RCA Broadcast Field Sales Manager.

requires no radically new or untried techniques, and which could be assembled from components presently available. The remainder of this article will deal with the manner in which we applied the principles and the amount of success we achieved during our field tests.

The test transmitter was designed to produce a 1 microsecond pulse at a recurrence rate of 400 p.p.s. The transmitter was designed around a MIT model 3 hard-tube pulse modulator. This latter unit is available in limited quantities from various war surplus outlets.

The radio frequency section of the transmitter consists of two type VT-127 triodes connected in a push-pull, tuned-plate, tuned-grid, grounded-cathode oscillator circuit. Preliminary tests showed the feasibility of this circuit on television channels 2 to 13. At present, it is set up for channel 13. The specifications outlined in this report were based on measurements made on channel 13. Somewhat better performance may be expected on the lower channels.

The transmitter operates from a 400 cycle single phase 110 volt power source and consumes approximately 500 watts. The peak r-f output is approximately 15 kw.

The pulse-rate is controlled by the main power line frequency which is approximately 400 p.p.s. The oscillator is designed to feed into a balanced two-wire r-f transmission line of 300 ohms characteristic impedance. The transmitter is housed in a light cylindrical protective container, which may be suspended from a rope support or secured on a flat surface. The weight of the unit is approximately 58 pounds.

The 400 c/s main power supply was derived from a rotating machine which requires 220 volt 3 phase to drive its motor unit. A rectifier power supply supplied the required direct current for the generator field. No efforts were made to obtain a 400 c/s supply independent of the main power supply lines.

The antenna used in our tests to date has a calculated power gain of two and is

designed for channel 13. It consists of two coaxial loops, each one wavelength in circumference, spaced approximately one wavelength apart. The weight of the antenna is approximately 2 pounds. It can be suspended from a rope harness or clamped to a horizontal boom for rigid support.

Neither the transmitter nor the antenna was designed for all-weather operation, although after exposure to the elements for a reasonably long period of time, successful operation was maintained provided the units were allowed to dry before applying full power.

A 750 watt gasoline-powered single phase 110 volt 60 cycle power plant supplies all power for the mobile receiving equipment. This unit was shock mounted on a special bed and bolted to the front bumper brackets of the truck. It can be run continuously while the truck is in motion or stopped. The truck used in our tests is a Chevrolet Fleet Economy model with a plywood enclosure mounted on the steel body bed. An interphone circuit is

provided between the operator's position in the truck and the driver's seat in the truck cab.

The receiving antenna consists of a folded dipole and one reflector spaced  $\frac{1}{4}$  wavelength. Means have been provided for supporting the antenna 12 feet above the ground for continuous mobile operation. An extensible mast is also provided to support the antenna at a height of 30 feet if desired. The antenna can be rotated from the truck at either elevation. An antenna termination box provides means for feeding two receivers from one feed line. An attenuation of about 5 to 1 in voltage results when this branching circuit is used.

The pulse receiver is a modified RCA 8TS-30 television chassis which uses only the picture channel up to the video amplifier. All un-used tubes were removed during the test to minimize power consumption. To maintain the line voltage at a constant value, a variac and voltmeter were employed. The video circuits were compensated to match the input circuit of the pulse oscilloscope. A "chopper" relay was provided to supply a zero-output base line to facilitate gain measurements using a cw input signal and an oscilloscope output indicator.

The picture receiver is an RCA Type 8T241 television receiver. Except for a thorough alignment check, the receiver is a standard factory model.

The pulse observation oscilloscope is operated in the "triggered sweep" position. The delay-line built into the oscilloscope

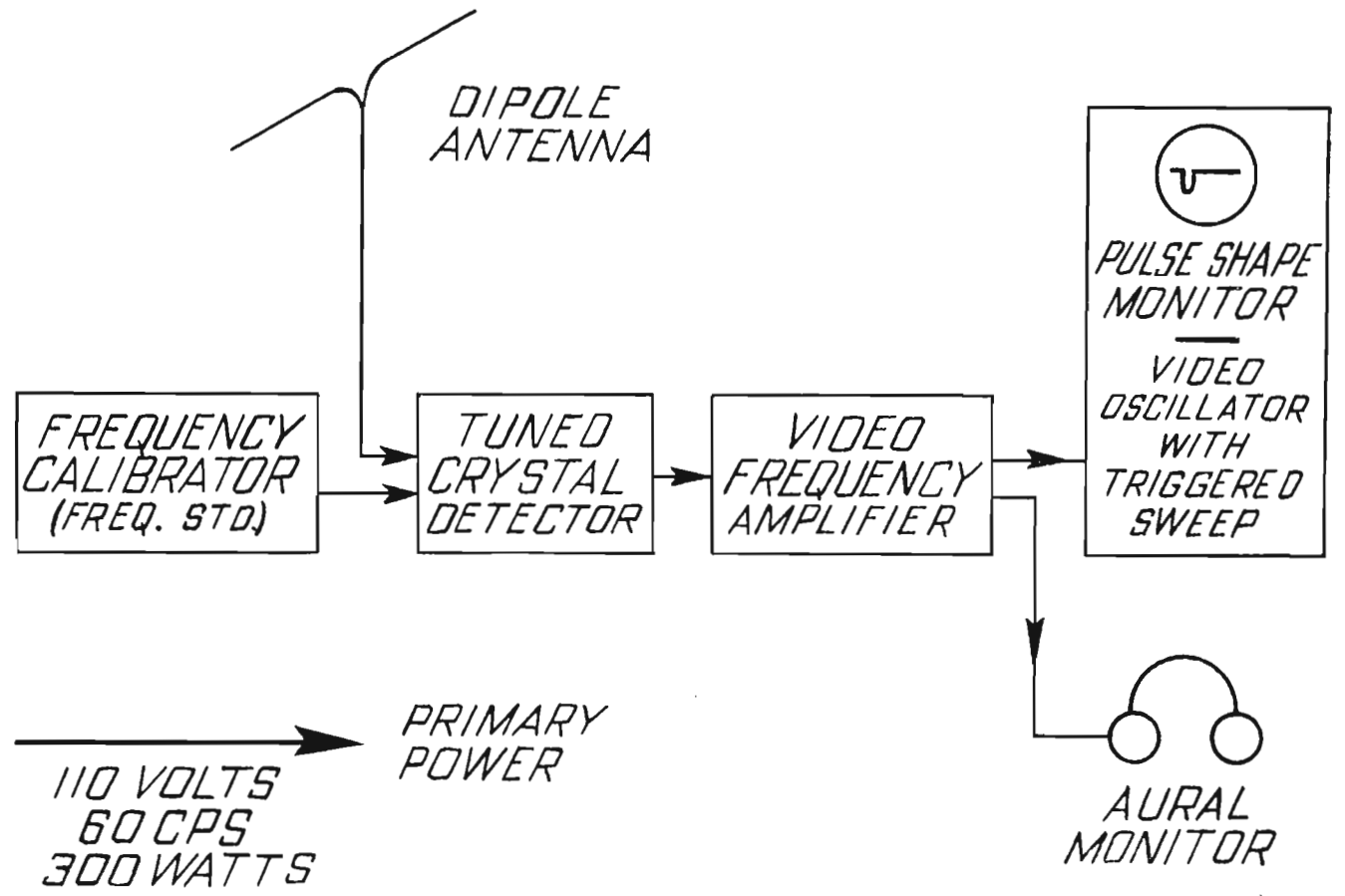

FIG. 8. This is a simplified block diagram of the transmitter monitor section. The monitor is located at ground control point to check the frequency and output of the pulse transmitter.

permits observation of the entire pulse. Minor modifications were made in the intensifier circuit to produce a brighter trace.

A standard signal generator was included to facilitate calibration of the receiver sensitivity. A terminating resistor and an "elevater" transformer were used to match the unbalanced low impedance of the generator to the 300 ohm balanced inputs of the two receivers or the branching network.

To keep constant check on our transmitter output, our system also included

transmitter monitoring equipment. A crystal detector circuit followed by a video amplifier served as a simple insensitive pulse monitor, and a resonant antenna was found convenient for insuring consistent signal pick up, while an RCA type WO-79A provided means for observing the pulse output of the pulse monitor.

An audio frequency amplifier, feeding headphones, was used to monitor signals aurally while tuning the monitor and measuring frequency.

Frequency measurements were made by feeding a c-w signal of known frequency into the pulse detector circuit simultaneously with the pulsed r-f signal. A characteristic heterodyne beat could be heard in the aural monitor when the frequencies coincided. Careful adjustment of the amplitude of the heterodyning c-w signal was necessary to get a well-defined beat. An RCA Type WR-39A Television Calibrator was found adequate for this purpose. The accuracy of adjustment was probably within a few hundred kilocycles, sufficient to maintain the signal well centered on a television channel. (Any error was due to ambiguity in the beat-note indication as a result of the wide spectrum of the pulsed transmitter.)

After the equipment was assembled, a preliminary test was necessary. This test consisted of suspending the transmitter and antenna from a war surplus M-1 barrage balloon inflated with 3000 cubic feet of helium and allowing it to ascend.

The cost of the balloon was approximately \$250. The mooring cable cost about

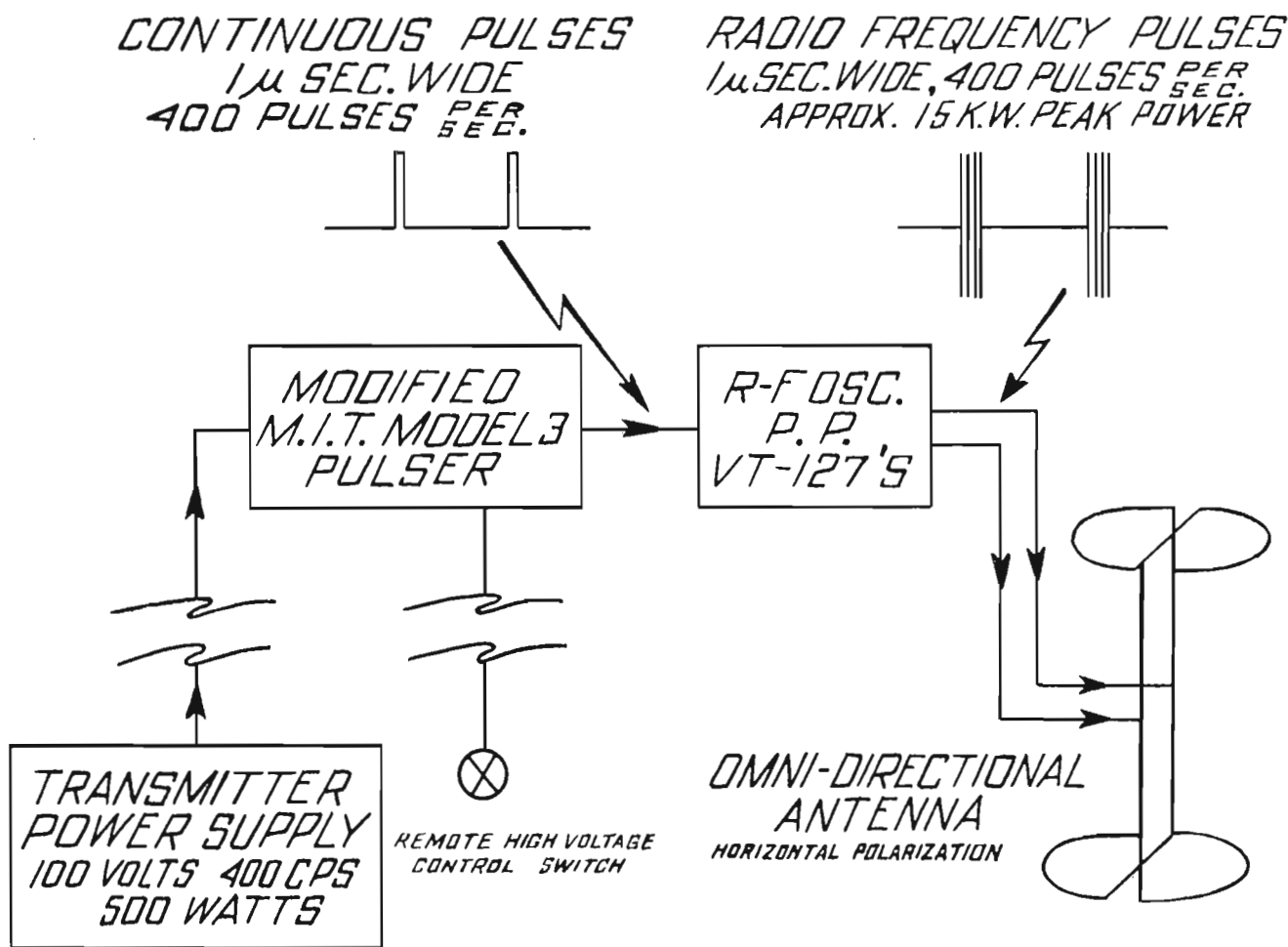

FIG. 7. Shown above is a simplified drawing of the airborne transmitter and antenna using ground power supply.

twelve cents per foot, and the winch and extra mooring ropes and stakes also added to the cost of the operation. To inflate the barrage balloon, it cost approximately \$250, and from point of time and efforts expended, it seemed impractical to recover the gas if it was found necessary to deflate the balloon. It dissipated gas at a rate of about one cylinder (\$13.50) per week and this might have been due to a slow leak.

We were able to moor the balloon to the ground without a protective housing for a period of several weeks without apparent damage, in spite of the fact that winds up to 50 miles per hour were encountered during the tests.

strength at all locations was found to vary widely due presumably to the shifting of the balloon.

This variation ran as high as 5 to 1 (in voltage) in some cases. Averaging the maxima and minima readings made at any location yielded a receiver input voltage which was in the order of the predicted value. At Cedarbrook, about 25 miles from the transmitter, an input of 300 microvolts was measured. This signal was of good enough quality to justify a prediction of good picture service at that range. No attempts were made to set up on hill tops or especially clear areas on this run.

tower in the center of Philadelphia at a point 725 feet above the street level and approximately 60 feet below the center of the WCAU-TV antenna.

In general, the field strength from our test setup channel 13 was found to be roughly 70% of that from WCAU on channel 10. Three test runs were made on as many radials. The first run was from WCAU to the Philadelphia Airport.

At the airport, both WCAU and our transmitter produced about 60,000 microvolts on the antenna feed line with the antenna 12 feet above the ground. This signal was sufficient to over-load the television receiver when the feed line was connected directly to it. The airline distance was about 6 miles. Excellent pictures were observed at this particular location. No echoes were noticed even while rotating the antenna. A clear steady picture was maintained even while driving the truck at high speed along the highway. In some obviously poor receiving locations, echoes were noted and excellent correlation was observed between the picture and pulse presentations. Two observers were used, one checking the picture and the other the pulse. In almost every case, simultaneous shouts of "echoes" were heard when a poor location was encountered. No serious transmission faults were noted on this run.

The other radials chosen extended from Philadelphia northwest to Norristown, Pennsylvania, and from Camden to Princeton, New Jersey. Good correlation between both signals were the general rule. No serious differences were noted.

A trip was also made to the region near Wyncote, Pennsylvania, from which several complaints about echoes had been received. The particular address which was first investigated showed the presence of echoes at this location. The section is shielded from the line-of-sight path to WCAU by a relatively high hill, and across the valley a higher ridge of hills receives the signal more-or-less directly. Signals reflected from prominent objects on the higher hill arrive at the Wyncote section with an intensity comparable to the main signal (Fig. 11).

Several pronounced echoes were apparent. The intensity of the echoes relative to the main wave varied widely with the position of the receiving antenna, resulting in degradation of picture quality at this location. With our antenna extended to 30 feet, the situation improved somewhat,

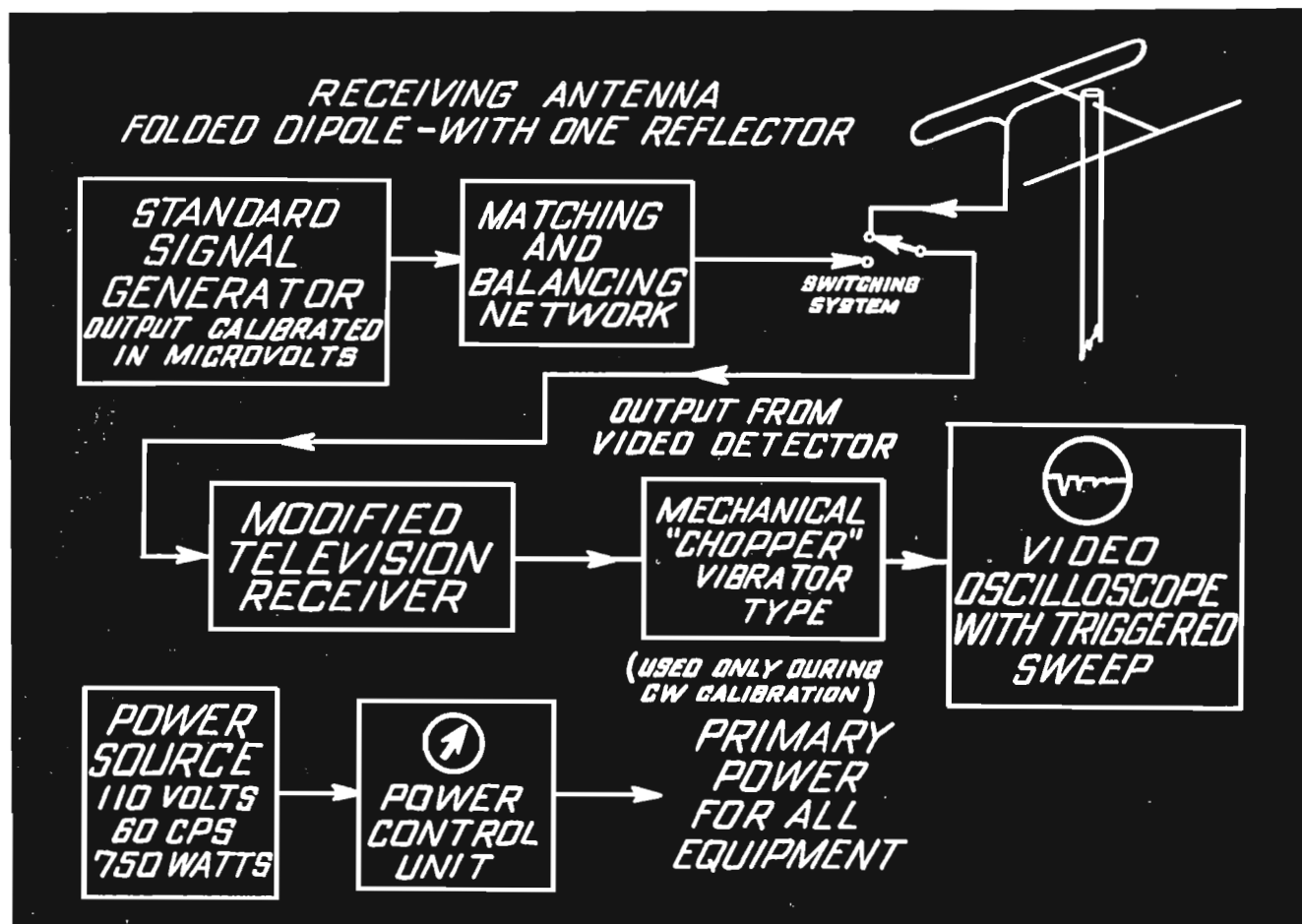

FIG. 9. Shown here is a block diagram of the mobile measuring equipment including calibration equipment which can be switched into receiver for comparison with received signal level.

Several days were then spent in checking the transmissions of the pulse transmitter by means of the mobile receiving unit. A number of fixed receiving locations were investigated. These included typical urban and suburban sites, at distance out to twenty-five miles. All the test sites, however, were located in New Jersey.

In general, it was found that no areas showed the prevalence of strong echoes, while weak echoes could be disclosed at almost any location. By properly orienting the receiving antenna, the sources of the echoes could be located. A test run was made over a radial course, through Collingswood, Haddon Township, Magnolia, Clementon, Berlin, and Cedarbrook. At each of the receiving locations a clear pulse quite free from objectionable echoes was observed on the receiver. The field

Tests made in downtown Camden showed some deterioration of pulse shape due to close-in echoes. Another variable effect was introduced by traffic moving on the street near our antenna. However, we might have predicted reasonably good picture service even under these adverse conditions.

During these tests, we had become familiar with the operation of the equipment and were satisfied that it showed a reasonable amount of promise. Our next step was to correlate our measurements against a known TV signal.

Accordingly, arrangements were made through the cooperation of the management and Engineering Department of WCAU-TV in Philadelphia for the use of their facilities. The test transmitter and antenna were mounted on the WCAU-TV



but even under the optimum conditions picture quality was somewhat degraded.

The pulse measurements showed very close correlation with the picture observations (Fig. 10). The direction and distance to the major reflectors could be estimated with a fair degree of accuracy. In order to check this determination, a run was made toward the echo source, following the antenna bearing indication. As the mobile receiver approached the hills on the opposite side of the valley, the separation of the echoes and main pulse became less, and we finally arrived at a group of three large water tanks, each of which was responsible for a major echo. Other objects were also producing echoes, but the three tanks were the principal offenders. In the region around the tanks, echoes were still serious enough to cause relatively poor pictures in spite of the increased strength of the main pulse.

The tests conducted to date seem to demonstrate the essential practicability of our proposed pulse-test system. Our experimental model has not been developed to the extent where it could be considered a commercial product. It was not our objective to develop such a product, but rather to prove that the equipment could be constructed and employed to provide propagation data under actual field conditions.

Further refinement of the design would undoubtedly culminate in a practical and useful assembly of test equipment which could be used to yield quantitative as well as qualitative results, perhaps in the form of recorded data.

Our experimental setup gave reasonably good qualitative data. A trained observer could, by using this equipment, determine correctly in almost every case whether good, mediocre or unsatisfactory service would be rendered. It may well be true that the general lack of precision encountered in UHF propagation measurements will introduce so many important errors that further refinement of the measuring equipment is not justified.

It must be remembered that the data furnished by a preliminary check is not intended to supplant data taken during a final field strength survey, made on the completed installation. It is merely used to indicate approximately what results should be expected.

The applications of our proposed equipment and the degree of development required, depend on the needs of those people who are responsible for selecting transmitter sites and guaranteeing the results obtained therefrom.



FIG. 10. This photo of the oscilloscope was taken under conditions of severe multi-path reception. The main pulse (negative polarity) is shown directly below the bright dot. Note that first echo occurs during the decay time of the main pulse. This echo alone would account for distorted picture on television receivers in the home.



FIG. 11. This photograph of test pattern from television transmitter, also made under specially severe multi-path conditions, was taken at some location as that of Fig. 10. Note correlation between pulse echoes shown on the oscillogram and those shown in this photograph. (For a picture of WCAU-TV's unique "news, time and music" test pattern as received at most locations, see BROADCAST NEWS No. 54, page 52.)



FIG. 1 (above). Audio equipment in this part of the RCA display included microphones, portable and rack-mounted amplifiers, disc and tape recorders, high-fidelity speakers and audio measuring equipment.



FIG. 2 (left). The new RCA Tape Recorder, arranged so that it could be conveniently examined and operated by visiting broadcasters, was the center of interest in the audio display.

## RCA DISPLAYS OF EQUIPMENT AT

At the annual NAB Convention and Exposition in Chicago, May 6-12, RCA used 3200 square feet of floor space in the Exhibition Hall of the Stevens Hotel to show broadcast station owners, managers and engineers its complete line of studio and transmitting equipment for AM, FM and TV stations. Nearly 500 station engineers attending the Engineering Conference (May 6-9) and over 1200 owners and managers attending the Management Conference (May 10-12) took advantage of this opportunity



FIG. 3 (above). Transmitter display area, shown above, was adjacent to the audio display. In addition to AM, FM and TV transmitters and control consoles, four TV station models, built to scale, were on display.

FIG. 4 (right). One corner of the transmitter display area contained cutaway models of the grounded-grid tank circuit elements used in the RCA 5 KW and 50 KW FM Transmitter.

## COMPLETE LINE NAB CONVENTION

to examine at first hand the newest developments in broadcast equipment. Among the items of greatest interest were the new RCA Tape Recorder, a new 5 KW FM Transmitter, the Super-gain Antenna model and an operating deluxe TV studio installation.

The RCA equipment was set up in a space 100 feet long and 32 feet deep. For convenience and accessibility this space was divided into four general areas according to type of equipment; viz., audio and recording equipment





FIG. 5 (above). The television studio area looking toward the control room. In the near foreground is one of the TV station models used to show alternative equipment arrangements.

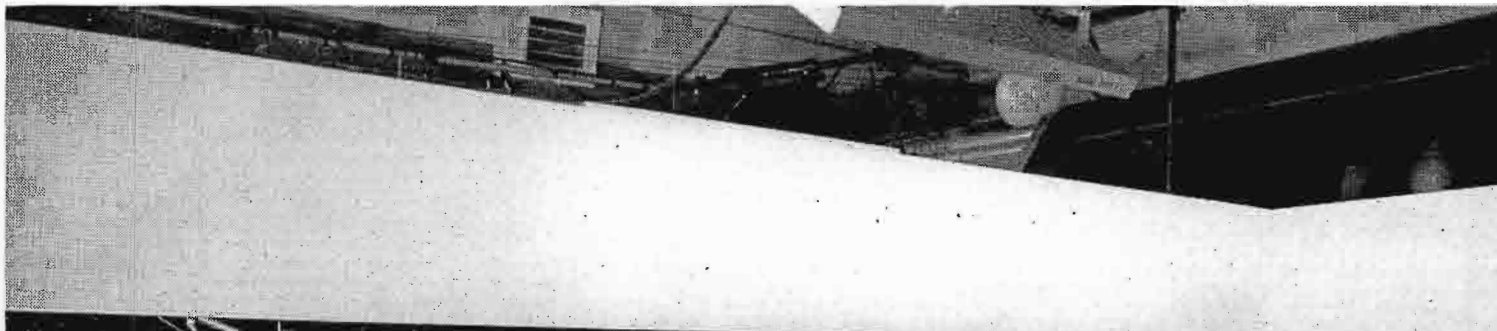

FIG. 6 (left). This is a view from within the control room looking out into the "studio" area. The video console is at the left, audio console at far right and the new director's console in the center.



(Fig. 1), AM, FM and TV transmitters (Fig. 3), TV studio equipment (Fig. 5) and TV film and kinescope recording equipment (Fig. 7).

In the audio area the tape recorder, of course, was the center of attraction. One of the portable models of this new recorder was set up so that simplicity and ease of operation could be demonstrated. A feature of the transmitter area was a model of RCA's "basic buy" for TV stations—a minimum equipment package designed for new stations in smaller markets.

Most striking display in the show was the complete operating TV studio which RCA engineers set up so that station managers and engineers might have an opportunity to study (and



FIG. 7 (above). This is the TV film equipment area. At left is the monitoring and power supply rack, in center foreground the 35mm and 16mm projectors (with film camera between). At the right is the kinescope recorder.

FIG. 8 (right). Another view of the TV "studio" area. Lighting grid, made of standard pipe fixtures, supports various types of fluorescent and incandescent lights (furnished by Television Associates and Kliegl Bros.).

actually operate themselves) this new and relatively unfamiliar equipment. The studio area (Fig. 8) contained two studio type cameras (one on a large Houston Crane). Lighting was supplied by special fixtures furnished by Television Associates, Inc. and Kliegl Brothers. Control room for the studio is shown in Figs. 5 and 6. The Control Console (Fig. 6) provided facilities for monitoring and switching four inputs (the two studio cameras, a film camera, and an off-the-air monitor). Output could be switched to several points including the kinescope recording equipment (Fig. 7). Films recorded on the latter were developed and printed in a Houston Printer, which was in operation in the RCA space during the course of the convention.

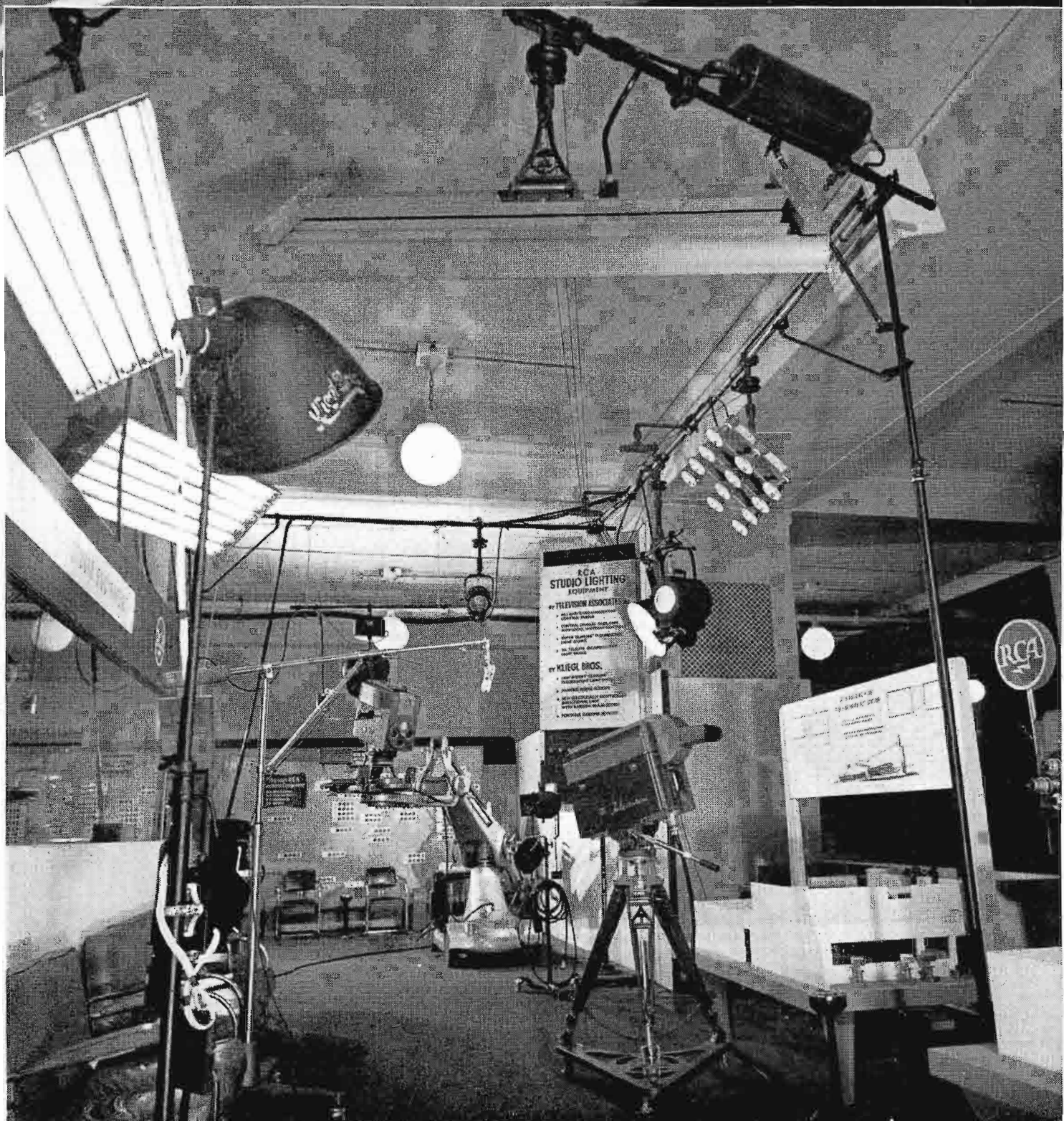

# CROSSOVER FILTER FOR DISK RECORDING HEADS

by

**H. E. ROYS**

Audio Engineering Section  
Engineering Products Department

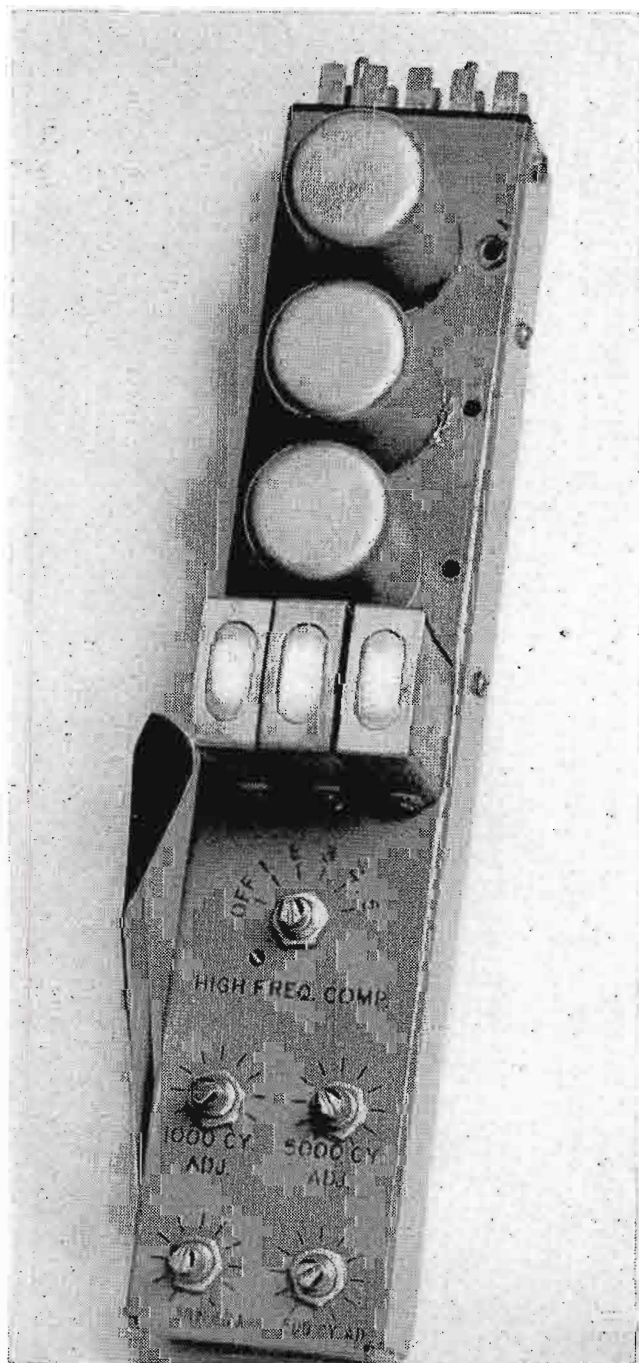

FIG. 1. Closeup view of the complete crossover filter showing adjustments. Note that the unit is of the "plug-in" type.

## Introduction

The frequency-response characteristic standardized by the National Association of Broadcasters for lateral disk recording is based upon a cutter characteristic having a transition frequency of 500 cycles. The NAB standard curve, Fig. 2, includes high-frequency tip-up having the characteristic shape of a resistance and capacitance network of such proportions that the time constant  $T = RC$  is equal to 100 microseconds ( $R$  expressed in ohms;  $C$ , in farads). Some additional low-frequency boost, below 100 cycles, is also included, as illustrated by the flatness of the curve between 100 and 50 cycles. If we subtract the 100-microsecond tip-up curve from the standard and extend the low-frequency response on a 6 db. per octave slope, we then have the characteristic of the ideal cutter—Fig. 2. Extensions of the constant-velocity and constant-amplitude portions of the curves intersect at 500 cycles, which is designated as the crossover point.

## Cutter Design

The ideal curve shows some rounding off at the crossover frequency. This is desirable from the cutter-design standpoint and also for design of the playback filter, since an abrupt change in response characteristic is difficult to obtain both mechanically and electrically. The crossover frequency of the cutter is determined by the resonant frequency of the mechanical system comprising the effective mass of the moving system and the effective stiffness of the centering means. Below resonance the mechanical system acts like a spring—constant applied force results in constant armature deflection—and hence the lower frequencies are recorded at equal amplitude. Above resonance the system is mass controlled and constant applied force results in decrease in amplitude of deflection inversely proportional to frequency, or the motion becomes constant in velocity. Mechanical damping is used to control the height of the resonance peak, and usually enough damping is included to obtain a smooth characteristic which is

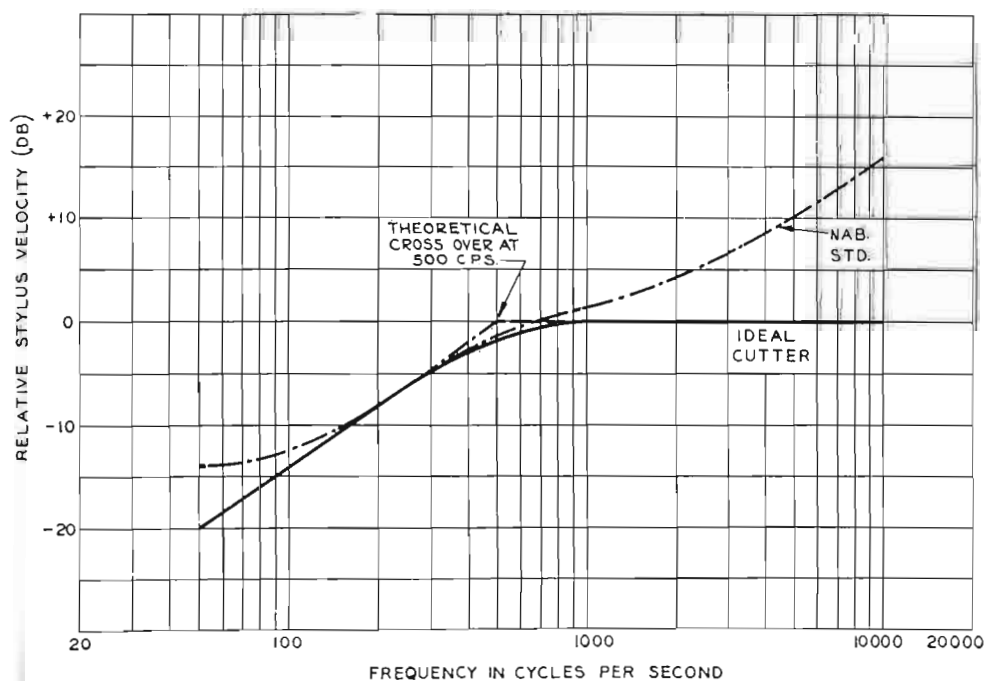

FIG. 2. NAB standard lateral recording characteristic and ideal cutter curve with crossover point at 500 cycles.

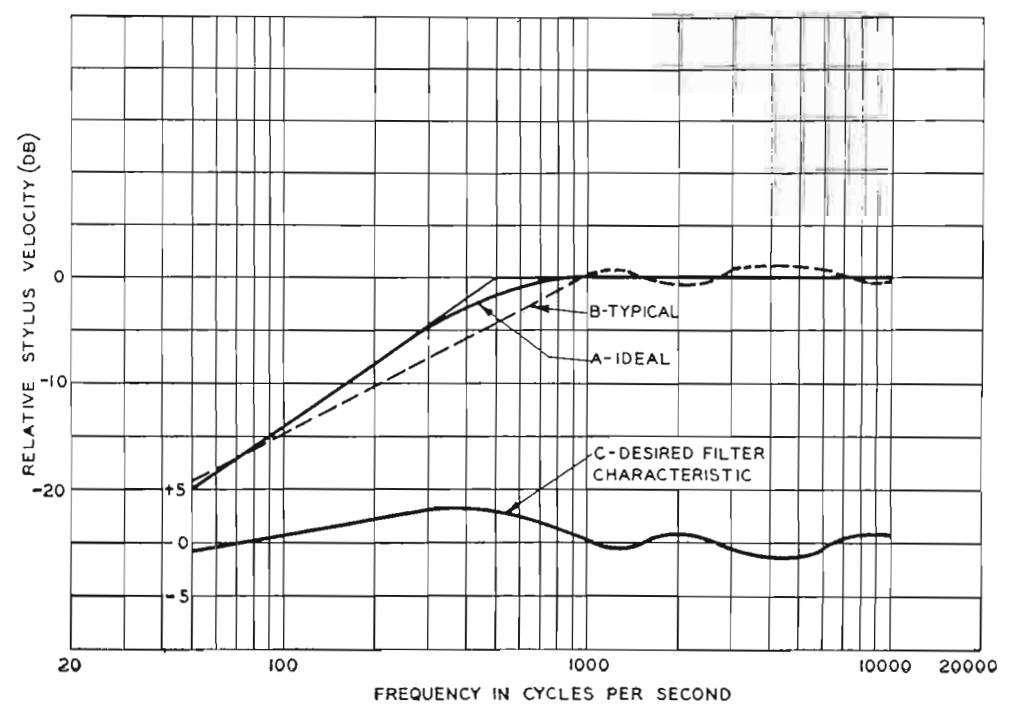

FIG. 3. Curves showing A. (ideal cutter characteristics), B. (typical response of MI-11850-C recording head—and C. (difference between A and B which gives the desired filter characteristic).

rounded off at the transition point between constant-amplitude and velocity portions. With the moving iron-vane type of cutter, it may be difficult to obtain as low crossover frequency as wanted by decreasing the resonance frequency, either by increasing the armature mass or decreasing the centering stiffness, or both, without encountering instability. The effect of the steady magnetic field provided by the permanent magnet is to act in opposition to the centering spring and attract the armature to the nearest pole piece. If the attraction is too great, centering of the armature becomes uncertain, and hence it becomes undesirable to carry this means of lowering the crossover frequency too far. Increasing the armature mass is not a desirable solution either where wide-range and maximum sensitivity (minimum driving current) is wanted, since both of these requirements call for low mass.

### Crossover Filter Design

An electrical network is a practical means of obtaining the crossover at the desired frequency and has the advantage that additional controls can be easily included for adjusting other portions of the range. A typical response characteristic of the MI-11850-C recorder while cutting lacquer is shown in Fig. 3, and if we take the difference between this and the ideal curve, we have the desired filter characteristic, Fig. 3c. Analysis of this curve shows that a tuned circuit resonated at about 500 cycles will be needed and that the drop off above resonance must occur at a faster rate than it does below resonance. For one octave above 500 cycles, or 1000 cycles, the required response has dropped 3 db.,

whereas for an octave below 250 cycles the required reduction is only about .3 db. This indicates that a circuit which will put a dip into the curve at about 1000 cycles is necessary. In order to equalize the response above 1000 cycles, a network which will put a rather broad hole in at about 4500 cycles is also needed. Response curves for a number of different cutters showed that the same type of filter characteristic was necessary, although the degree of compensation was different in each case. The filter circuit finally arrived at is shown in Fig. 4. It is designed for operation ahead of the amplifier driving the cutter and the input and output impedance is rated as 600 ohms. Input and output impedance characteristics are shown in Fig. 5 for a typical filter setting. The variation of the input impedance is slight, so that a number of filters can be bridged across a program line, using bridging transformers or bridging pads without greatly altering the line impedance. A greater variation in output impedance can be tolerated since the outputs go to individual amplifiers and are not connected together.

In many cases it was found desirable to provide some high-frequency boost, and this was accomplished by connecting capacitors across the two 300-ohm series line resistors. It was also found advantageous to have adjustable resistors in series with the capacitor and the inductance of the 500-cycle parallel tuned circuit. By having individual resistors, control of the response at the extreme low frequencies is possible without greatly affecting the boost at 500 cycles or the characteristic at the higher frequencies. Likewise, the variable resistance in series with the capacitance permits independent control at the higher frequen-

cies. Variable resistors in the series circuits, which are tuned to 1000 and 5000 cycles, provide the necessary adjustments required at these frequencies. The filter may appear somewhat complicated with so many circuits and controls, but this is believed justifiable where ease of adjustment, close tolerances, and adaptability are wanted.

### Typical Operating Characteristics

A number of cutters were selected and tried, several of which had not received final factory adjustments so that their characteristics were outside of normal limits. This was done in order to check the adequacy of the filter characteristic and range of the adjustments.

The results obtained with one of the cutters which had not received final adjustments is shown in Fig. 6. The cutting characteristic, Fig. 6a, was first measured with the aid of the FM calibrator while cutting a lacquer, and the desired filter response, Fig. 6b, then determined. Adjustments to the filter were made using an oscillator and response measurements with the filter in place obtained while cutting lacquers at both 78 and 33 $\frac{1}{3}$  r.p.m., see Figs. 6c and 6d. Since, as stated before, this cutter had not received final adjustment and the characteristic was not normal, it was found impossible to obtain a smooth, flat response throughout the high-frequency range, but it is believed that the characteristic shown would be acceptable in most cases.

The same tests were repeated with another cutter whose characteristic was more nearly normal, and a much smoother re-

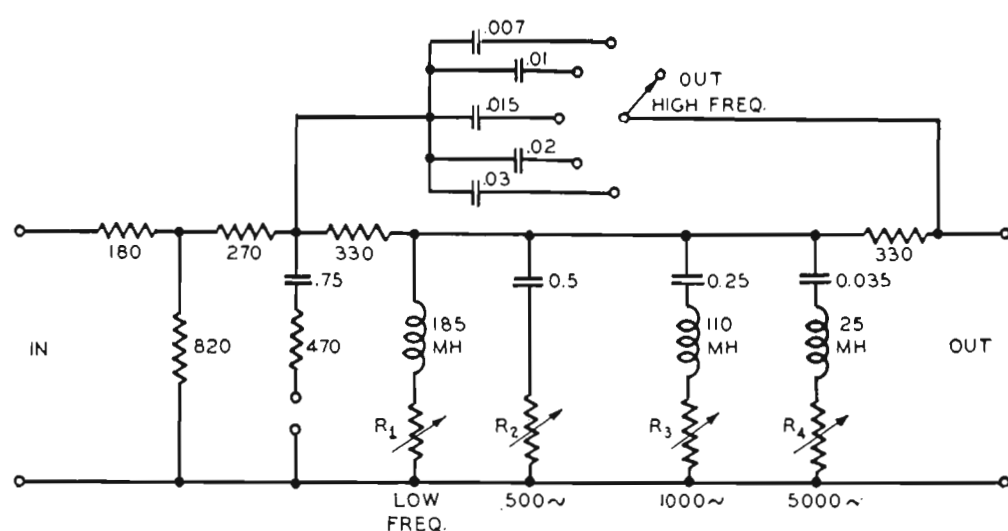
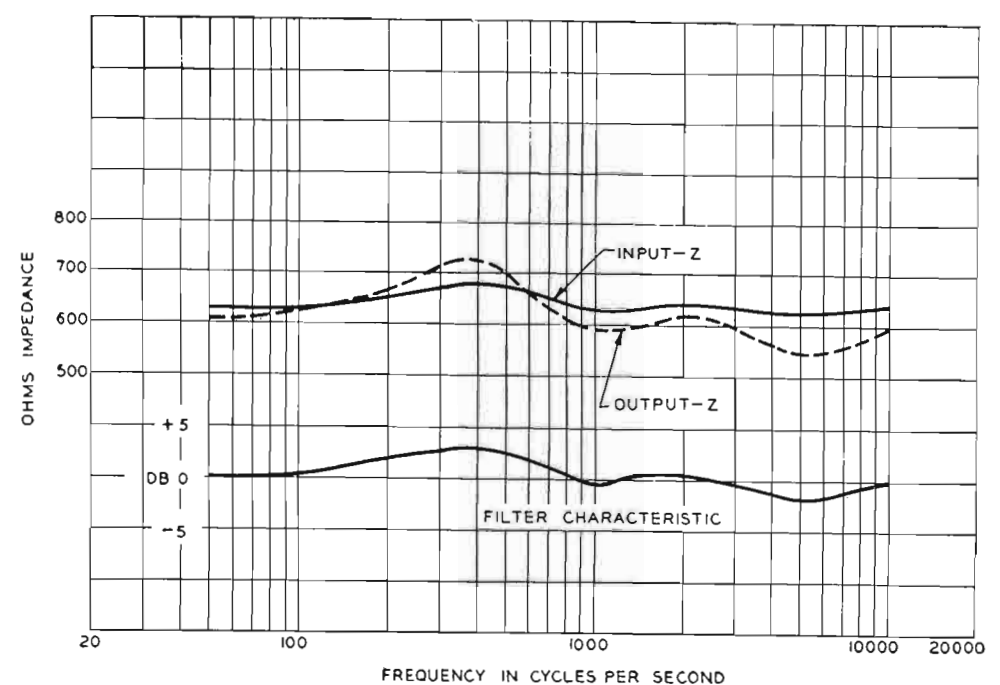

FIG. 4 (above). Circuit diagram illustrating the final filter design.

FIG. 5 (at right). Input and output impedance characteristics of the crossover filter for typical filter adjustments.



sponse characteristic was obtained, see Fig. 7.

It is interesting to note that the characteristics measured at 78 are almost identical with those obtained at  $33\frac{1}{3}$  r.p.m. A groove width of 6.5 mils was used for 78 r.p.m., since a larger playback stylus having tip radius 3 mils, is normally used for such records, whereas for  $33\frac{1}{3}$  r.p.m. recordings, the groove width is narrower, about 4.5 mils, which is wide enough to

accommodate a 2.3-mil tip normally used for transcription service. These tests indicate that the filter need not be adjusted for different turntable speeds under normal operating conditions.

Another cutter was set up, and after suitable filter adjustments, a series of response measurements was made throughout the area normally used for the 1-inch disks at  $33\frac{1}{3}$  r.p.m. These results are shown in Fig. 8, and it will again be noted

that very little variation in cutting stylus diameter. The reflected light pattern however showed considerable loss at the higher motion was obtained from 15 to  $7\frac{1}{2}$  inches frequencies, which is attributed to springback and cold flow of the lacquer medium after cutting, and possibly some bending of the stylus shank, although the FM plates were mounted low and close to the sapphire tip in order to minimize this error. The lacquer recording stylus does not have sharp cutting edges like the stylus used for recording in wax, instead the edges are polished at a slight back angle in order to form a smooth surface for pushing the material aside in order to burnish and polish the sidewalls of the grooves. Such burnishing produces grooves which are very quiet in playback. This method of shaping the stylus has become an accepted practice for lacquer recording. The burnishing surface puts some lateral load on the recording head while cutting, which has been investigated.<sup>1</sup> The high frequency loss chargeable to the burnishing<sup>2</sup> is difficult to separate from the loss due to springback or cold flow of the recording medium. Since the loss is variable depending upon the recording stylus as well as the medium, it is thought unwise to attempt to correct for it in the recording head. The only justifiable requirement that can be imposed upon the recording head is that for the same input level the stylus move the same amplitude at the inside of the disk as it does at the outside. A cutter of the true feedback type where the feedback voltage is derived from the motion of the stylus could do no better than this. Since the curves in Fig. 8 show no appreciable change in stylus motion when cutting at different diameters, it appears that another means of controlling the high-frequency loss encountered during the cutting of lacquers must be observed. Stylus and lacquer selections are possible means, and recording with increased high-frequency tip-up at small recording diameters is a practice that has been in use for many years. In fact, most lacquer recording machines constructed today provide for an attachment such as the RCA MI-11101, which will progressively raise the level of the high frequencies as the recording diameter is decreased.

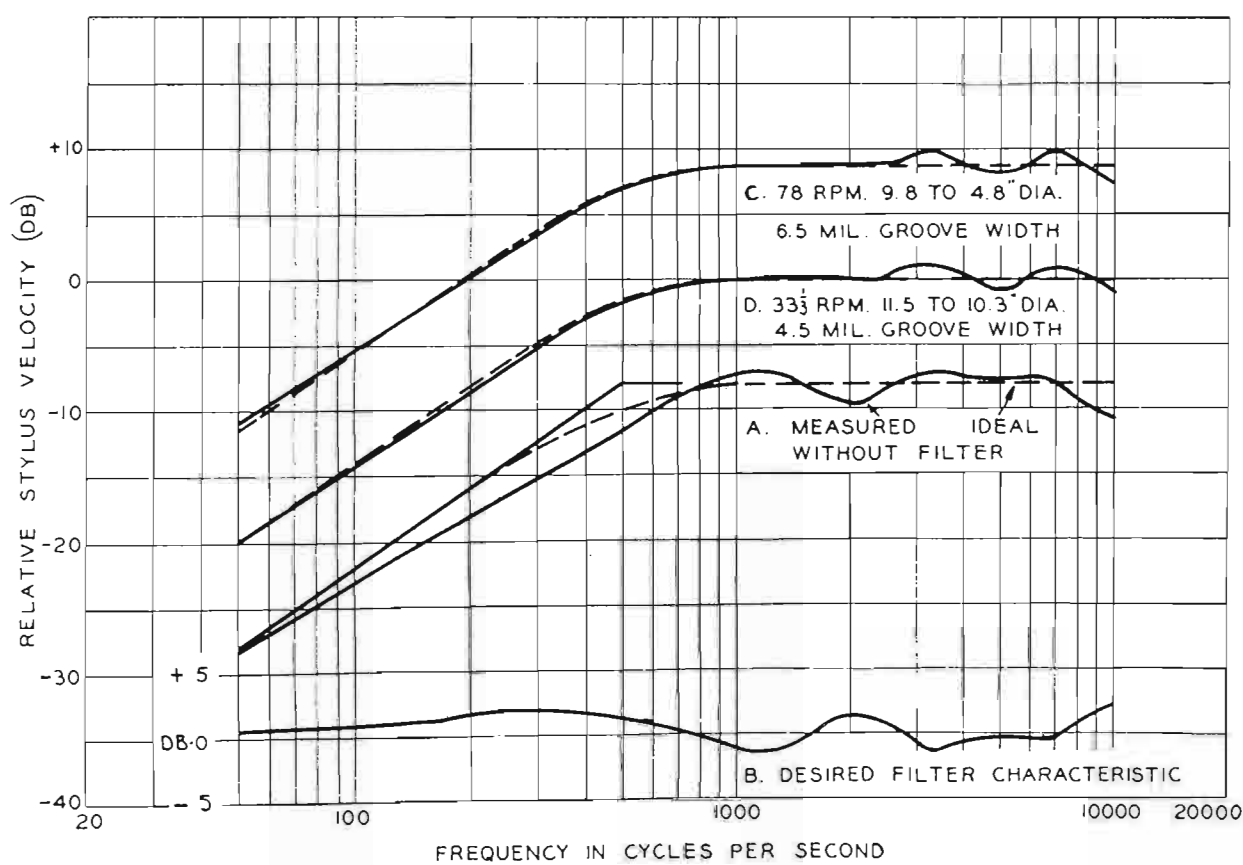

FIG. 6. Curves showing A. (cutter response without filter), B. (desired filter characteristic), C. (cutting characteristic with filter at 78 rpm) and D. (cutting characteristic at  $33\frac{1}{3}$  rpm).

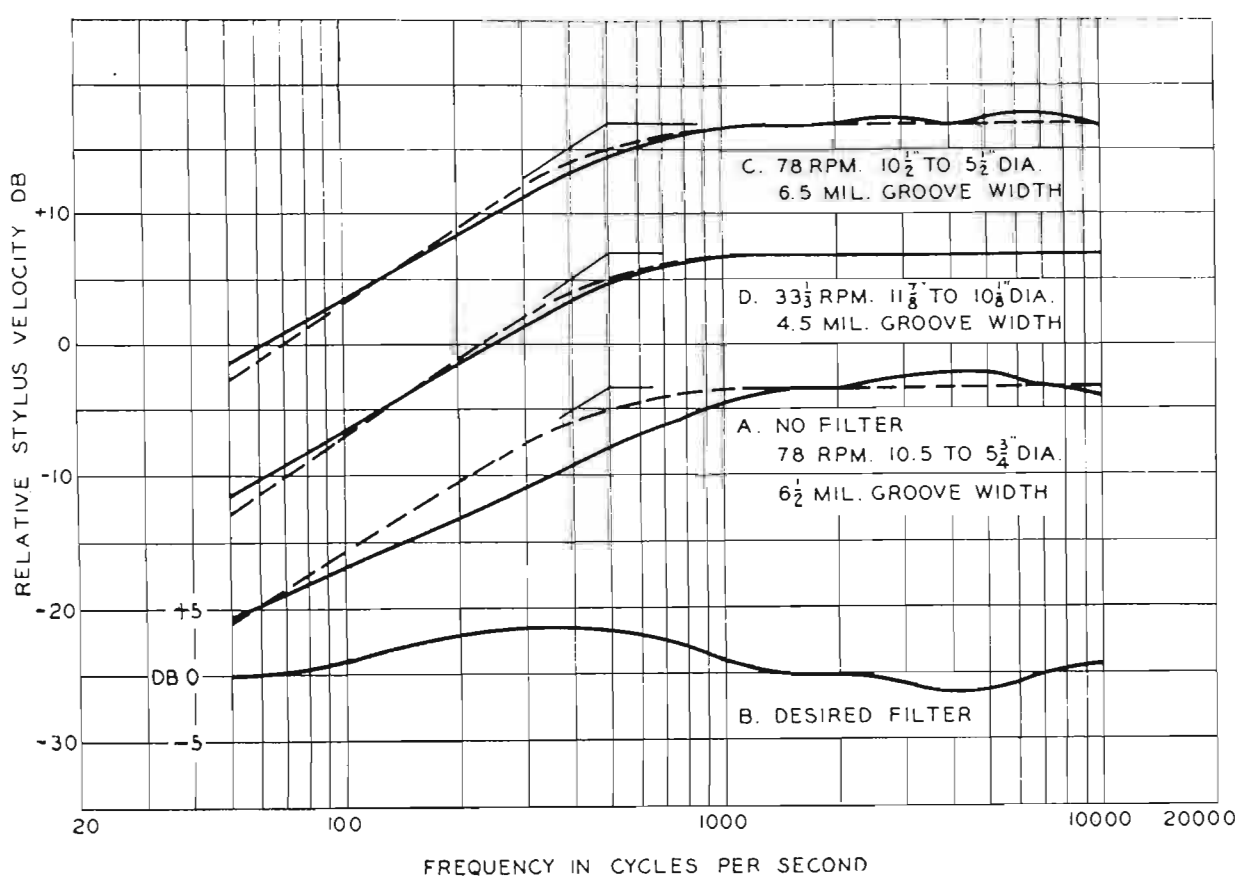

FIG. 7. Characteristics of another cutter without and with filter adjusted for proper crossover and smooth response.



over filter is not difficult. A recording characteristic is first obtained without the filter, the desired filter characteristic is derived, and the filter adjustments made with the aid of an oscillator. Cutting measurements are then taken and minor adjustments made, if necessary.

If an FM calibrator is not available, the cutting characteristic should be obtained while recording at 78 r.p.m., so that a suitable light pattern can be obtained. As is well known, the width of the reflected light pattern is constant for constant velocity of recording (3.4), so that this method may be applied for all frequencies above 1000 cycles. For frequencies below 1000 cycles, the recorded lacquer should be played back and the output readings compared with those obtained from a calibrated frequency record.

When making light-pattern measurements with the MI-11850-C recording head, it is recommended that 5000 cycles be used as the reference frequency. Measurements have shown that the variation at this frequency due to stylus loading when cutting at different diameters is a minimum. This is due to the fact that 5000 cycles lies between the two resonant frequencies which are 1000 and 10,000 cycles, so that the mechanical impedance is high at this frequency, and the stylus motion is affected very little by cutting losses. Some loss due to loading in the order of one or two db. will occur at other frequencies, such as 1000 and 10,000 cycles, and this must be remembered when cutting at different diameters. After recording a short band at 5000 cycles, some other frequency as 1000 cycles, for example, should be recorded for a few grooves adjacent to the 5000-cycle band. If the width of the two patterns is not the same, level adjustments at 1000 cycles should be made, and a few more grooves recorded for observation. As a check a new 5000-cycle band should be recorded frequently so that finally the correct level is found for 1000 cycles as judged by equal width of the two patterns which are adjacent, or nearly so. Such procedure should be followed for each test frequency from 1000 to 10,000 cycles. Precautions should be taken to have the cutter at normal operating temperature before starting, and for accuracy it is well to apply program signal during warm-up and occasionally during calibration, if much time is consumed in this process.

### Crossover at Lower Frequencies

Crossover at a lower frequency can be obtained by connecting a series capacitor and resistor across the line. By properly proportioning R and C, additional boost at the low-frequency end can be effectively obtained, and adjustments can then be made which will result in a crossover at a lower frequency. The curves of Fig. 9 show the results obtained with adjustments for 3000-cycle and also 500-cycle crossover frequencies.

### References

- <sup>1</sup> H. E. Roys: "Experience with an FM Calibrator for Disk Recording Heads." *J. Soc. Mot. Pict. Engrs.*, Vol. 44, No. 6 (June 1945), pp. 461-467. *BROADCAST NEWS*, Vol. 43, June 1946.
- <sup>2</sup> C. J. LeBel: "Properties of the Dulled Lacquer Cutting Stylus." *J. Acoust. Soc. Amer.*, Vol. 13, No. 3, Jan. 1942, pp. 265-273.
- <sup>3</sup> G. Buchman and E. Meyer: "A New Optical Method of Measurements for Phonograph Records." *Elektrische Nachrichtentech.*, Vol. 7, pp. 147-157, April 1930, translated by J. M. Cowan. *J. Acoust. Soc. Amer.*, Vol. 12, pp. 303-306, October 1940.
- <sup>4</sup> B. B. Bauer: "Measurement of Recording Characteristics by Means of Light Patterns." *J. Acoust. Soc. Amer.*, Vol. 18, No. 2, pp. 387-395, October 1946.

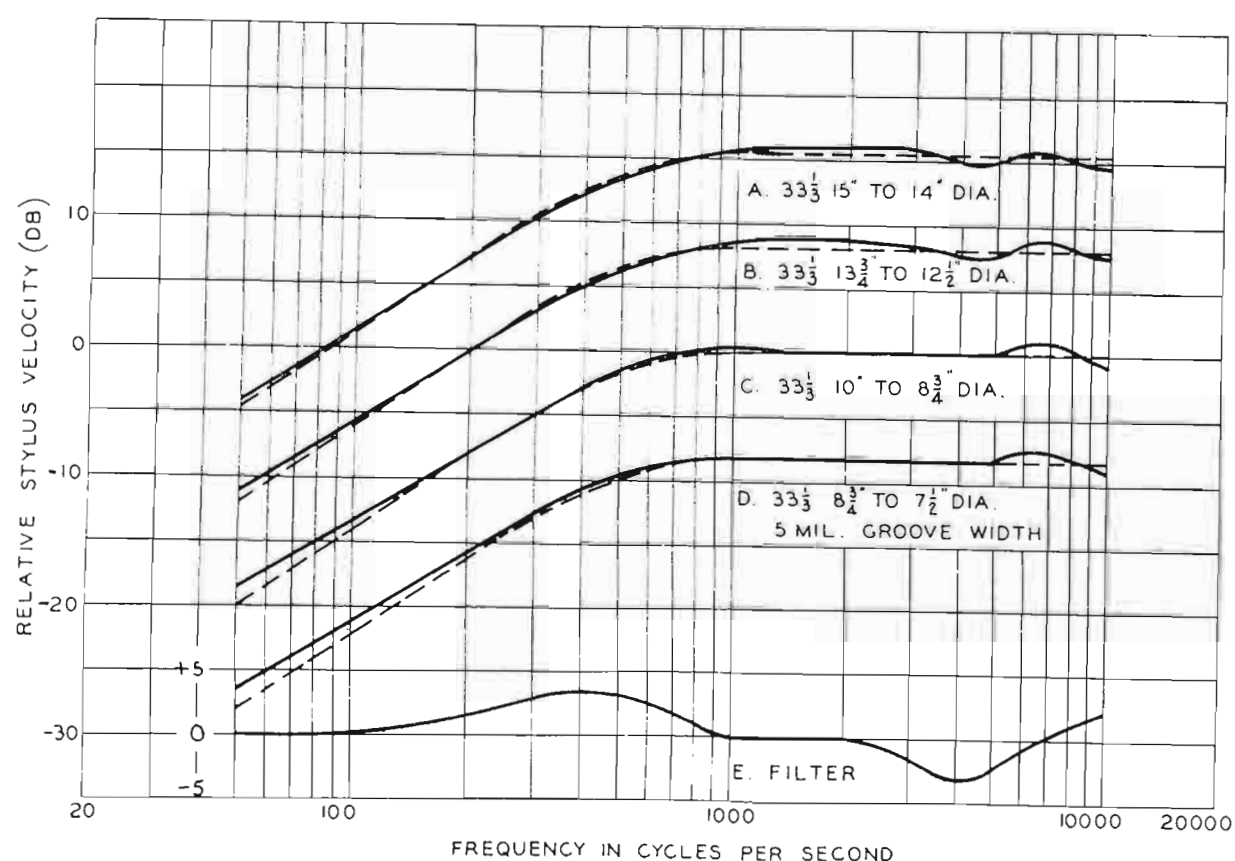

FIG. 8. Response characteristic at different recording diameters and 33 $\frac{1}{3}$  rpm. Note how little change occurs between outside and inside of the disk.

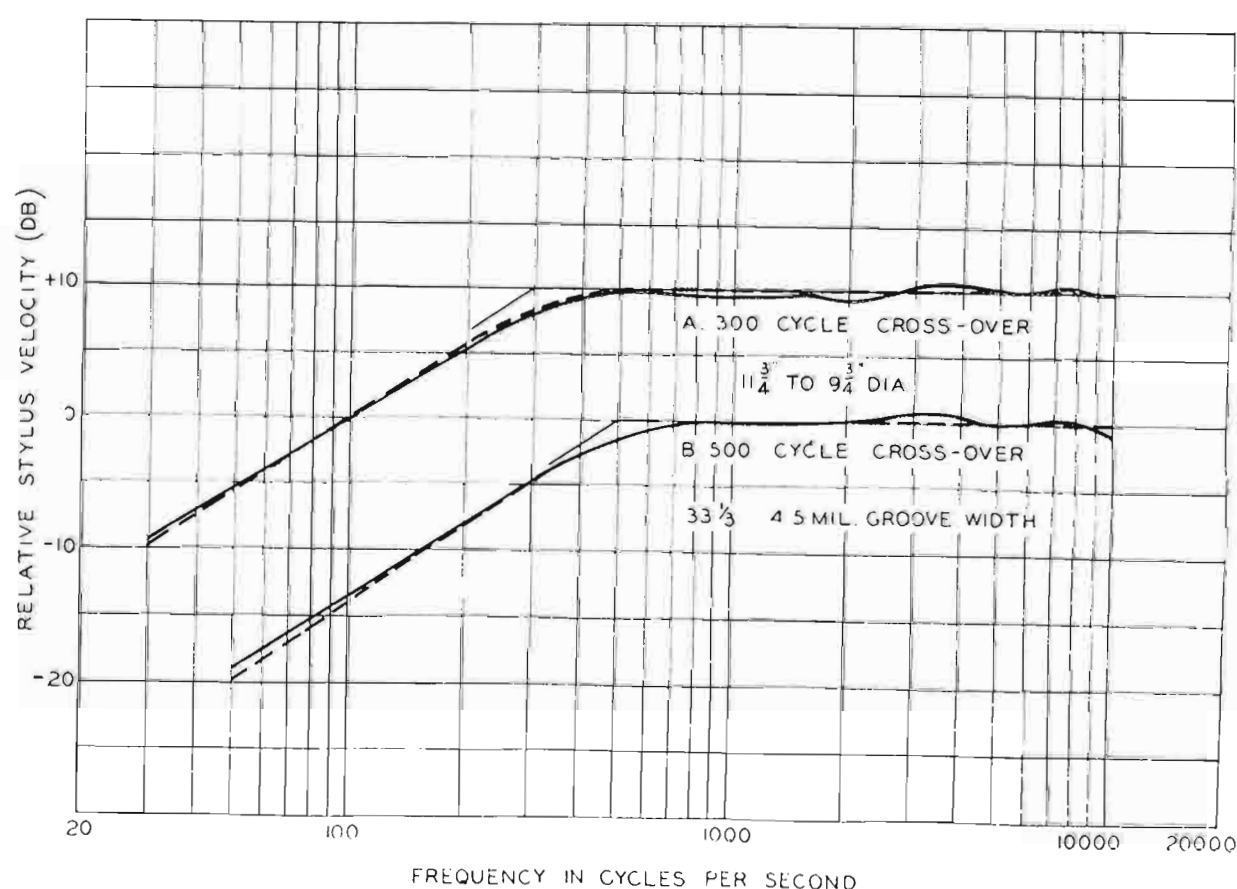

FIG. 9. Filter with additional network for 300-cycle crossover and comparison with the 500-cycle crossover adjustment.

# BROADCASTERS COMPLETE 7th RCA TV CLINIC



FIG. 1. Ease of threading tape and other features of the plug-in recorder head of the new RCA Tape Recorder, Type RT-4A, are pointed out to broadcasters by M. A. Trainer, Merchandise Manager of RCA Studio Equipment.

FIG. 3. Important features of the newly developed Program Switching Turret, which combines the functions of transmitter control and program switching in one console, were pointed out to visiting broadcasters by E. J. Meehan of RCA, (second from right).

The growth of interest in television in Canada, Latin America, and Europe was reflected in the large number of foreign broadcasters enrolled in the seventh Television Technical Training Program held at the RCA Victor plant in Camden, May 9 to 13. Fifteen foreign engineers, representing 12 organizations, were among the 87 broadcast engineers attending the clinic.

Following an opening greeting from T. A. Smith, General Sales Manager of the RCA Engineering Products Department, the broadcasters were launched on a five-day training program that included technical discussions, demonstrations, and practical experience with television broadcasting and studio equipment.

The 7th TV clinic introduced a number of new courses and demonstrations, including instruction in "Television Studio Lighting," by Capt. William C. Eddy, widely known television pioneer and technical director at Station WHEN, Syracuse, N. Y.; a discussion of "Television Propagation," by A. E. Bedford, of the RCA Laboratories at Princeton, and "Television Pickup Tube Development," by Dr. Robert Janes, of the RCA Tube Department.



FIG. 2 (above). Norman Bean (back to photographer) gave members of the television clinic very practical pointers on operation of the Image Orthicon TV camera and camera control equipment. Broadcasters were then given an opportunity to operate the various units under his guidance.



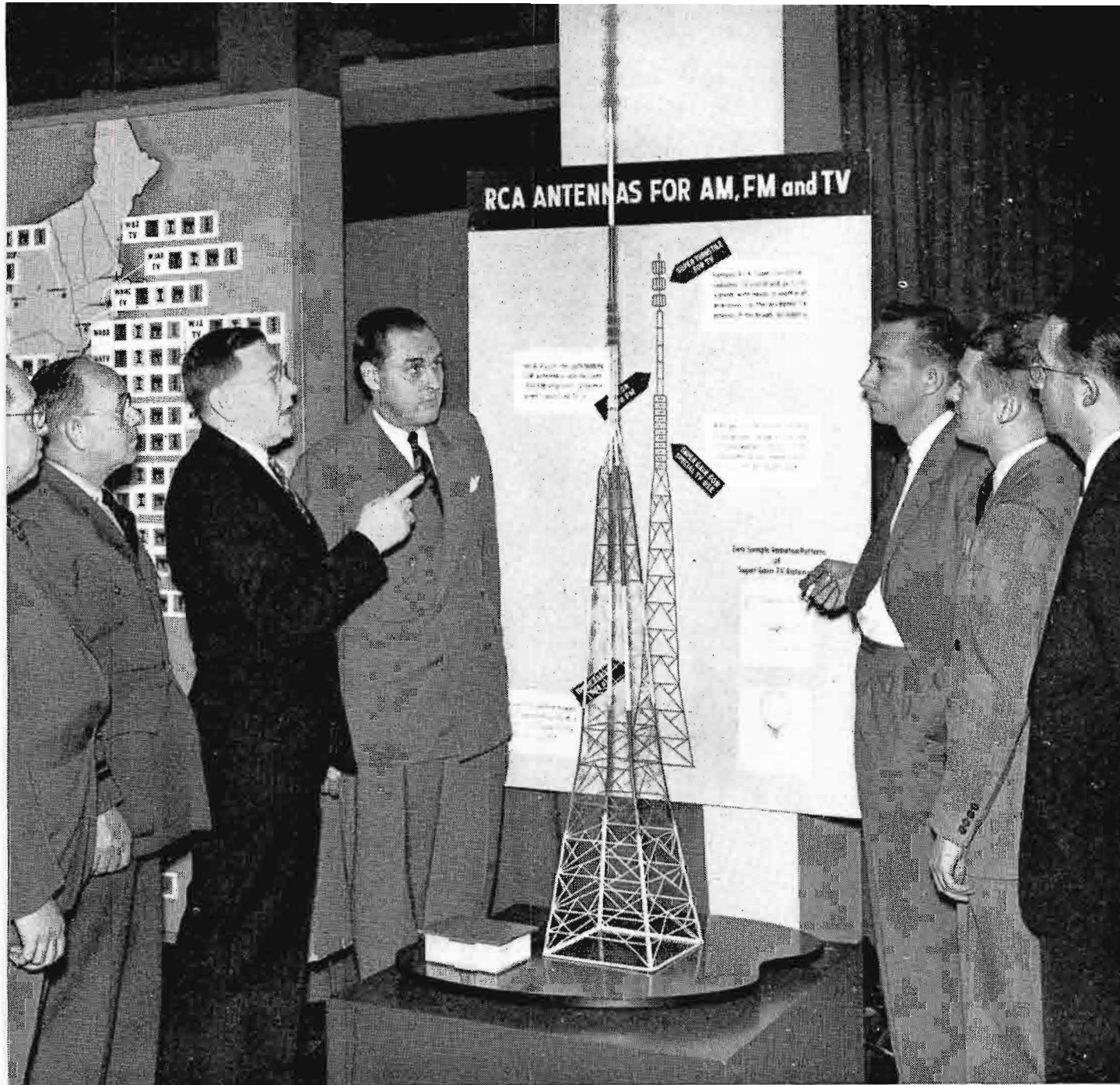

FIG. 4. The unique antenna system represented by the model shown above can perform six different services, E. S. Clammer told broadcasters. Two TV programs, three FM programs, and one AM program can be broadcast from the actual tower simultaneously. The model tower includes a Supergain antenna, a four-section Pylon, and a three-section Super-Turnstile.

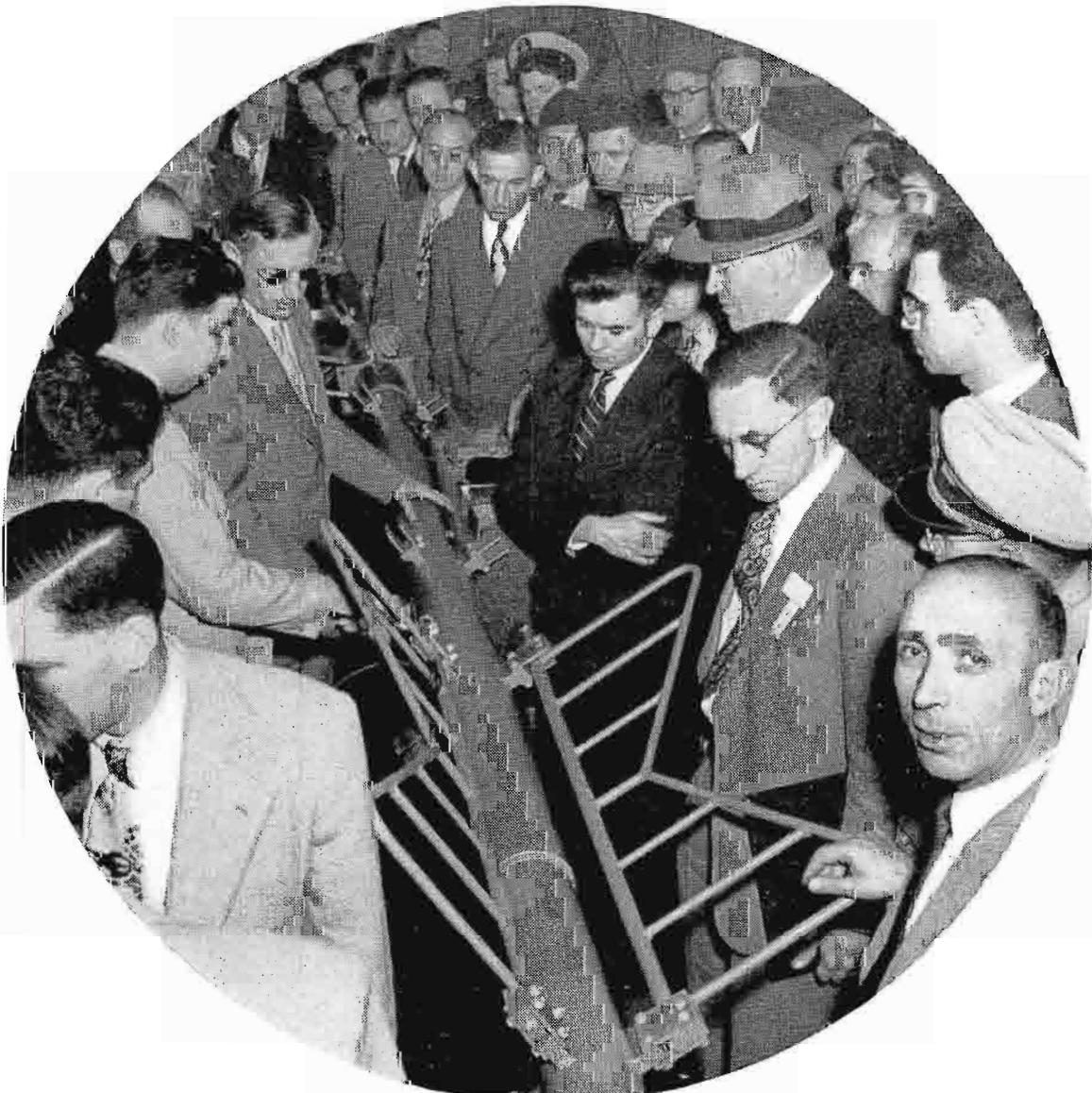

FIG. 5. While on tour of the antenna laboratory, the visiting broadcasters had a closeup view of a high-frequency Super-Turnstile antenna under construction. L. J. Wolf (wearing dark glasses) supplied all the details.

E. J. Meehan, RCA Sales Engineer, introduced equipment recently shown for the first time at the NAB convention and currently being featured by the company for use in the nation's smaller communities. He illustrated a number of flexible "secondary" station layouts that can be installed at a cost of less than one-third that of standard TV station equipment. Heart of the new, small station is a 500-watt transmitter with centralized control and switching console, facilities for film, slides, network, and monoscope camera operation, and additional facilities for adding studio and remote pickup equipment.

Those who attended the seventh television clinic included the following:

Dr. Edoardo Cristofaro and Luigi Sponzilli, Station RAI, Italy; George Brennand, of RCA, Ottawa, Canada; Walker Blake, CKUA, Edmonton, Canada; D. Readwin, CJCJ, Calgary, Canada; S. Gilbert, CFAC, Calgary, Canada; W. Obermuller, RCA, Brazil; Oistein Mittag, Radio Dept. of Elektrisk Bureau, Oslo, Norway; E. Fernandez and V. Montez, CMQ, Havana, Cuba; Antonio Zamarano, Humara y Lastra S. en C., Havana, Cuba; H. A. Audet, CBC, Montreal, Canada; H. R. Hilliard and R. Horton, CBC, Toronto, Canada; and C. I. Soucy, Canadian Aviation Electronics, Montreal, Canada; Neil Arveschoug, WDHN, New Brunswick, N. J.; Samuel Liles, WPTF, Raleigh, N. C.; G. E. Hagerty, Westinghouse Radio Stations, Washington, D. C.; K. R. Cooke, WGBI, Scranton, Pa.; H. E. Goeden, WTMJ, Milwaukee, Wis.; C. F. Fulk, WOAI, San Antonio, Texas; Carl Lee, WKZO, Kalamazoo, Mich.; E. L. Schacht, RCA International, N. Y.; John Fetzer, WKZO, Kalamazoo, Mich.; Lt. O. K. Bell, N.A.M.T.C., Pt. Magu, Calif.; J. Anlage, WFIL, Philadelphia; John Bargamian, WNAF, Providence, R. I.; Donald Patton, WAPI, Birmingham, Ala.; Norman S. Hurley, WAPI, Birmingham, Ala.; Vincent Chandler, WMUR, Manchester, N. H.; Bernard Holbert, KSAC, Manhattan, Kan.; Kenneth Peterson, WPIX, N. Y.; M. N. Kemple, N.A.M.T.C., Pt. Magu, Calif.; William H. Johnson, Jr., KYW, Philadelphia; Robert Almon, WTHI, Terre Haute, Ind.; H. R. Griffith, WJAC, Johnstown, Pa.; James Schultz, KQV, Pittsburgh, Pa.; T. G. Callahan, WBT, Charlotte, N. C.; H. G. Cole, WSBT, South Bend, Ind.; G. Pearson Ward, KTTS, Springfield, Mo.; J. Howard Bair, WCMB, Lemoyne, Pa.; C. J. Auditore, WOR, N. Y.; G. T. Brazee, WOR, N. Y.; H. L. Hadden, WOR, N. Y.; R. Marshall, WFIL, Philadelphia; Leroy Fiedler, WKBW, Buffalo, N. Y.; R. G. Artman, KMBC, Kansas City, Mo.; J. H. Keachie, RCA, Cleveland, Ohio; E. B. Vondermark, WMBR, Jacksonville, Fla.; Harlow L. Lucas, H. Nafzger, L. H. Nafzger, Bill Orr, John A. Dildine and Russell Adams of WBNS, Columbus, Ohio; and John L. Pelter, Daniel L. Falzani, George Washein, Fred Betz, Patrick Lynch, Irvin Gubin, Donald Murphy, W. H. Wagner, W. Ludes, John Early, R. F. Barry, B. L. Wolfe, Edward Carroll, Edward Harper, H. L. Higgins, W. Morris, C. Miller, David Gullette, A. W. Gengenbach, Edw. R. Johnston, S. Sabaroff, Joseph Morrow, Frank Martin, H. E. Ehrhart, B. E. Chew, E. Lewis Sturgatch, Theodore E. Vawter, from WCAU and WCAU-TV, Philadelphia, Pa.



FIG. 6. E. J. Meehan demonstrated, by use of models, the "Add-a-unit" features of RCA's Basic Buy which permits small television stations to start as simple satellite outlets for networks with film operation, and later add studio and remote equipment. Meehan is shown pointing to Program Switching Turret shown larger on page 25.



FIG. 7. In the television microwave relay laboratories, C. A. Rosencrans demonstrated the operation of a microwave relay transmitter and receiver by actual functioning units shown on the laboratory table minus the protective weatherproof cans and parabolic "dishes".

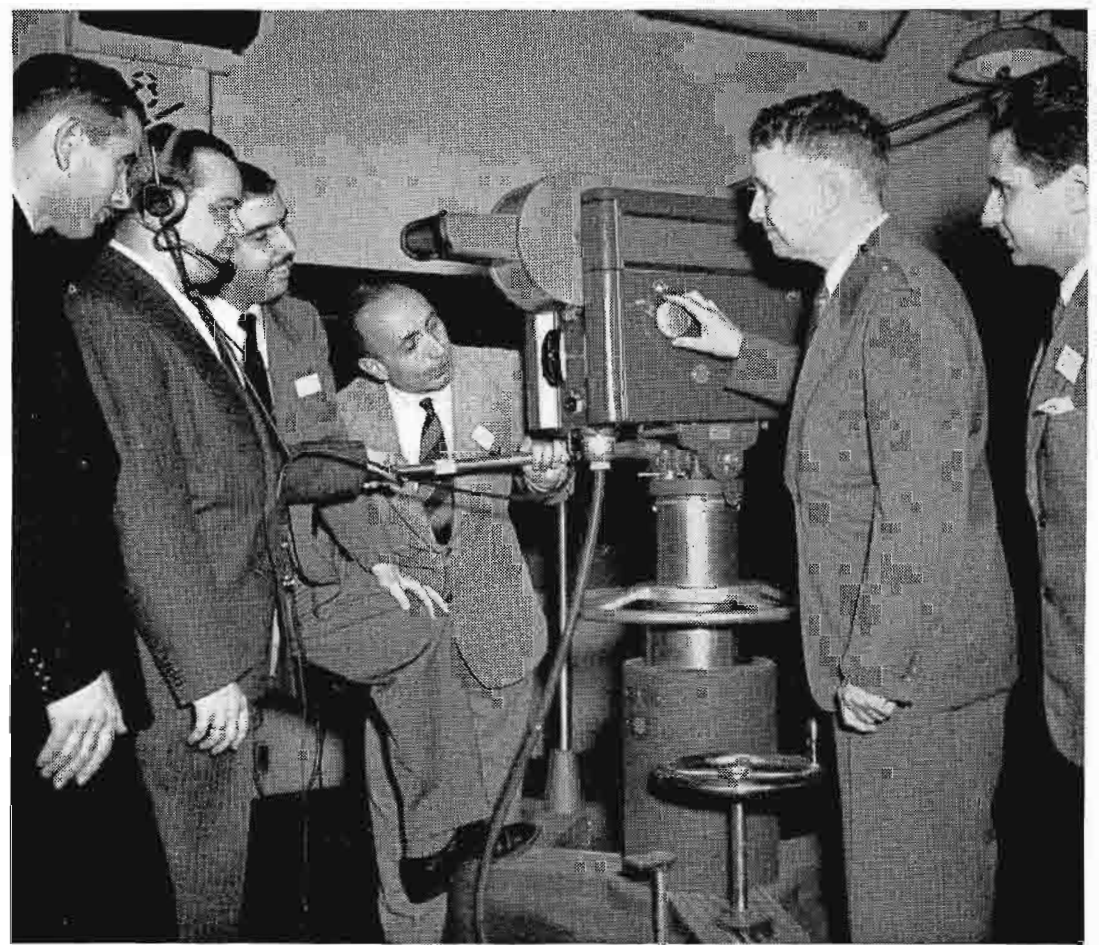

FIG. 8. Reflecting the international interest in TV, above are five of the fifteen visiting engineers from foreign countries. John H. Roe (hand on focusing knob) explains the operation of the studio television camera. From left to right, they are: W. Obermuller, RCA, Brazil; Ventura Montes, Chief Engineer of CMQ, Havana; A. Zamarano, of Humar Y Lastra, RCA Distributors in Cuba; Dr. Edoardo Cristofaro, RAI, Italy; Roe; and Luigi Sponzilli.



FIG. 1. The new mobile unit shown above, developed by the RCA International Division, carries all the technical equipment usually found in a radio studio control room. The picture shows the unit with the VHF transmitting antenna and the public address horn mounted ready for use.

# NEW CUSTOM MOBILE UNIT

by **E. L. SCHACHT**  
Broadcast Sales Section, RCA International Division

A new custom-built mobile broadcasting unit, virtually a control room on wheels, has been developed by the RCA International Division for originating programs at points remote from broadcast studios where telephone lines are unavailable or where the service is inadequate.

The mobile unit, which contains all the technical equipment usually found in a studio control room, can be "tailor-made" to the individual requirements of specific radio broadcasting stations. It is ideal for originating programs from athletic fields, reviewing stands and for covering special events from remote points.

The equipment carried in the vehicle includes the following:

A one-way VHF medium fidelity transmitter for feeding programs to the studios or directly to the transmitter building.

An RCA Type 76B-5 console for controlling program levels and for switching purposes.

An RCA Type CT-2A transmitter and Type CR-2A receiver for cue and administrative use.

A Type BN2-A remote mixer-amplifier for use in theatres or auditoriums in conjunction with the mobile unit.

A Type BTP-1A radio-microphone for use of commentators or interviewers.

A Type CR-88 communications receiver for off-the-air monitoring or for re-broadcasting.

The vehicle also contains two professional quality transcription recorders of either the disc or tape type, with which programs can be recorded for later use at the station. Mounted on the roof of the truck is a loudspeaker of the horn type for use as a public address unit. The custom-built vehicle is also furnished with all the necessary lighting, heating and ventilating equipment. It operates on self-contained

power with provision made for supplementing power requirements from regular commercial mains when available.

Equipment in the vehicle is shock mounted wherever necessary, and provision has been made to permit interchange of units in case of operation failure. For instance, the cue transmitter can be patched in to replace the program transmitter in case of difficulty with the latter unit. The public address amplifier can be substituted for the recording amplifier by merely throwing a switch.

The equipment cabinets in the vehicle provide space for a complete set of spare tubes, spare parts and tools, and specially designed compartments for holding the microphones and recording mechanisms while in transit.

Many special construction features have been incorporated in the vehicle itself. Through the use of a front wheel drive mechanism, the floor level is only sixteen inches above the road. This permits easy entrance into the vehicle and allows full standing room for the operating personnel.

For thermal and acoustic isolation, two inches of glass wool is used in the walls and ceiling. This is covered on the interior side with perforated aluminum sheet, achieving excellent acoustic qualities. The floor is covered with best quality linoleum. These measures are necessary since provision is made for broadcasting from the truck itself and to insure isolation while monitoring an outside program.

The unit shown utilizes a vehicle fourteen feet long to transport the technical equipment. Vehicles measuring seventeen feet and twenty feet are also available.

More elaborate vehicles can be furnished with such features as air conditioning, a small studio for interviews, and a gasoline-driven electric generator. If the mobile unit is to be used for educational purposes, it can be constructed to include complete 16mm sound film projection facilities.

The first of the custom-built mobile broadcasting units developed by the RCA International Division has been purchased by the Government of Turkey, for use by the Press Department. Among the uses to which the unit will be put is to broadcast concerts from a theatre in Istanbul.

The vehicle for the broadcast unit was supplied by Confield Motors of New York, distributors for the Linn Manufacturing Company.

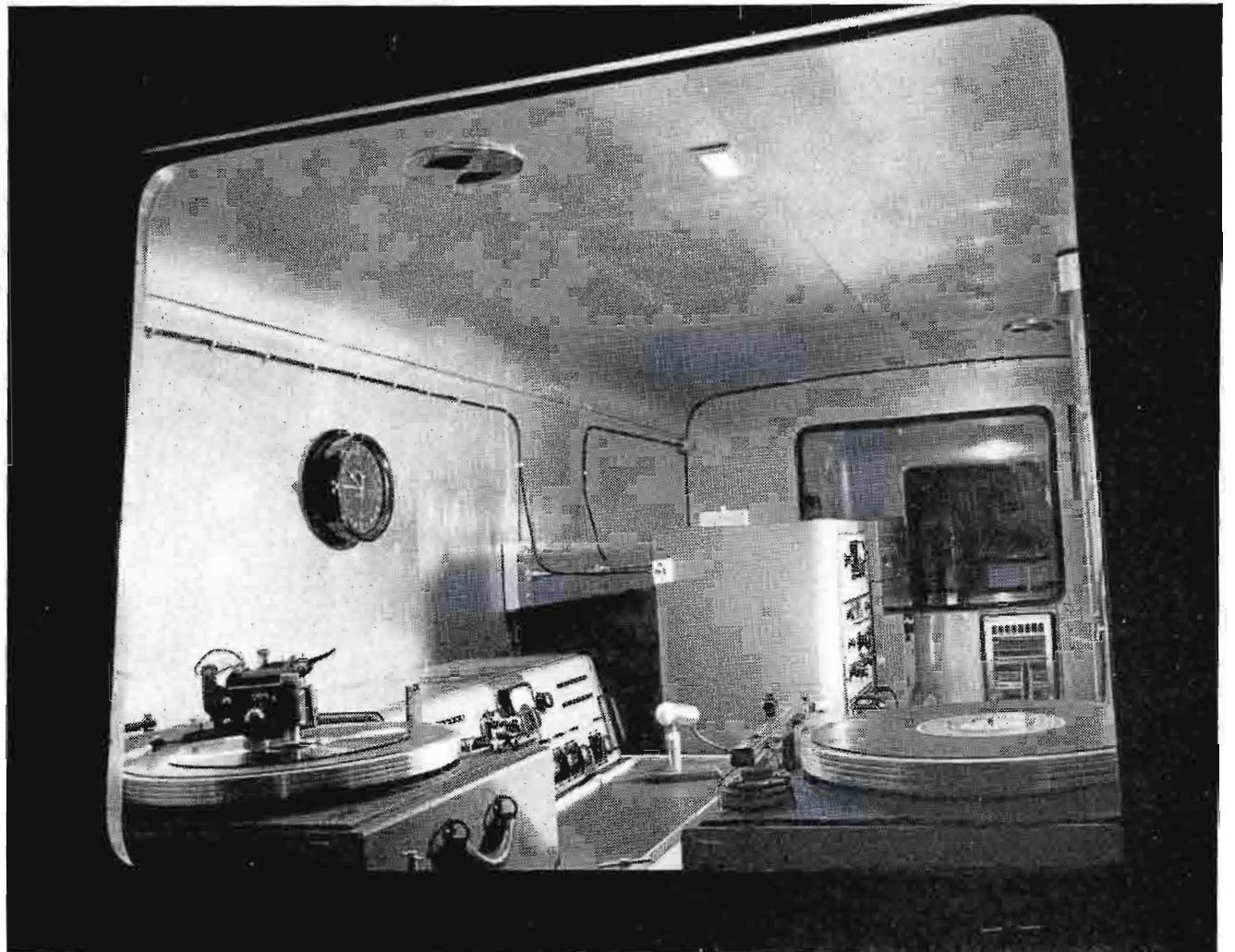

FIG. 2. This view through rear window of the mobile unit shows the location of the transcription recorders, the 76B-5 Console, and the transmitter and the monitoring racks.



FIG. 3. Another view through the rear window of the mobile unit showing the convenient arrangement of the component cabinets on the opposite side of the interior as shown in Fig. 2.



◀ WMGM Studio "F" is used for Disk-Jockey Shows, transcriptions, small shows, conferences, etc.



WMGM Studio "E" (called the "flash" studio) is used for flash news, emergency announce and interviews. ▶

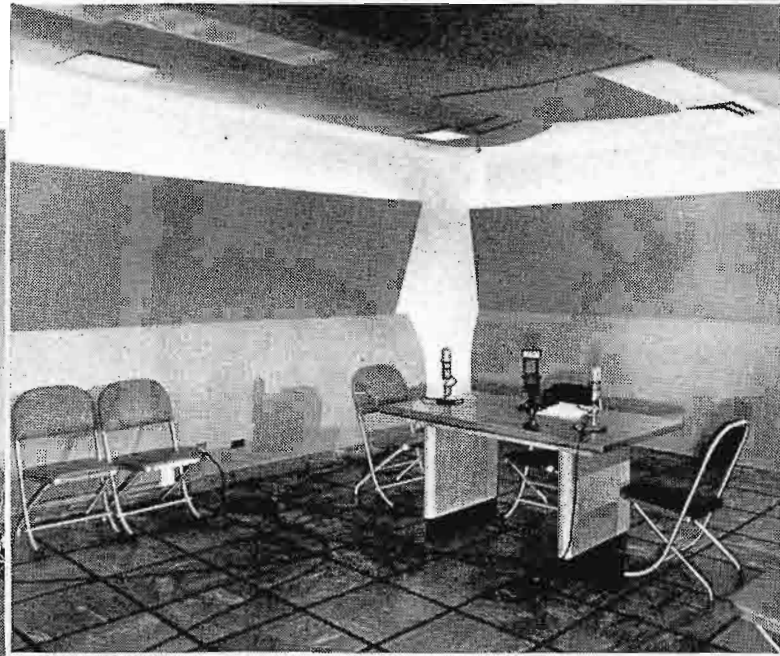

▲ WMGM Studio "A" is a large, auditorium-type studio which is used for large stage shows, studio participation, quiz programs, musicals and concerts.



▲ WMGM Studio "C" is used for announce, interviews, rehearsals and small shows.

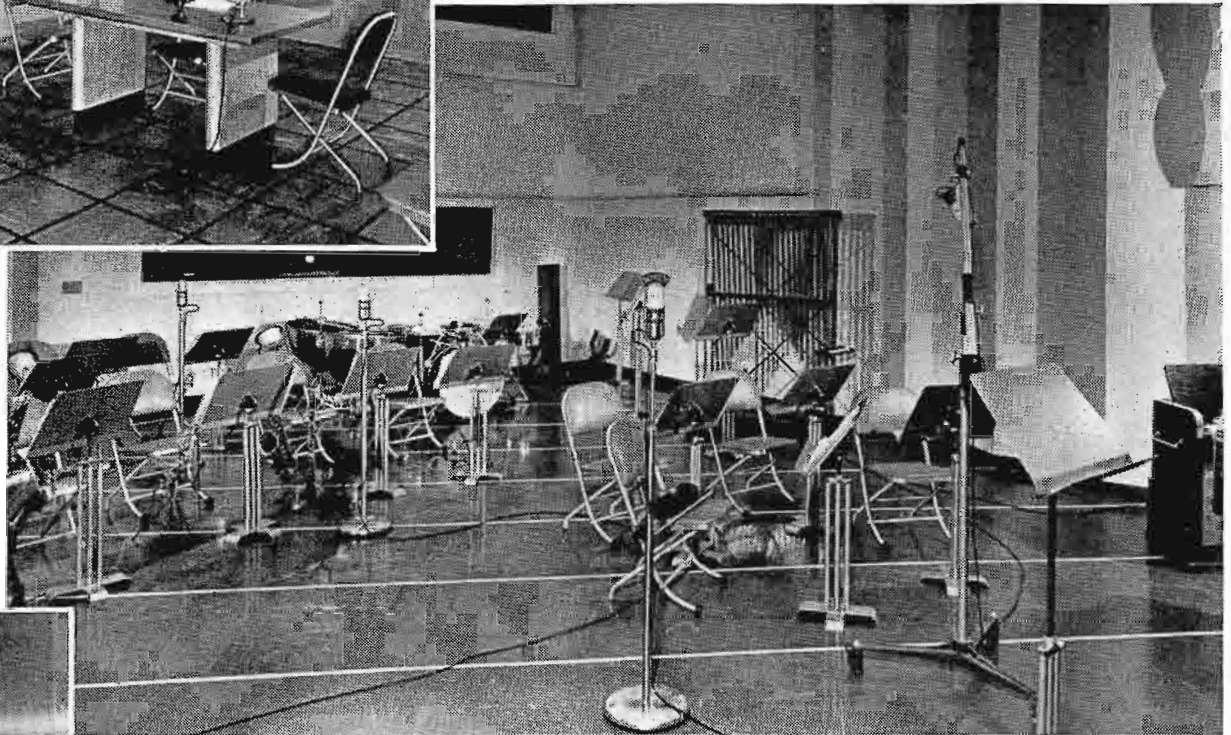

▲ WMGM Studio "D" is used for medium and small program setups, dance orchestras, smaller musicals, etc.

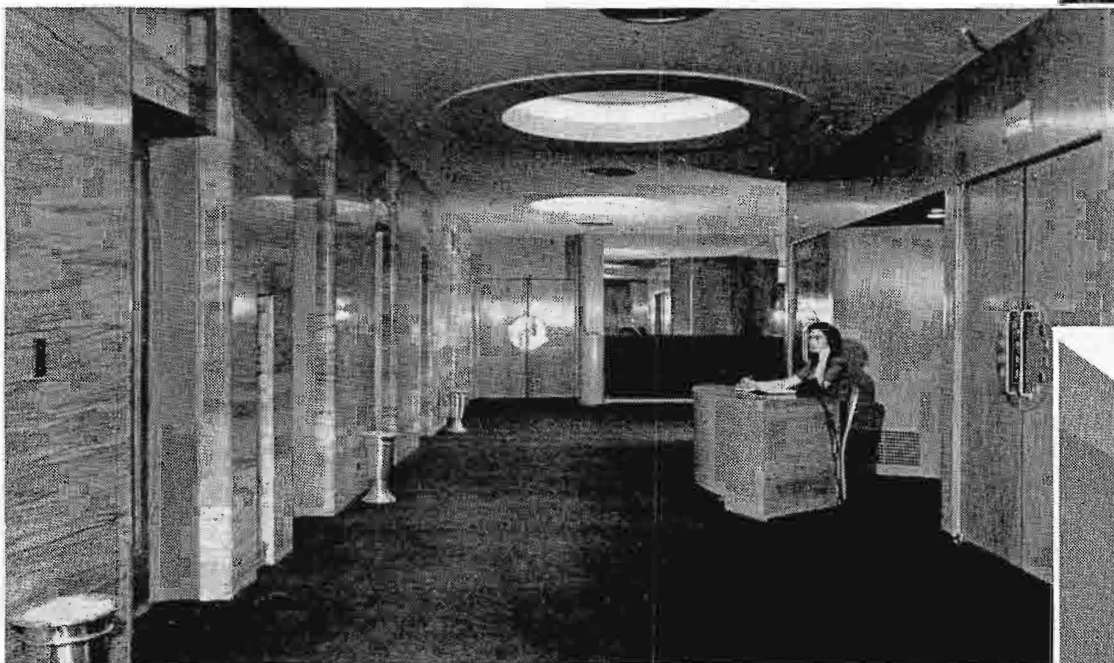

▲ WMGM's reception room for the station's ultra-modern six-studio setup.

WMGM Studio "B" is a large auditorium-type studio similar to Studio "A" for large stage shows, audience participation, musicals and rehearsals. ▶





# WMGM CUSTOM EQUIPMENT

by **M. E. GUNN**

Audio Engineering Section  
Engineering Products Department

## General Description

Although there are many services and functions performed by a master control, probably the one to be singled out as the most important would be the switching of programs (remote or studio) to one or more outgoing lines.

In addition, monitor facilities are required for offices and lobbies. Moreover, remote line terminations with associated equalizing networks are necessary, and telephone lines must be maintained for communicating to operators handling remote programs. Test gear should be available for making measurements of frequency response, noise or distortion of outgoing programs.

At WMGM, multiple output switching is accomplished by a master control pre-set system which performs all operations by means of relays. This system permits the operator to set up the succeeding dispatch-

ing circuits ahead of time. Then, during a station break interval (sometimes by the operation of a single switch) he can execute comparatively complex switching schedules in a minimum of time and without the chance for error that would exist if each studio had to be switched independently. This system is flexible in that channels can also be operated individually if it is necessary to switch a channel at some time other than a quarter-hour interval when most program changes are made. With the improved performance obtained, and considering that there is less likelihood for operating error, then installation of this type of pre-set system is a sound investment.

At the present time there are six studios in operation at WMGM (see montage page opposite) and these as well as three remote program circuits can be switched to one or all of six outgoing channels. In addition, there is one spare program input which may be used as an emergency input or may be reserved for future expansion of studio facilities.

## Master Control

In the WMGM installation all of the master control equipment (see Fig. 1 below), including preset switching controls, is mounted in RCA standard cabinet racks. The switching system is composed of six identical sets of controls, relays, and lights (one set for each output channel). All of this equipment is mounted in three racks which are bolted together to form a single unit. This forms a center section which is placed 6 inches back of a main rack line up consisting of six racks on each side. The 6 inch offset provides extra under-the-counter leg room. This counter, which is approximately 13 feet long, provides working space and gives all the operating conveniences of a desk-type control system. The counter top is covered with burn proof micarta and the edge is trimmed with aluminum mounding 4 inches wide. The counter assembly is fastened securely to the racks by means of heavy angles, thus making it unnecessary to have any legs for support. Cutouts in the counter edge serve as convenient locations for telephones.

FIG. 1. The WMGM Master Control Console includes 12 deluxe audio equipment racks (six on each side of the master center section). Designed for AM, FM and TV, the console provides control of 10 studio inputs and feeds 6 channels simultaneously, or individually by a preset relay system.

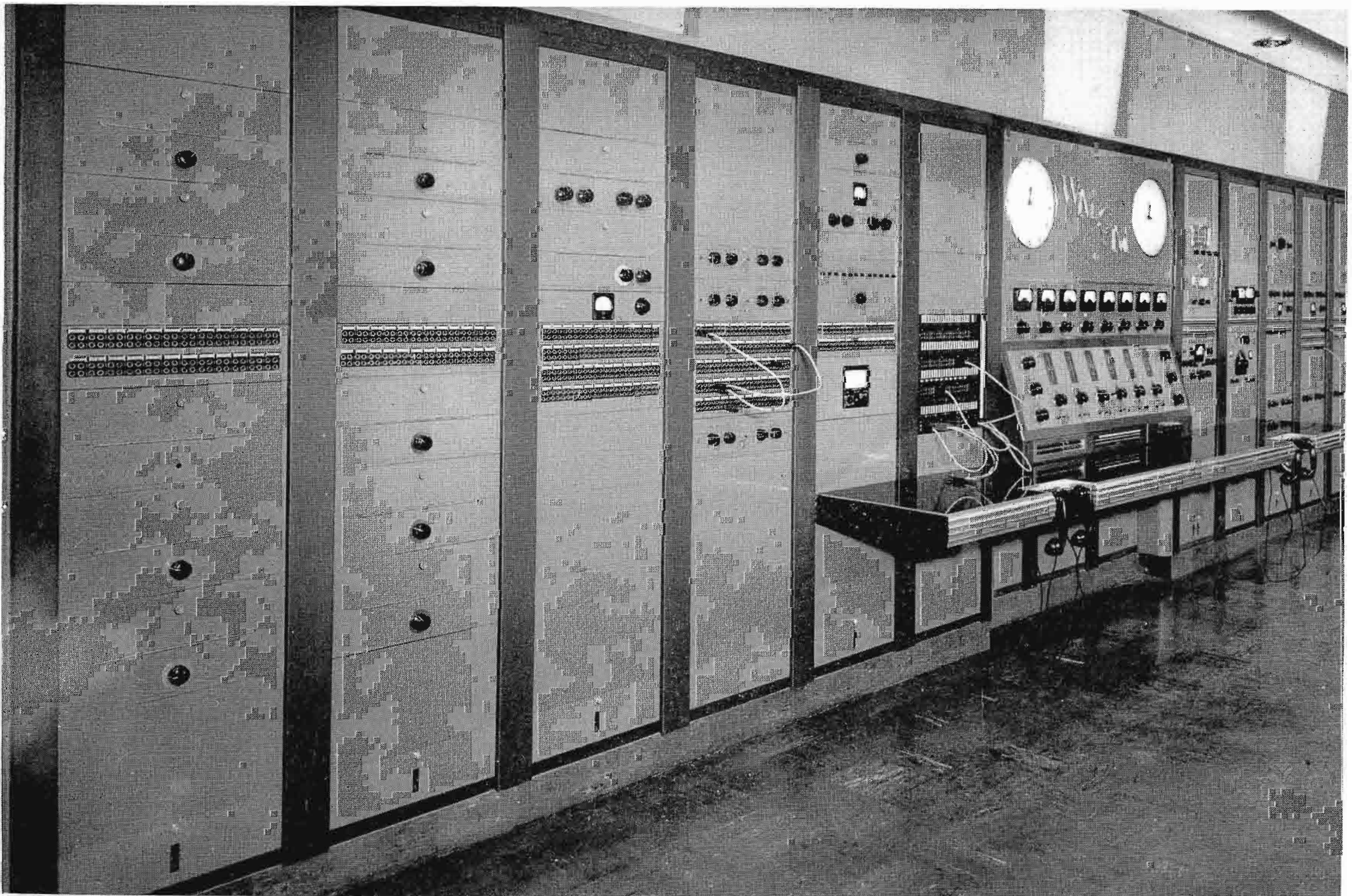

Although the center section is set back 6 inches from the rest of the racks, the area above the counter which contains meters and clocks is built flush with the rest of the racks in order to present a uniform appearance. Pre-set switching controls and supervisory light banks are mounted on a sloping turret which extends slightly forward from the rest of the equipment.

All master control racks are mounted flush with the wall. Thus, space at the top ends is closed off and a door is provided at the left-hand end, leading to the area in back of the racks. Three LC-1A monitor speakers are built into the wall above the racks and are splayed to a degree to give optimum listening advantage. Although this installation was made in a room having a concrete floor, what might have been a problem of running conduits and cable troughs to the various racks was easily solved. RCA cabinet racks have a 4-inch base which is removable. These bases were removed and the racks mounted on two 5-inch steel channels which were laid on top of the existing floor. These channels extend across the room in a continuous line (with a 6-inch offset for the center section). A false floor of wood is laid flush with the top of the 5-inch channels in back of the racks. Space under this is adequate for all the required conduits and cable troughs.

## DESCRIPTION OF EQUIPMENT AND FACILITIES

### Output Channel Switching

As mentioned previously there are ten inputs to the relay switching system with a possibility of feeding six output channels. The 600 ohm incoming circuits are converted by means of a transformer to an impedance of 150 ohms for switching, and are terminated by a 150 ohm resistor. This termination is necessary, since all output channels are bridging and several (up to six) channels may take the same program. Each of the six output channels consists of a bridging transformer, a master gain control, a BA-3C line amplifier, and a dividing network which feeds the regular line and a monitor circuit. A VU meter which is also fed from the dividing network indicates the signal level to the line.

Each monitor circuit contains a BA-1A amplifier with a bridging volume control input. This provides the necessary isolation to prevent any line disturbances in the monitor system from getting out on the regular program channel. In addition to the six regular output channels there are six emergency circuits each consisting of a bridging transformer and a BA-3C amplifier. Both ends of these circuits are terminated on jacks, thus providing complete stand-in protection for all channels in case of any emergency.

### Remote Pickup Circuits

The handling of incoming remote programs involves two considerations. One is to maintain communication with announcers or operators at remote locations which is done with a talking circuit usually referred to as an "order wire". The other consideration is to receive the incoming remote on a line separate from the order wire—equalize it, if necessary, and route it either direct to the master control switching system, or to a studio (depending on how the schedule is set up).

WMGM has 60 incoming remote lines, 30 of which have individual RCA type 56-C equalizers. Three type BE-1B variable equalizers are supplied to correct the characteristics of lines other than those which are permanently

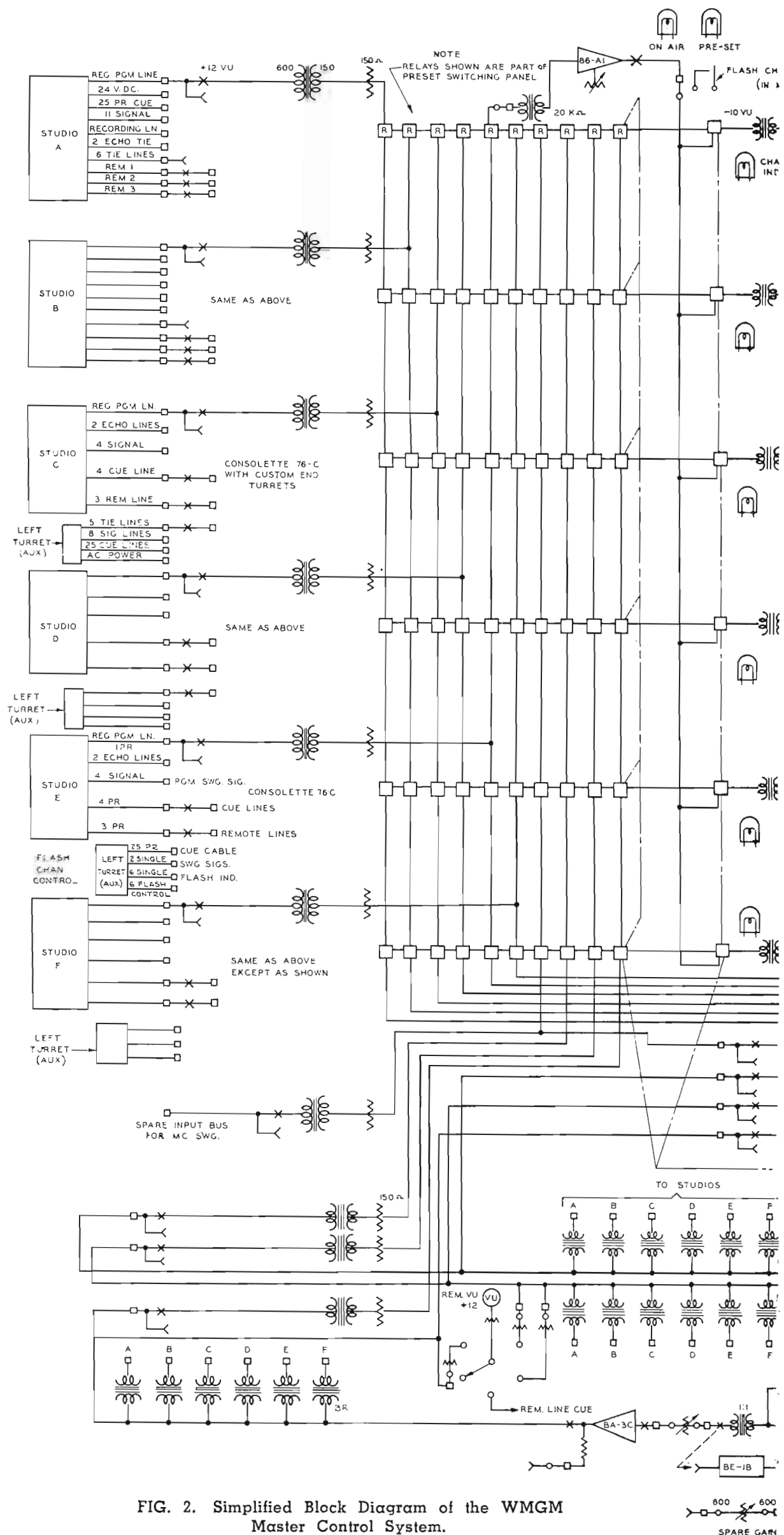
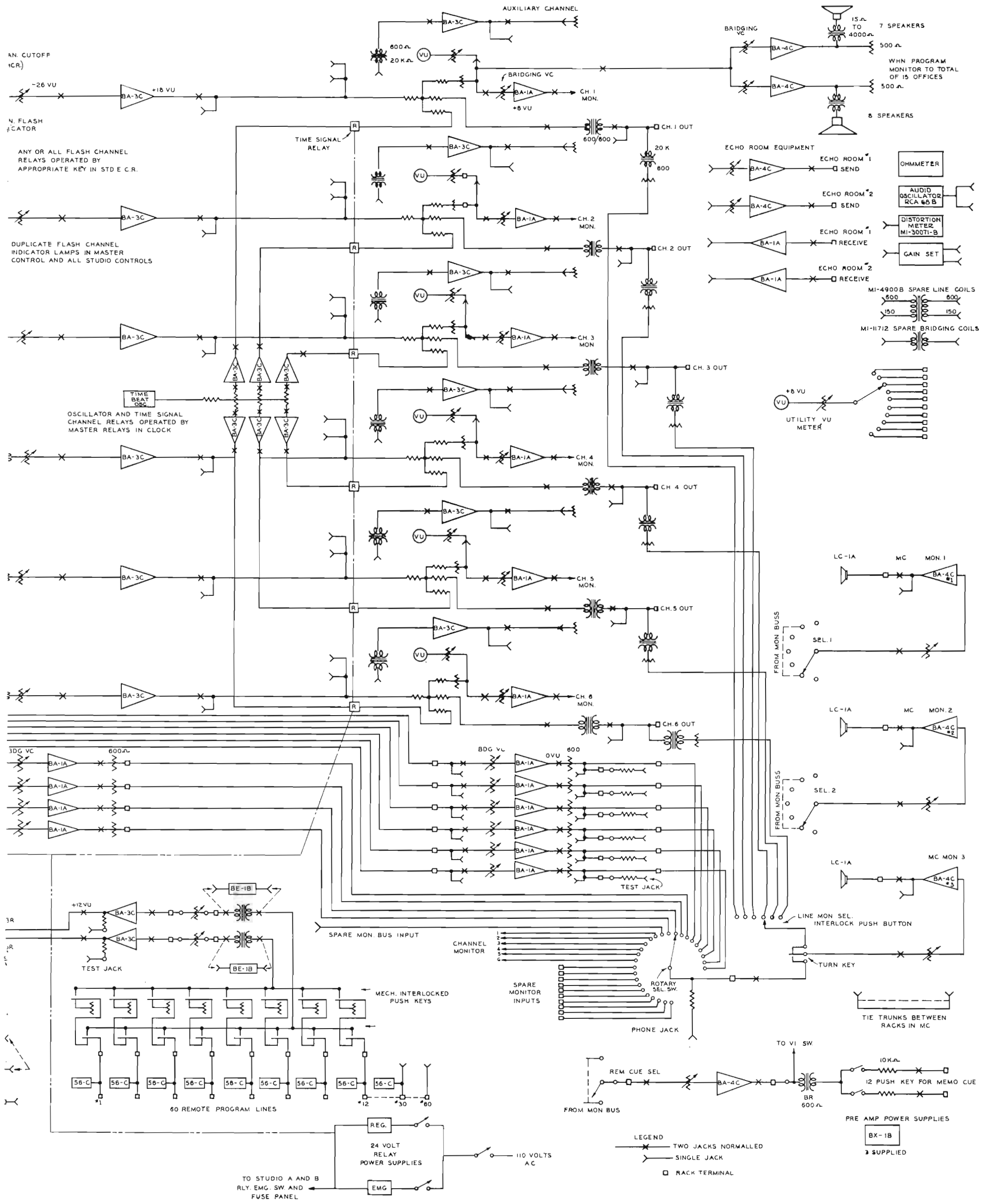

FIG. 2. Simplified Block Diagram of the WMGM Master Control System.



equalized. Twelve of the lines are permanently normalled to two banks of mechanically interlocked push keys. The common output of each bank of push keys feeds a separate remote amplifier circuit which enables the signal to be adjusted to the proper level for feeding the switching system. The input to a third remote circuit is not connected to any switching device, but is terminated on jacks. Bridging transformers feed the remotes to all studios so that they may be handled in conjunction with a regular studio program. In addition, it is impossible to select the same incoming program on both switches at the same time. This requirement which is necessary in order to maintain the proper load impedance and preclude the possibility of a mismatch to the line is accomplished by having one set of switches wired in series with the other.

An amplifier circuit using a BA-4C is provided to feed cue to the remotes. By means of a selector switch any one of the monitor buses may be fed to this remote cue amplifier.

#### Monitor System

There are 3 monitoring circuits each consisting of a BA-4C amplifier and an RCA LC-1A High Fidelity speaker. Input selectors to these amplifiers are connected to a monitor bus system consisting of 16 circuits with isolation amplifiers. Monitor-

ing points available are the ten switching inputs and the six outgoing channels. To provide an additional check on the overall channel circuits, a bridging transformer is connected to the terminals where each channel output terminates in the rack. These six outputs appear on a six-position mechanically interlocked push-button switch. The output of this push-button selector can be switched to the input of one of the monitor amplifiers to provide a final program check. Jacks are also available to provide means for additional checking and monitoring.

#### Other Features

A beat frequency oscillator feeding six BA-3C amplifiers provides tone signals which can override any regular program or announcement on each of the six input channels. Relays operated by the master clock provide "on-the-hour" tone beats.

Another feature at WMGM is the fact that one of the studios (Studio "E", can interrupt the regular program on one or all of the output channels and feed those channels directly with a special announcement. This by-passes the pre-set selector system and normal operation is not restored until control is released by Studio "E". There is, however, a cutoff switch in the master control room which can take this control away from the studio. To preclude the possibility of unwarranted pro-

gram interruption through misuse of the Studio "E" channel operate keys, power to operate the override relays is not fed to the studio except by orders of station management. Lights in all studio control rooms as well as master control indicate when any channel is interrupted by Studio "E".

Amplifying equipment for two echo rooms is supplied. Each equipment consists of a BA-4C echo speaker amplifier, and a BA-1A echo microphone pre-amplifier. Tie trunks make it possible to connect the echo circuits to any desired studio.

Two BA-4C amplifiers are bridged across output channel No. 1 and are used for feeding speakers in 15 offices.

Ample test equipment is supplied to provide the station with all the necessary facilities for measuring frequency response, noise and distortion of any program circuit. Tie lines to the various studios make it possible to pipe studio circuits to master control to also utilize this equipment. Spare line and bridging coils, as well as fixed pads of various losses, are provided and can be used as an aid in making measurements.

#### WMGM STUDIO EQUIPMENT

##### Studio "A"—Constructional Features of Control Console

A deluxe studio desk (see Figs. 6 and 7) was designed to provide in a single unit

FIG. 3. Closeup of a section of the Master Control audio racks showing how all amplifiers, individual controls and components are easily reached. Plug-in type amplifiers are used throughout.

FIG. 4. Rear view of three Master Control audio equipment racks with doors removed to show neat mechanical design and orderly arrangement of parts. Note how all wiring is carefully "dressed" and brought out to terminal strips.



all operating facilities for the control of Studio "A", which is one of two auditorium type studios in the WMGM operations. It was intended that this studio console should offer the maximum in fidelity, flexibility, reliability and operating convenience. Appearance was also to be of utmost importance considering the prestige of the station.

The desk is constructed entirely of steel and completely replaces conventional rack equipment with its associated console, by providing a housing for all the amplifiers, power supplies, relays, etc. These components are mounted and housed in two pedestals which in a conventional type of desk would be reserved for drawer space. Each pedestal has a 2 inch x 6 inch opening in the back which is connected to an air conditioning duct in the wall. This provides enough cool air to prevent abnormal temperature rise due to heat from the amplifiers. An air filter is placed over the duct opening to preclude the possibility of any dirt entering the pedestal from the ducts. The overall dimensions of this console are: length 68½ inches, depth 35 inches and height 39 inches. With this low overall height, there is no obstruction of vision into the studio.

Each of the pedestals has three compartments. Doors to these compartments are flush fitted and each is supported by a continuous piano hinge. The doors are latched by bullet-type catches which assure ease in opening and closing. In the left pedestal there is one large compartment with a door opening to the inside of the desk. There are three shelves in this compartment on which are mounted eleven pre-amplifiers, RCA type BA-1A, two power supplies RCA type BX-1C and several line and bridging transformers. Amplifiers and power supplies are of the plug-in type, therefore, the removal of these units for any reason is a simple matter.

Another smaller compartment, opening to the inside, contains two circuit breakers and pilot lights, a switch for emergency relay voltage and a meter for checking the cathode bias voltages of BA-1A and BA-3A amplifier tubes. Two selector switches pick up the metering terminals of these amplifiers.

The third compartment which opens to the front, contains terminal blocks for connecting to external AC power circuits as well as incoming microphone lines. A fuse board with alarm type fuses for DC circuits is also located in this compartment. The placement of terminal blocks in this convenient location facilitates trouble shooting when it is necessary to check

external circuits to the desk. Needless to say, the desk installation was less of a problem than with the terminal blocks in some out of the way place.

As previously mentioned, the right pedestal also has three compartments. The large compartment has three shelves containing six type BA-1A as booster amplifiers, two type BA-3C program amplifiers (one regular and one emergency), one BX-1C power supply, and a type BA-4C studio monitor amplifier.

A second compartment contains a small

jack field for all speaker circuits. Since these are high level circuits, this location affords the isolation desired and keeps all loudspeaker jacks out of the main jack field. The studio speaker volume control which is in the voice coil circuit is also located in this compartment for the same reason. The balance of space is used for the storage of patch cords when they are not in use.

The third compartment, opening to the front, contains audio terminal blocks and speaker relays as well as a volume control

FIG. 5 (at right). Herbert L. Pettey, director of Station WMGM, with Deborah Kerr, MGM star, inspects the studio "B" control console.



FIG. 6 (below). This custom-built studio console provides complete facilities and operating convenience for the control of auditorium type studio "A". Identical equipment is also employed in large studio "B".

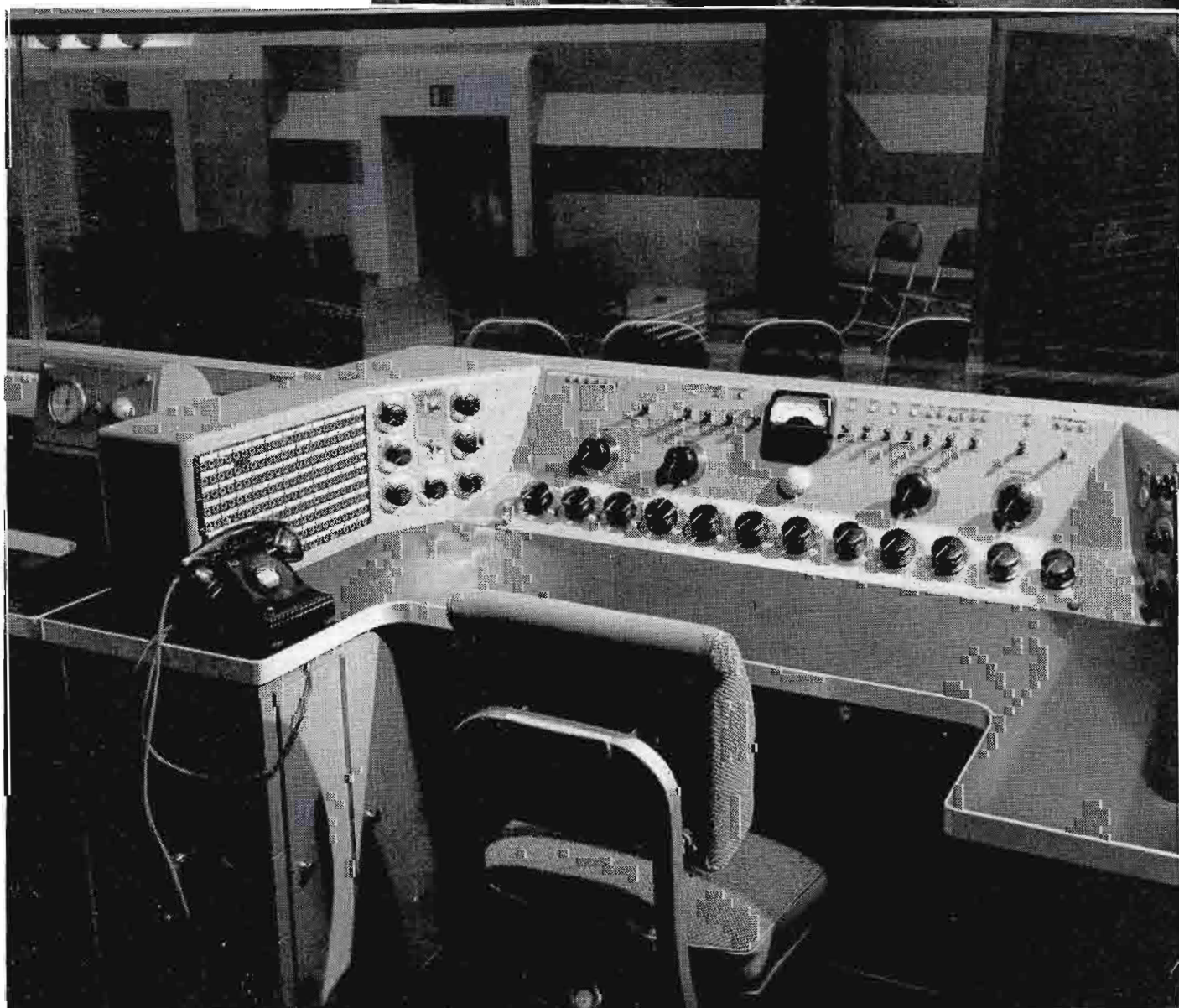

for studio headphones. The terminal blocks are placed so that external wiring connections to them are easily made. Conduits which carry wiring to the terminal blocks come up into the terminal block compartments and are stubbed about two inches above the floor.

The sides or ends of the desk pedestals which are fastened with concealed screws were removed during the time the desk was being wired to provide easy accessibility to all amplifier plug terminals.

There is a continuous turret built on the desk top and this extends from the left of the operator around to his right. Since the height of this turret is only 39 inches above the floor, adequate visibility into the studio is enjoyed by the control operator while seated at the desk.

The most essential controls, such as mixers, key switches, VU meter, etc., are mounted on a panel directly in front of the operator. This panel is hinged at the top so that it can be raised for obtaining access to any parts that may require maintenance. There are two slopes to this control panel, to provide maximum operating convenience.

The mixer controls are mounted at a 60 degree angle (from the vertical plane)

which permits long periods of operation with maximum comfort and minimum fatigue even though these controls usually require continuous readjustment during programming.

The part of the panel containing switches, master gain controls and the VU meter is on a 15 degree slope. This places the meter in a position to give maximum advantage to the operator. A talkback microphone for use during rehearsals is panel mounted and located directly under the VU meter.

There is a jack bay on each side of the control operator, each bay containing 99 pairs of jacks. Access to jack wiring is gained by removing a panel in the back of the turret. Each jack bay turret is joined to the center panel turret thus providing enclosed space for mounting additional equipment, such as PA volume controls, echo mixers, sound effects controls, etc. These controls require only occasional adjustment, so they need not be part of the main panel. However, the panel on which they are located is arranged at an angle which provides maximum convenience to the operator when their usage is necessary. Access to each of these two side compartments is by a hinged lid which is flush mounted in the top.

### Studio "A" Producers Desk

An added feature of this studio control equipment is a producers desk (see Fig. 8) which is styled like the control desk except it has no overall control turret. The left end of the desk has a pedestal exactly the same as the pedestals on the main console. The right end fastens to the main console so that it becomes part of it. In the left pedestal are mounted two auditorium PA speaker amplifiers, type BA-4C, and one clients speaker amplifier, also a type BA-4C. This compartment also has connections to an air conditioning duct.

The producer's controls consist of a studio talkback microphone with associated operate switch and an interval timer used principally for timing shows during rehearsals. These producer's controls are mounted in a small turret placed on the desk.

### Studio "A"—Program Control Facilities

All of the mixing, amplifying, monitoring and special effect facilities required to produce and control a program of the utmost complexity are contained within the control console.

A twelve position mixer which permits the simultaneous mixing of ten studio microphones and two incoming remote lines is incorporated in the design.

The first six mixer circuits are controlled by one program key and each of the other six mixers has an individual key for cutting the circuit in or out.

This feature is especially advantageous for the control of large programs using an orchestra with a multiple microphone pickup. It is possible to cut in single microphones for announcers or vocalists while fading the entire orchestra down with a single control.

Each bank of six mixers feed into a separate booster and master gain control. The outputs of these gain controls are combined by a matching network to feed a single channel into a BA-3C amplifier. An extra channel consisting of a BA-1A booster, a master gain control and a BA-3C amplifier is available for emergency service. A key is provided to feed either channel to master control.

A three-position echo mixer circuit with bridging transformer inputs and a BA-1A booster is supplied. Reverberation characteristics may be applied to as many as three microphone channels by patching from a pre-amp output multiple to one of the bridging transformer inputs. The BA-4C for feeding this signal to the speaker in the echo chamber is located in master control. The echo microphone pre-amplifier which is also in master control

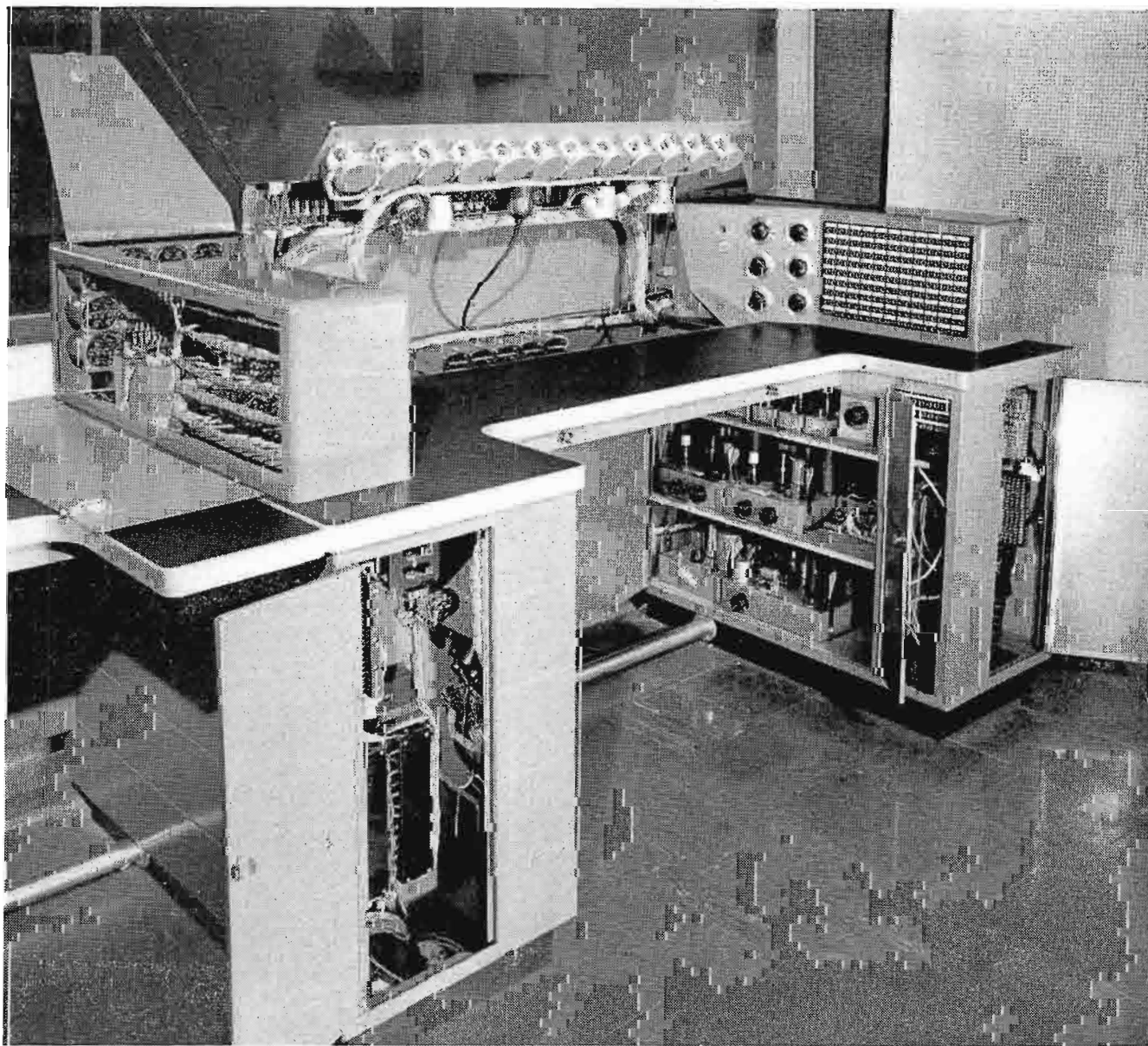

FIG. 7. Design of the studio "A" and "B" control consoles includes every feature needed for operating ease and convenience. The hinged sloping front panel, compartment side panels and doors provide complete accessibility.

feeds the signal back to the studio on a tie line. As this circuit is 600 ohms, it must be patched into an unused mixer position to be combined with the normal program. Two sound effects filters are supplied to obtain a wide variety of effects in conjunction with the reverberation facilities.

Another three-position mixer circuit with bridging inputs is provided to reinforce certain microphones for the benefit of the studio audience. Microphone reinforcement is often desired and sometimes requested by certain radio artists as well.

The output of this mixer system and associated booster amplifier feeds two BA-4C amplifiers, each driving an LC-1A speaker concealed in the proscenium. Gain of the PA amplifiers may be controlled by a person in the back of the auditorium thereby assuring the proper speaker level for any size audience and at the same time preventing acoustical feedback. Usually it is necessary only to reinforce dialogue, sound effects, vocalists, announcers or special features and not an entire orchestra playing on the stage.

There are three input possibilities to the BA-4C monitor amplifier which feeds the control room speaker and a studio speaker. The input to the BA-4C amplifier is normally connected to a dividing network in the output of the program amplifier as a regular monitor. A key transfers the input to a rotary switch for selecting a cue for the studio from any of 16 monitor buses in master control. The studio talkback circuit is connected to the monitor amplifier through a relay which disconnects either the cue or monitor circuits. Two microphones are provided, one on the console control panel and one on a panel on the producer's desk. Each is connected to the talkback circuit by a key switch which operates the talkback relay. When either talkback switch is operated, the control room speaker is disconnected and the studio speaker is turned on. Whenever the program line switch is operated, the power circuit to the studio speaker relay is broken, thus preventing talkback while the studio is feeding master control. During these periods, a BA-1A talkback microphone booster is connected to headphones on the stage. These may be used by an announcer or a musical director for taking instructions from the booth during a broadcast. Also as these headphones are normally in the monitor circuit, a musical director can hear the program as it is fed to master control.

One BA-4C amplifier is provided to feed program material to a clients booth which overlooks the studio.

There are supervisory lights on the console that are automatically controlled by the pre-set switching system and indicate to the operator when his studio has been pre-set as well as when his studio has been switched to an outgoing channel. When the operator closes his program key a light in master control is energized showing that the program circuit is complete from microphone to channel output.

#### Facilities for Studio "C," "D," "E" and "F"

Each of these studios is equipped with a standard RCA 76-C console as the nature of programs in these studios is not as complex as in Studio "A" and "B".

In "C" and "D," auxiliary equipment consisting of a jack bay, echo controls sound effects filter and a 24-position cue selector is supplied. This equipment is built into two turrets with sloping panels, one turret located on each side of the console. (See Fig. 9 below).

Studios "E" and "F" do not have a jack bay or a sound effects filter. Studio "E" does have, however, the channel override controls which have been mentioned previously.

A producer's desk and control turret similar to that in Studio "A" and "B" is furnished in both "C" and "D".

#### Summary

The design of the above station facilities has resulted from combining the experience of WMGM engineers with the engineering

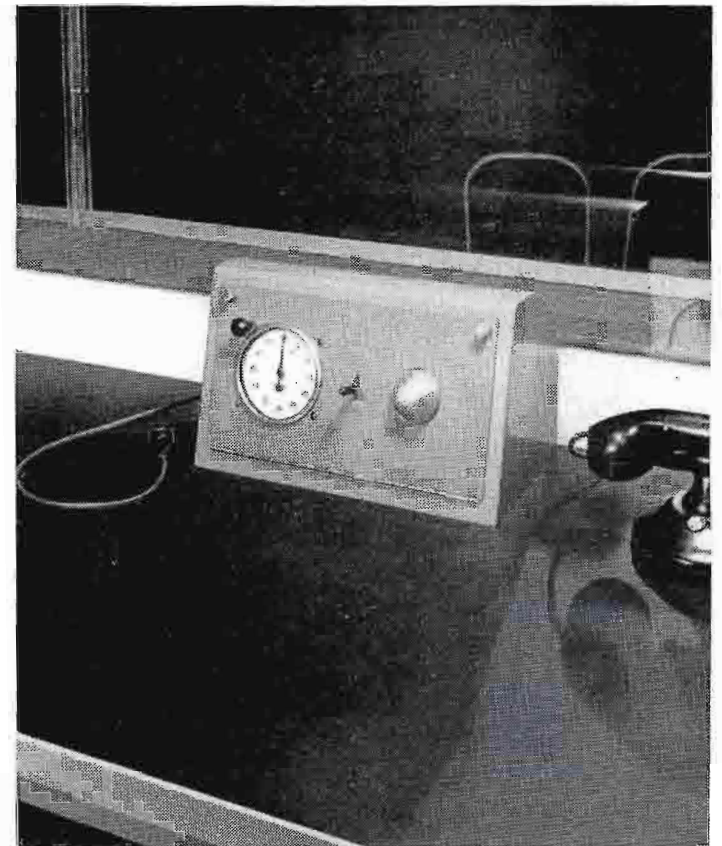

FIG. 8. The program directors' or producers' turret and controls shown here are located adjacent to studio "A" and "B" consoles and consist of talkback microphone, operate switch and timer.

and manufacturing resources of the Radio Corporation of America.

All of the equipment supplied is of the latest design to assure the station high standards of performance, dependability and service.

This provides WMGM with one of the most up to date and finest equipped stations in the country.

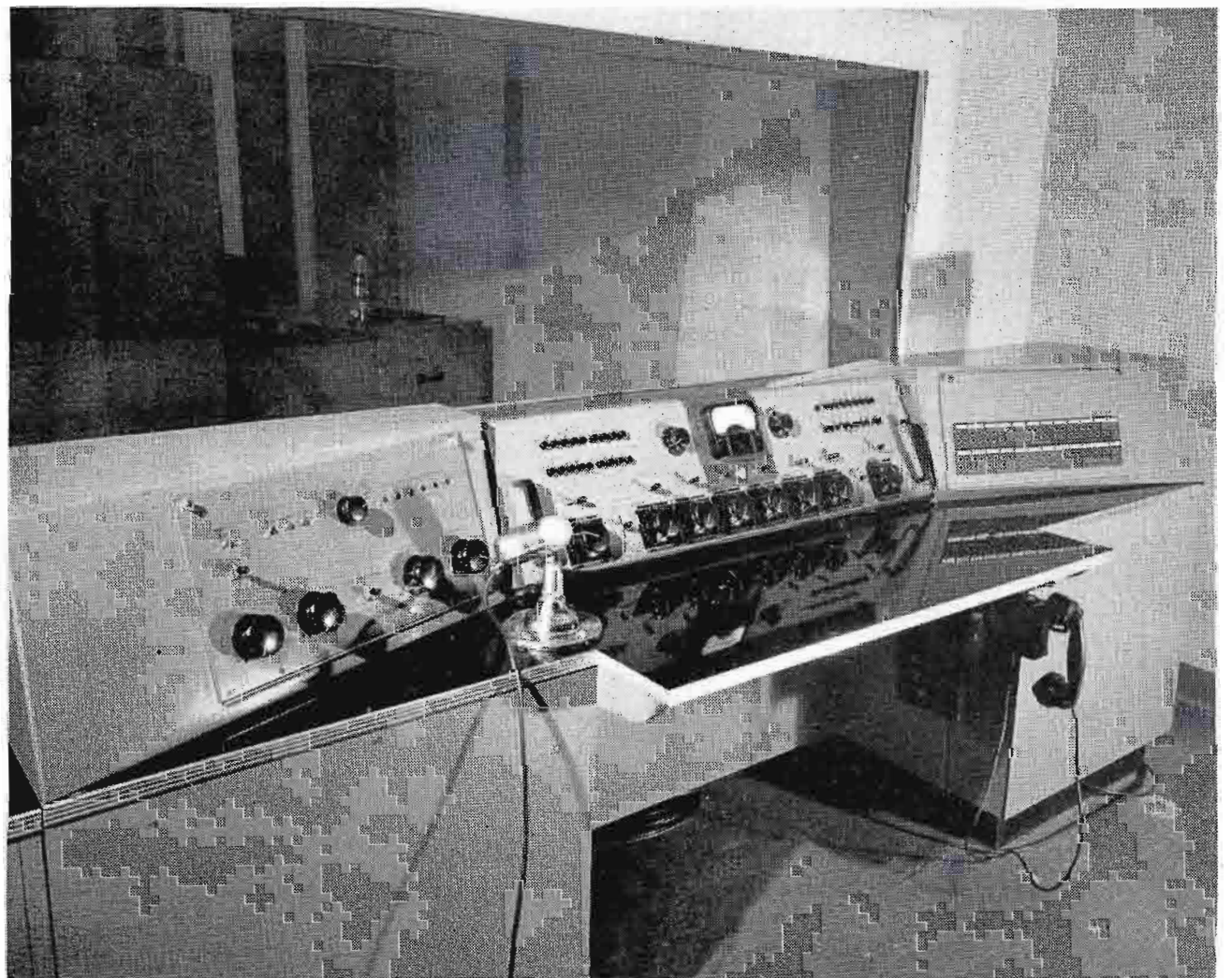

FIG. 9. WMGM studios "C," "D," "E," and "F" all employ standard RCA consolettes "tailored" to suit individual studio needs. The "C" and "D" units like the one above employ auxiliary left and right wing turrets.

# TV BLUEPRINT

by **ROBERT C. DEIGERT**  
and **DAVID N. YERKES**  
Deigert & Yerkes  
Communications Architects, Washington

EDITOR'S NOTE: *The selection and arrangement of facilities for a new television station requires consideration of numerous factors with which the average station owner or manager has had no actual experience. Moreover, the neophyte soon finds that when he questions the experts he gets sharply differing answers. In fact it is obvious that the one certain thing in planning a TV installation is that there will be no certain answers until television techniques have developed further, and there is more honest-to-goodness, down-to-earth experience to go by.*

*Confronted with this situation we have felt that BROADCAST NEWS could best serve its readers by presenting a wide range of ideas on planning and design of TV studios and transmitters. In line with this we have presented previously several articles on TV station planning by well-known architects and engineers.*

*The following article, which continues this series, was originally prepared by the authors for BROADCASTING magazine. It approaches the problem from the viewpoint of the station owner starting from scratch and presents a suggested schedule of steps to be followed in the establishment and expansion of the station. Minimum floor areas considered necessary for various facilities are given, as well as a check list of all of the adjuncts which must be considered in original planning. Sketches of a rather unique studio design are included.*

The problems that confront broadcasters who propose to enter the television field revolve primarily around questions of cost, both of facilities and of operation. This discussion is directed toward the prospective telecaster who must put his operation on a sound economic basis by keeping his investment and operating expenses at a minimum.

Television programming and studio operation are in the initial formative period, and experimentation and operating experience continually demand changes in the facilities needed for programming. It is almost impossible therefore for the broadcaster to anticipate the facilities his station will require to do an adequate job in his community five years from now. He is faced with the danger of investing heavily in a plant which may well become obsolete within a relatively short time.

Sound economic planning for the development of small television stations indicates the wisdom of installing minimum facilities at the beginning of operation. To this basic plant additional facilities can be added as the state of the art advances and as revenue from the station increases. It should be remembered that there will be much wider variation in the facilities needed for rendering complete video service to individual communities than in aural broadcasting. The characteristics of the local audiences, the station budget, availability of facilities, and special program-

ming requirements, will make every station an individual problem requiring careful analysis and expert planning.

The four stages outlined below permit the logical development of television facilities on a reasonable economic basis.

*First Step*—Install transmitters and minimum film equipment.

*Second Step*—Purchase mobile equipment.

*Third Step*—Build minimum studio facilities.

*Fourth Step*—Expand studio facilities to provide for complete program service for the particular community served by the station.

The first step puts the station on the air with minimum initial expenditure and minimum operating costs. Programming will be limited to film and slides. It will probably be found that 16mm film is the most satisfactory for a number of reasons. Free and commercial films are available in considerable quantities and 16mm film is printed on a safety base which, under most city building codes, requires no special fire protection for the projection room or for storage areas.

Probably the most economical operation for this first stage will be to combine the film projection and transmitter facilities in one building if that is possible. If an

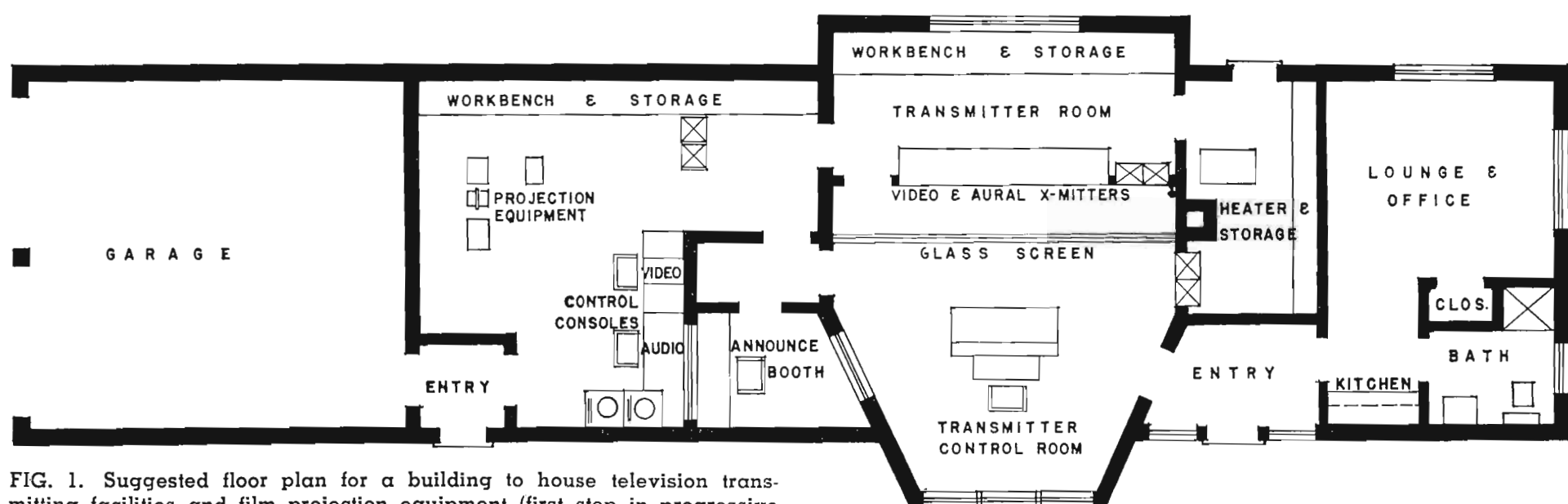

FIG. 1. Suggested floor plan for a building to house television transmitting facilities and film projection equipment (first step in progressive plan outlined by the authors).



existing AM or FM site is suitable for television transmission and an existing tower can be used for supporting the television antenna, a considerable saving will be effected.

The building problem will be further simplified when space is available in the existing transmission building for the installation of the television transmitter and the film equipment. Additional space required for television is as follows: (1) An area of 400-600 square feet for the 5 KW video and aural transmitters, including space for a control console and for tuning and servicing transmitters; (2) a minimum of approximately 120 square feet for film projection equipment.

If sufficient space is not available in the transmitter building the alternative is to build an addition to the existing structure. The necessary floor area in the addition will normally result in cubic contents ranging from 7,000-10,000 cubic feet.

If a new transmission building must be built, the following elements should be considered:

(a) Control and transmitter room. This area may or may not be separated into two rooms. The combined size of a 5 KW video transmitter and 5 KW aural transmitter is approximately  $12\frac{1}{2}$  feet long and 2 feet deep and the area required for servicing, control console, etc., will again range from 400-600 square feet.

(b) A video receiving and equipment room may be needed eventually if not immediately. This will house racks containing receivers (if a radio link to the studios is used), audio and video amplifiers, and perhaps in the future, a film projector to be used in case of line failure.

An area of 120-150 square feet should be provided.

(c) Laboratory, shop, and storage space should be between 100-150 square feet.

(d) Living quarters for the chief engineer: 200-300 square feet.

(e) Combined office and lounge: 150-200 square feet.

(f) Miscellaneous accessory areas such as an entry, bath room, space for a heating unit, closets, etc.: 150-200 square feet.

(g) A visitors' lobby, if required, will demand the enlargement of the entry to an area of approximately 200 square feet.

(h) A garage for passenger cars may be desirable, especially in severe climates or in isolated areas. It should include an area of at least 200 square feet. If a remote pick-up truck is to be housed, a larger garage will be needed.

(i) A motion picture projector room containing a slide projector and one or two film projectors (either 16mm or 35mm), and a work bench. If 16mm film is used, the film pick-up camera can also be installed in this room; for 35mm film the camera and projector must be separated by a masonry wall. The size of the room should be between 70-120 square feet, and the area where the film camera and monitoring equipment are located must be electrically shielded. At the time when the film equipment is moved to a permanent studio location the area it occupies can be allocated to other facilities.

Some of these elements may not be needed in a particular locality and they may be related to each other in a number of different ways. The figures given represent average space requirements. Specific total requirements may vary from 1,000-2,500 square feet for a simple, if not min-

#### ABOUT THE AUTHORS

Mr. Robert Deigert and Mr. David Yerkes, the authors of this article, are partners in the firm of Deigert & Yerkes, Communications Architects. This firm, which has its offices at 3211 "O" Street, Washington, D. C., specializes in studio and transmitter building design. During the past twelve years they have designed studio and transmitter buildings for a large number of broadcast stations, some of the more recent ones being: WASH-FM and WINX, Washington; WMCP-FM, Baltimore; WDNC, Durham; WVUN-FM, Chattanooga, KVUN-FM, Los Angeles; WRUN, Utica; KUBR-FM, St. Louis; WINQ-FM, Uniontown.

imal operation. The cubic contents will range from 12,000-32,000. A typical transmitter building incorporating film service is shown in Fig. 1.

Step two entails the purchase of mobile equipment. This will allow programming of local sports and civic events and will make possible some studio presentation through the use of rented space in local auditoriums and theaters, utilizing the field cameras and field monitoring equipment. This step involves no additional building construction.

Step three requires the building of a single studio and control room with minimum adjunctive facilities.

At the present time there are as many opinions regarding studio and control room design as there are television operators. At the risk of incurring some criticism, and with the hope of encouraging discussion, a new type of studio-control room

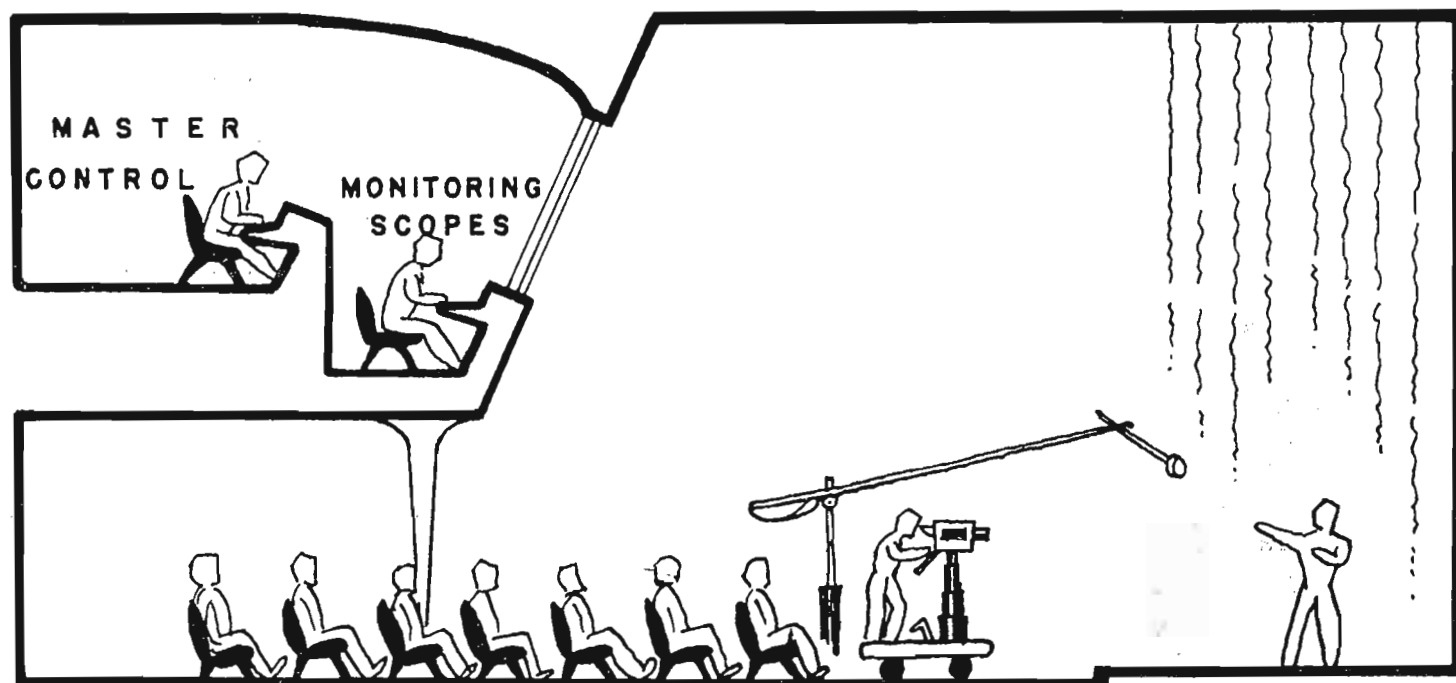
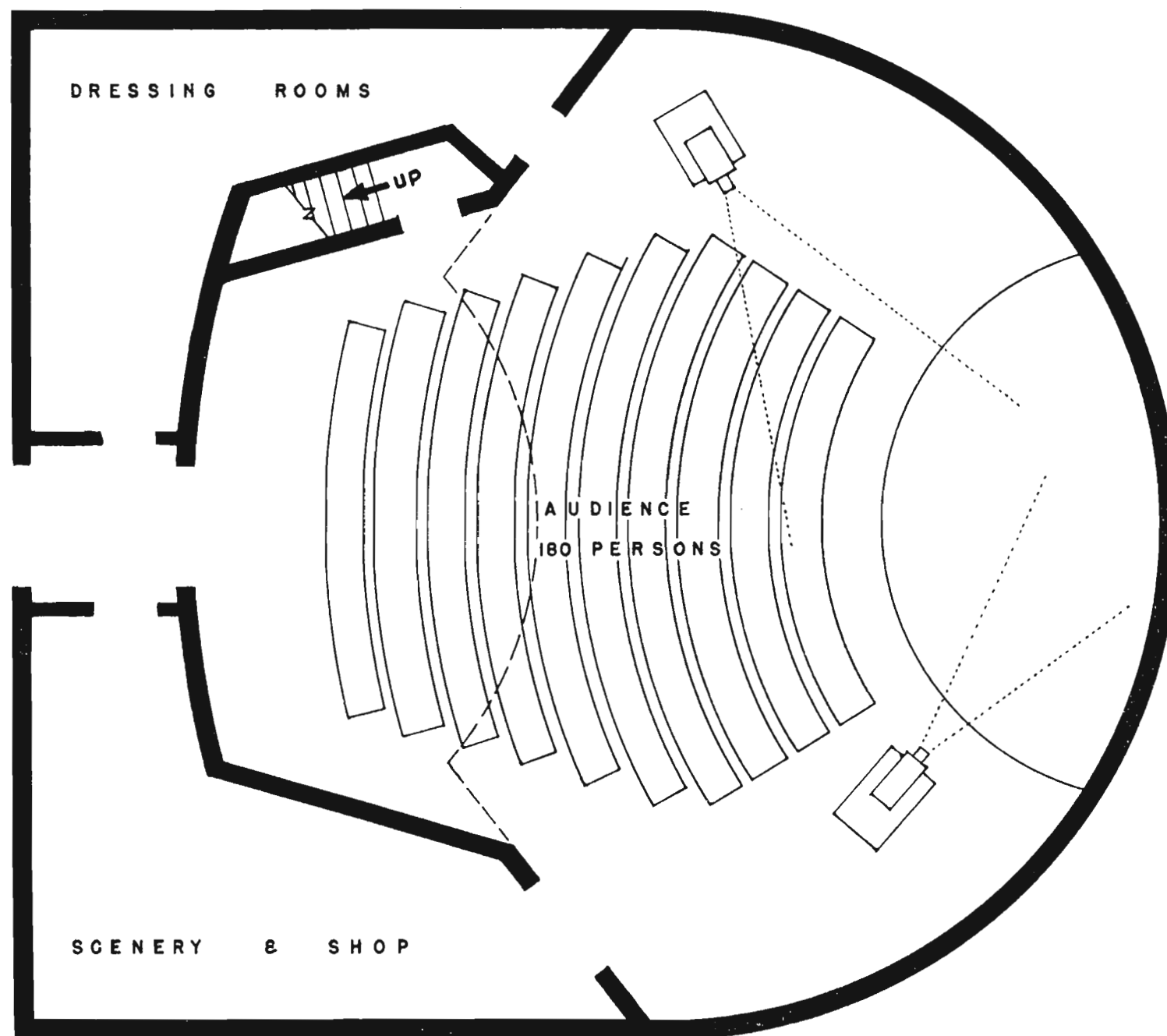

FIG. 2. Section through studio and control room of the studio plan shown in Fig. 3 and Fig. 4 (following pages).

FIG. 3. First floor of the studio design suggested by Deigert and Yerkes. Arrangement of cameras for audience participation show is indicated.



layout is shown in Fig. 2. This plan offers simplified camera placement in shifting scenes, provides for audience viewing, audience participation, or straight studio work. Flexible arrangements for from one to five sets of varying sizes are provided in a minimum area. The control room is placed on the second floor level with a convenient stair for access to the studio. The ceiling height is 22 feet, allowing room for sizable sets yet giving sufficient height for lighting, high angle camera placement, etc. The studio (including control room) has about 1,800 square feet of floor area, and contains approximately 40,000 cubic feet.

In step four the facilities are added which are necessary to bring the station to full programming capacity for the community it serves. The operating know-how and experience gained by the broadcaster prior to this stage will enable him to determine the facilities required for a complete programming service. Limited space prevents a discussion of all the elements to be considered for complete facilities, but a brief outline check list is given below.

#### Check List of Elements Desired

- |   |  |
|---|--|
| <ol style="list-style-type: none"> <li>1. Studios             <ol style="list-style-type: none"> <li>(a) Approximate sizes                 <ol style="list-style-type: none"> <li>A.....</li> <li>B.....</li> <li>C.....</li> </ol> </li> <li>(b) Audience participation desired...                 <ol style="list-style-type: none"> <li>(1) in which studio.....</li> <li>(2) size of audience.....</li> </ol> </li> <li>(c) Audience viewing desired.....                 <ol style="list-style-type: none"> <li>(1) in which studio.....</li> <li>(2) size of audience.....</li> </ol> </li> <li>(d) Clients viewing desired.....                 <ol style="list-style-type: none"> <li>Where.....</li> </ol> </li> </ol> </li> <li>2. Master control.....</li> <li>3. Sub control.....             <ol style="list-style-type: none"> <li>A.....</li> <li>B.....</li> <li>C.....</li> <li>D.....</li> </ol> </li> <li>4. Film projection facilities             <ol style="list-style-type: none"> <li>(a) Projection booth.....</li> <li>(b) Film storage.....</li> </ol> </li> </ol> | <ol style="list-style-type: none"> <li>(c) Film camera room.....</li> <li>5. Shop .....</li> <li>6. Video effects shop.....</li> <li>7. Equipment storage.....</li> <li>8. Scenery and property shop.....</li> <li>9. Scenery and property storage.....</li> <li>10. Power room.....</li> <li>11. Emergency power room.....</li> <li>12. Air conditioning and heating room....</li> <li>13. Dressing rooms.....             <ol style="list-style-type: none"> <li>(a) Stars.....</li> <li>(b) Male talent .....</li> <li>(c) Female talent .....</li> </ol> </li> <li>14. Costume storage .....</li> <li>15. Toilet facilities             <ol style="list-style-type: none"> <li>(a) Operators.....</li> <li>(b) Staff .....</li> <li>(c) Talent .....</li> <li>(d) Public .....</li> <li>(e) Office .....</li> </ol> </li> <li>16. Musicians' room .....</li> <li>17. Instrument storage .....</li> </ol> |
|---|--|

FIG. 4. Second floor of the studio showing studio and control room arranged for programs with no audience. Four separate sets can be accommodated. Minimum camera movement is required and control operators have a good view of all sets.

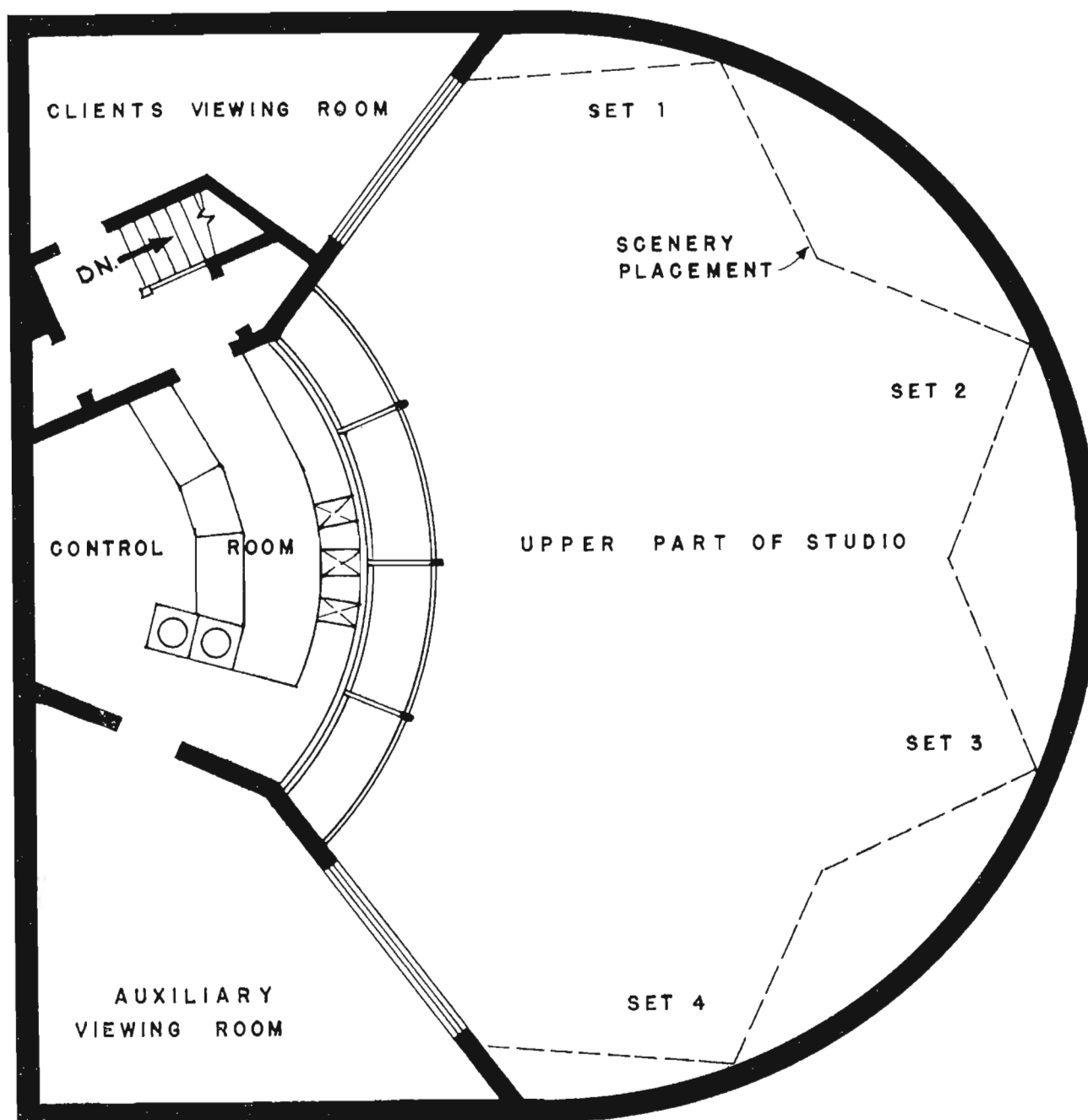

- 18. Lobby (public).....  
(public telephone)
- 19. Reception—telephone switchboard ...
- 20. Staff lounge .....
- 21. Talent lounge .....
- 22. Offices
  - (a) Station director .....
  - (b) Program director .....
  - (c) Chief engineer .....
  - (d) Sales manager .....
  - (e) Sales office .....
  - (f) Bookkeeping .....
  - (g) Traffic .....
  - (h) Public relations ... ..
  - (i) Program producers—  
4 producers.....
  - (j) Script writer.....
  - (k) Special events director.....
  - (l) Art director.....
  - (m) Library .....
  - (n) General office.....
  - (o) Office supply storage.....

Our postwar experience shows that costs today are two to three times as high as those of 1939, and in general this applies to all sections of the country. The usual rule of thumb for estimating building costs is the cubic foot basis. To obtain the cubage in your proposed structure, measure from the top of footings to the upper surface of the roof for the height, and multiply this by the area of your building in square feet. For unfinished spaces such as basements and garages the cost can be estimated as two-thirds of that of the finished portion of the building. Our experience with transmitter buildings built during the last year in all parts of the country reveals a cubic foot cost from \$1.25 to \$1.50 in locations easily accessible for building operations.

Inaccessible locations such as mountain tops, etc., where materials and workmen must be transported a considerable distance, will increase the cost. In general, studio construction will be more expensive than transmitter building construction due to the incorporation of air conditioning and acoustical work. Cubic foot costs will

depend largely on the degree of elaboration of your studio layout and will vary from \$1.35 a cubic foot to \$2.50 a cubic foot or higher. Prices are for finished studios.

Your architect should be a communications specialist. He should have a thorough understanding of television operation and equipment, since he is the final coordinator of the requirements for your engineering, programming, air conditioning, electrical service and plumbing. The structure and workability of your plant will be largely dependent on him. Allow as much time as possible for planning your facilities, for your success will be directly related to the painstaking development and coordination of each of the elements of your station.

(The authors wish to express their appreciation of the guidance given in preparing this article by the following television experts: J. Henry Hoskinson, WMAL-TV, Washington; Millard M. Garrison, Chambers & Garrison, consulting radio engineers; and Philip Merryman, consulting radio engineer. The authors take full responsibility for the ideas expressed.)

# A NEW 150 KW AM TRANSMITTER\*

By T. J. BOERNER

Transmitter Engineering Section  
Engineering Products Department

## Introduction

Radio broadcasting service in most densely populated centers of the world is now handled economically by a plurality of medium power transmitters located at strategic points adjacent to the population centers. High power radio broadcast service employing medium frequency, amplitude modulated transmitters provides an unexcelled, economical vehicle for education and entertainment of large population groups in sparsely settled areas. The modern 150 kilowatt transmitter described herein was designed to meet the need for service in these areas. Fundamentals were established in 1946. Design considerations and performance specifications are presented here along with illustrations and performance data on the final product.

## Basic Design

The prime design objective was an efficient, compact transmitter capable of delivering fine performance economically. New design features reflect full cognizance of prior art on medium frequency broadcast transmitters. Circuits, tubes and components were investigated.

A carrier frequency range of 540 to 1600 kilocycles per second was chosen as the band in greatest use internationally for medium frequency broadcasting. The high level system wherein a class C final amplifier is amplitude modulated by a class B modulator was the final circuit choice, after a study of high efficiency systems to select the most advantageous circuits for 150 kilowatts carrier output. The highest overall efficiency of the high level system along with the relative ease of adjustment outweighs the disadvantages of such factors as additional tubes and large size modulator components. Lowest total power input results in power savings which would otherwise be a major operating cost factor at many of the locations where the transmitter would be installed.

An operational advantage of the high level system is the ease with which the transmitter can be adjusted by operating personnel of limited skill to maintain high quality performance. This advantage is due to the fact that a moderately economical tube complement provides the required

performance without the use of overall feedback which normally calls for critical radio frequency circuit adjustment. The final radio frequency power amplifier in the high level system is driven well beyond saturation thus swamping hum generated by a-c filament heating as well as providing ample grid swing for modulation peaks.

The disadvantage of higher initial tube cost in the high level system is not an important factor in overall economy because operating conditions are conservative thus resulting in exceptionally long tube life. Size of modulation transformer and reactor are not an imposing problem because circuit advances and transformer design techniques learned in recent years have resulted in reduced size and lower cost of these components. Combined weight of transformer and reactor in recent 50 kilowatt high level transmitters is 9,700 pounds as compared to 20,000 pounds in a transmitter of the same rating designed in 1938.

The 9C21 water cooled tube was chosen for use in the final amplifier of the audio and the radio frequency systems. Prior experience with the 9C22 tube, the air cooled counterpart of the 9C21, for power amplifier and modulator service in 50 kilowatt high level transmitters has been entirely satisfactory. Average life at the first installation using this tube type has passed the 10,000 hour mark. Some higher power tube types are in existence but operating experience did not appear to be sufficient to warrant their consideration.

High power rectifier tubes considered were the type 870-A and the type 857-B. The 870-A was considered from the standpoint that one rectifier could be used for d-c voltage supply to both the power amplifier and the modulator. In this case d-c voltage is limited, by the modulated rating of the 9C21, to 12.5 kilovolts for radio

\* Courtesy of American Inst. of Elec. Engineers.

FIG. 1 (at left). Shown here inspecting the 150 KW transmitter during production tests are left to right: Meade Brunet, Vice President of RCA and Managing Director of International Division; Frank M. Folsom, President of Radio Corporation of America; and W. W. Watts, Vice President of RCA in charge of the Engineering Products Department.

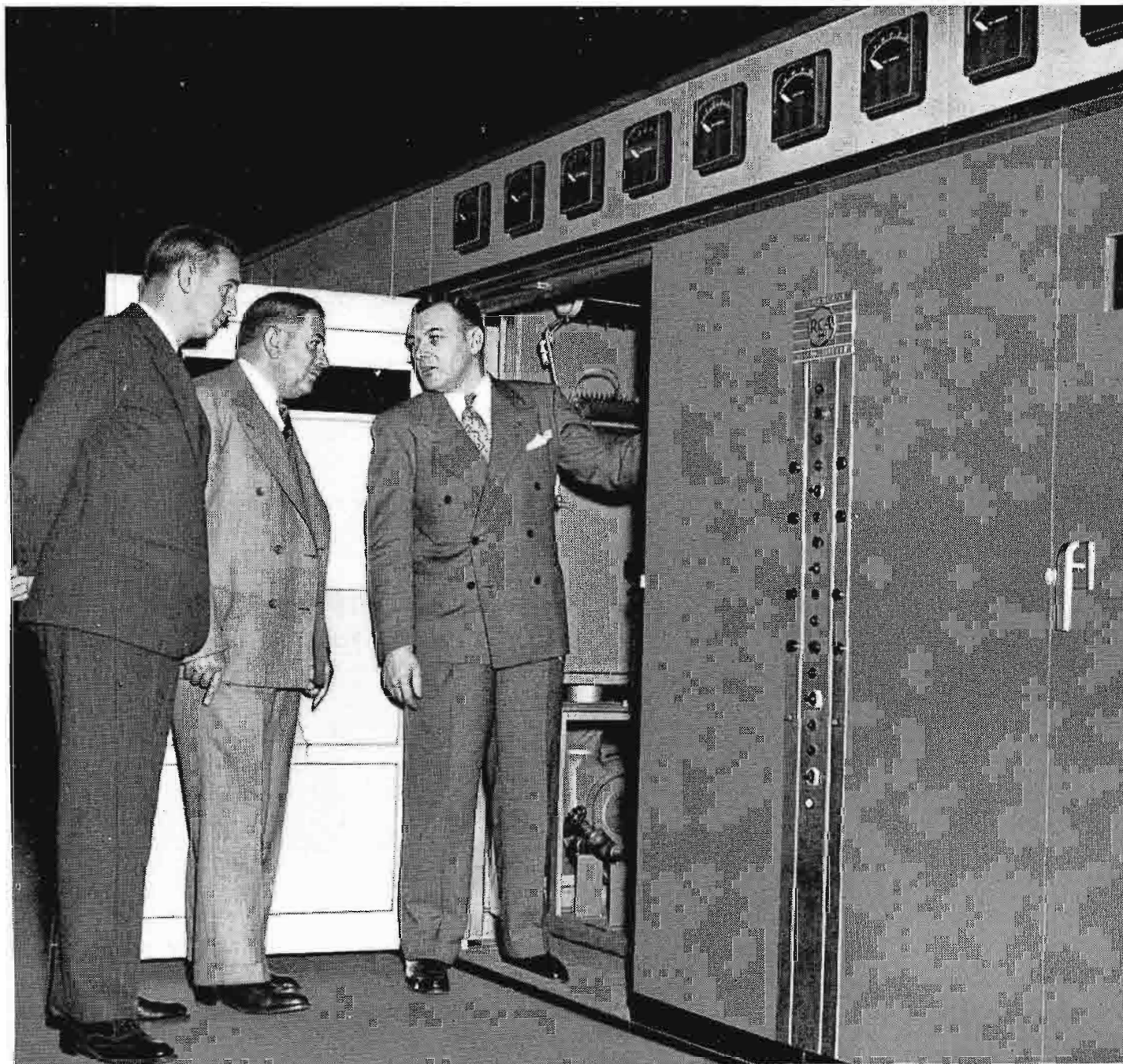

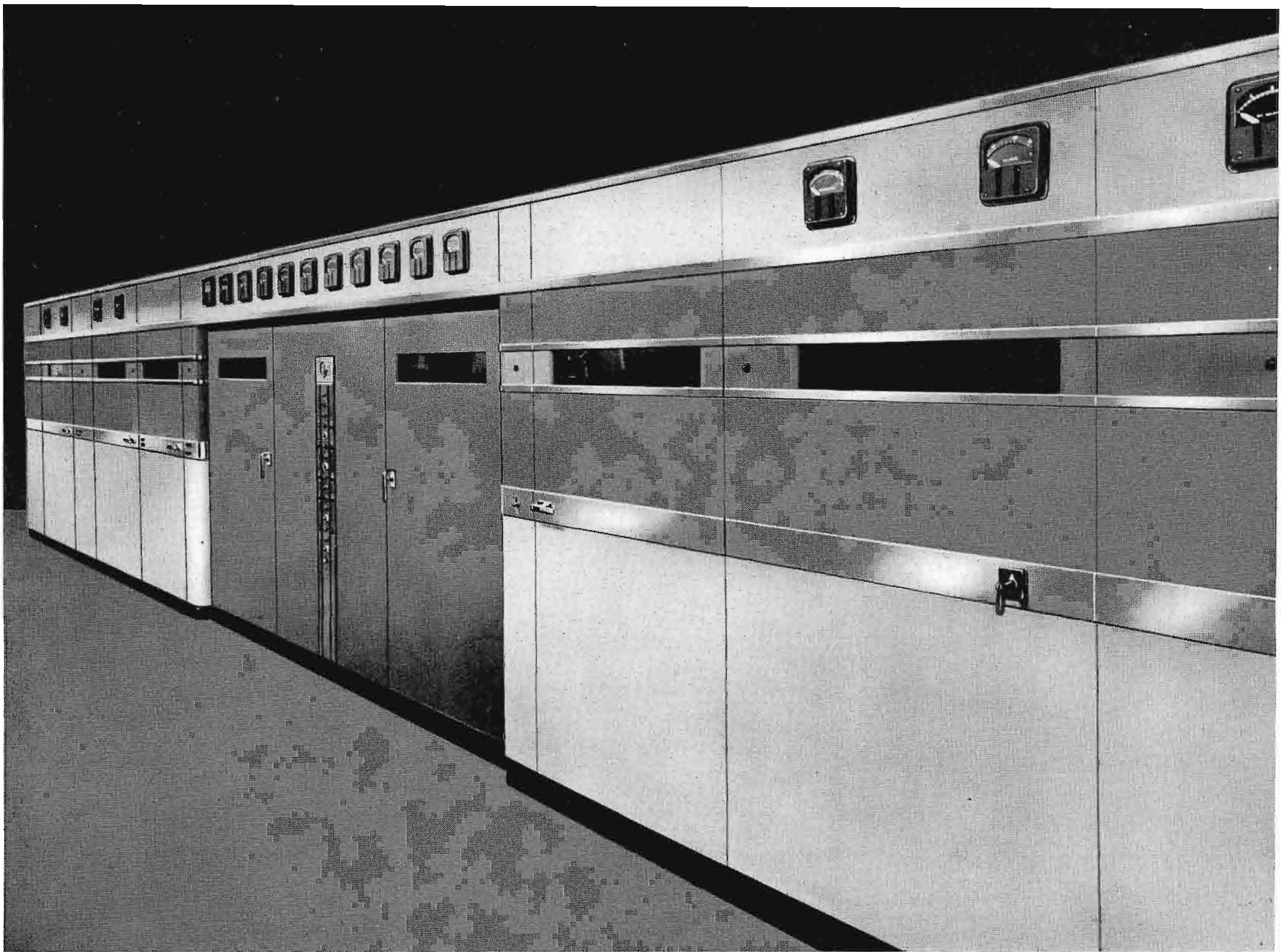
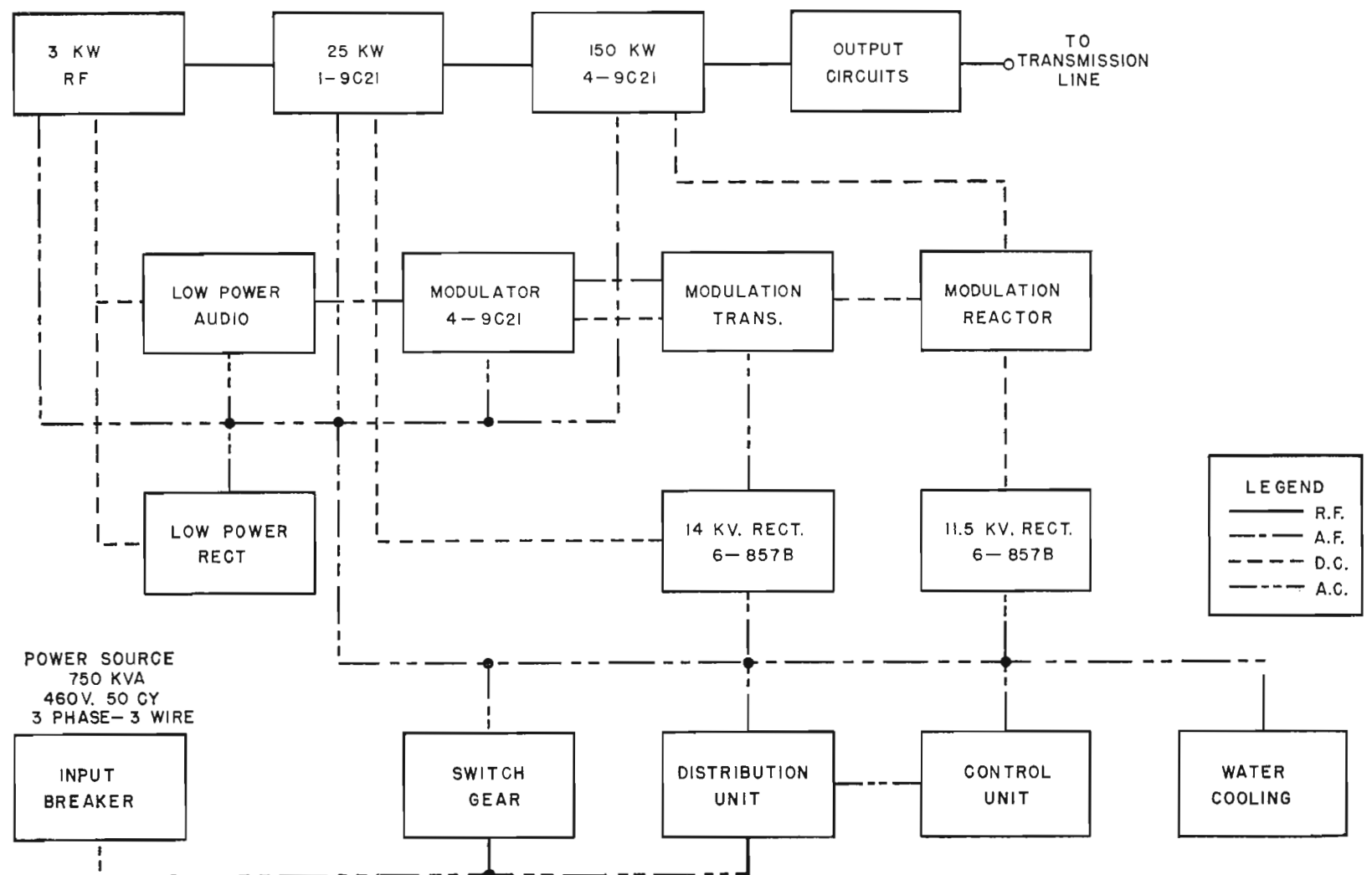

FIG. 2 (above). The final 150 KW transmitter design, as set up in "53" engineering building for final tests. All transmitter components are installed behind the unified front panel which presents a streamlined appearance. Radio Istanbul, powerful new voice of Turkey, is covering that country and the middle east with one of these new transmitters.

FIG. 3 (at right). Transmitter design is simplified in order to use a minimum of components, as illustrated by the block diagram shown here.



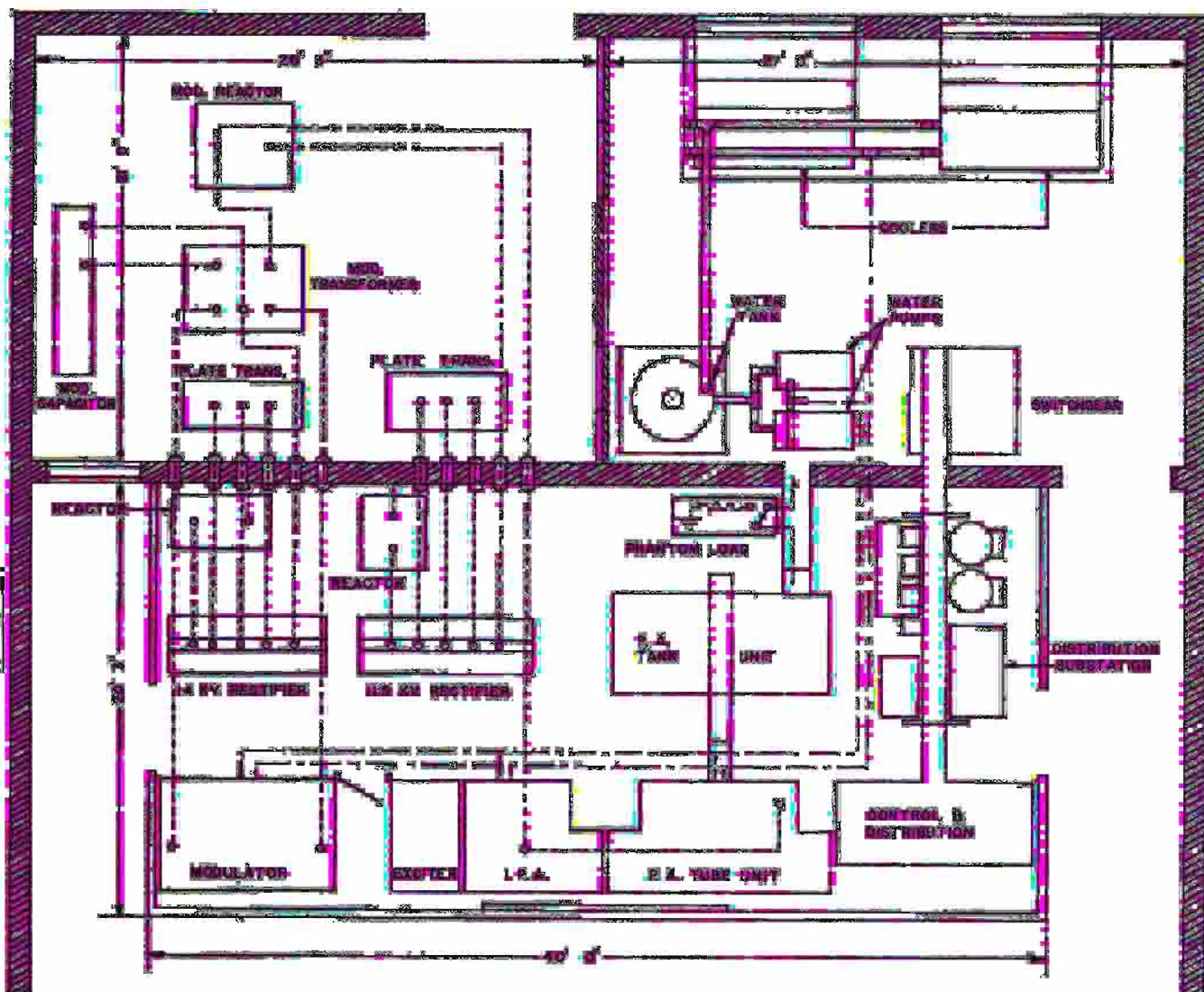
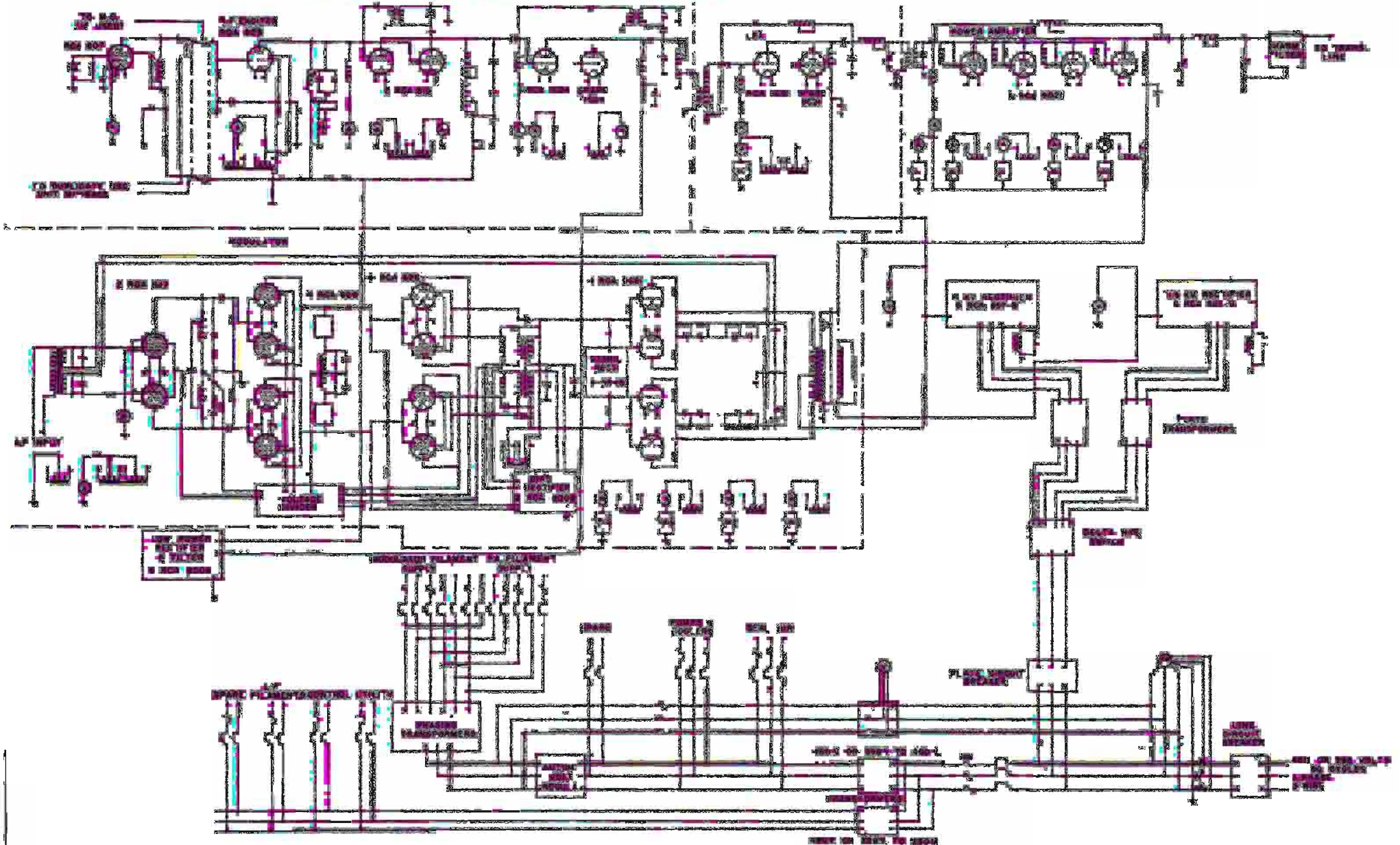

FIG. 4 (above). 150 KW AM transmitter floor plan layout which shows how all transmitter units may be located on one floor level.

FIG. 5 (below). Simplified schematic diagram illustrating the fundamental circuits of the 150 KW broadcast transmitter. Circuit design includes high level modulator and single-ended amplifiers. Note that same type tube is used in P.A. and modulator.



frequency power amplifier service. A conservative operating figure is 11.5 kilovolts. At this voltage six type 9C21 modulator tubes would be required to modulate four type 9C21 power amplifier tubes because of the grid current requirements in modulator service. A driver of many times the power capability of the actual final design choice would have been required for a modulator tube complement of four 9C21 tubes at 11.5 kilovolts. The alternative of two rectifiers, one operating at 11.5 kilovolts to supply four 9C21 power amplifier tubes and the other at 14 kilovolts to supply four 9C21 modulator tubes, was chosen as the more economical system. Each rectifier operates with six 857-B tubes in a three-phase full wave circuit. The cost of twelve 857-B's as compared with the cost of six 870-A's plus two extra 9C21's required in the modulator reflect a saving of approximately \$5000.00. These savings neglect the additional cost for six versus four modulator tube positions. Cost of spare tubes must also be considered. The two high tension rectifier transformers are energized from a single control breaker so that no additional expense is involved in the primary supply.

Savings were also realizable on rectifier filter components. Ripple voltage on the power amplifier supply could be considerably higher than would be required for

the modulator because of the filtering contributed by the modulation reactor. The separate criteria for modulator and power amplifier filtering resulted in a lower total filter component kva than would have been the case with a single rectifier. The saving appeared to be greater than the cost of the additional rectifier.

The advantages of air cooling versus water cooling were studied. The final decision was in favor of water cooling because of dissipation limitations on available air cooled tubes such as the 9C22. Here again two additional tubes would have been required in the modulator for air cooled operation and the additional cost along with a cumbersome air duct system appear to outweigh the lower maintenance advantage of air cooling. A study of water cooling circuits using four 9C21's in the power amplifier and four in the modulator indicated that a simple system with moderate pressure and with water flow in series through each pair of tube jackets would suffice.

A 460 volt three-phase power supply was selected as the most economical to meet the technical requirements. Particular attention was paid to the necessity for high speed protection on rectifier arc backs and high power tube gas flashes. 460 volt

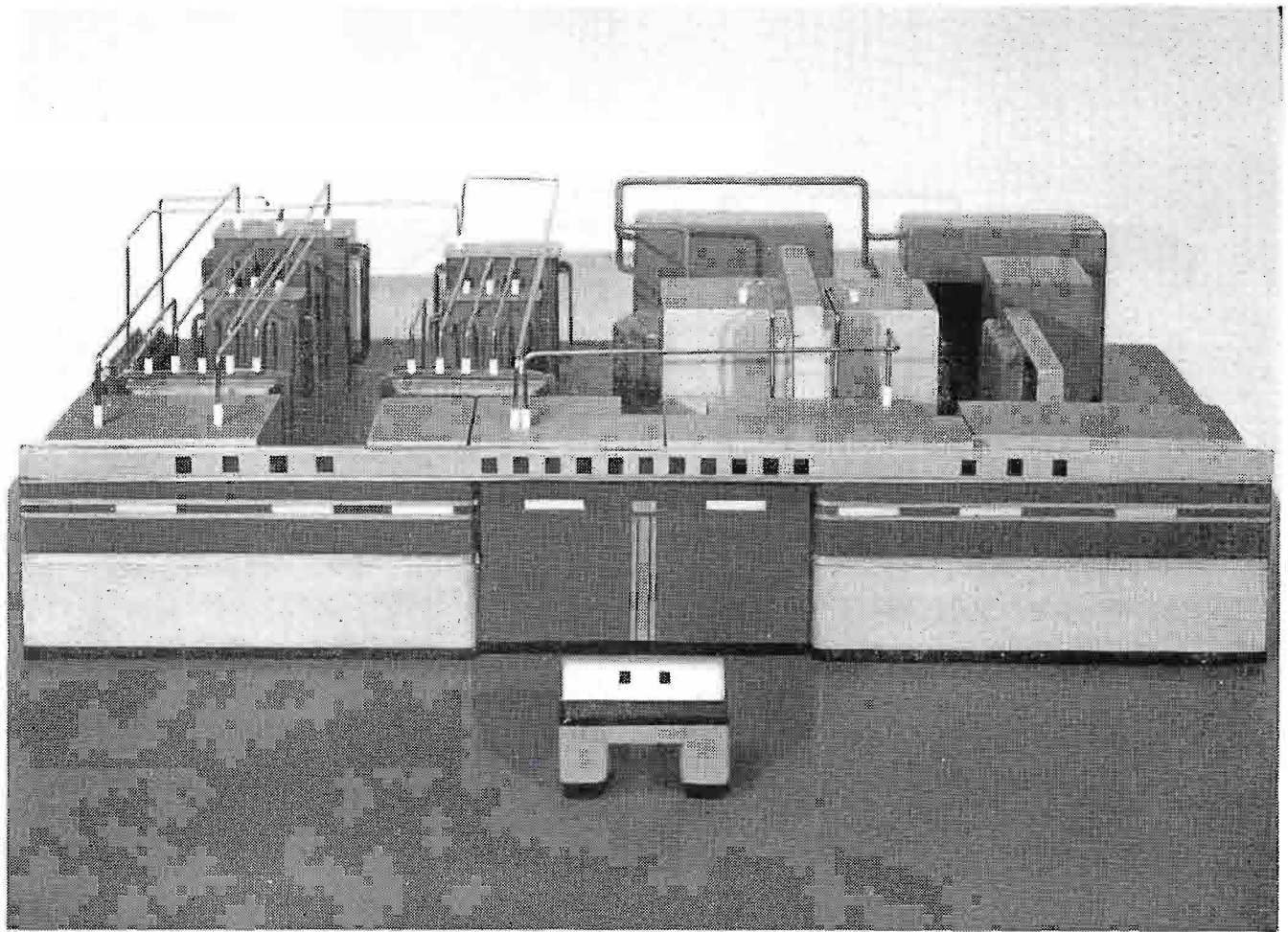
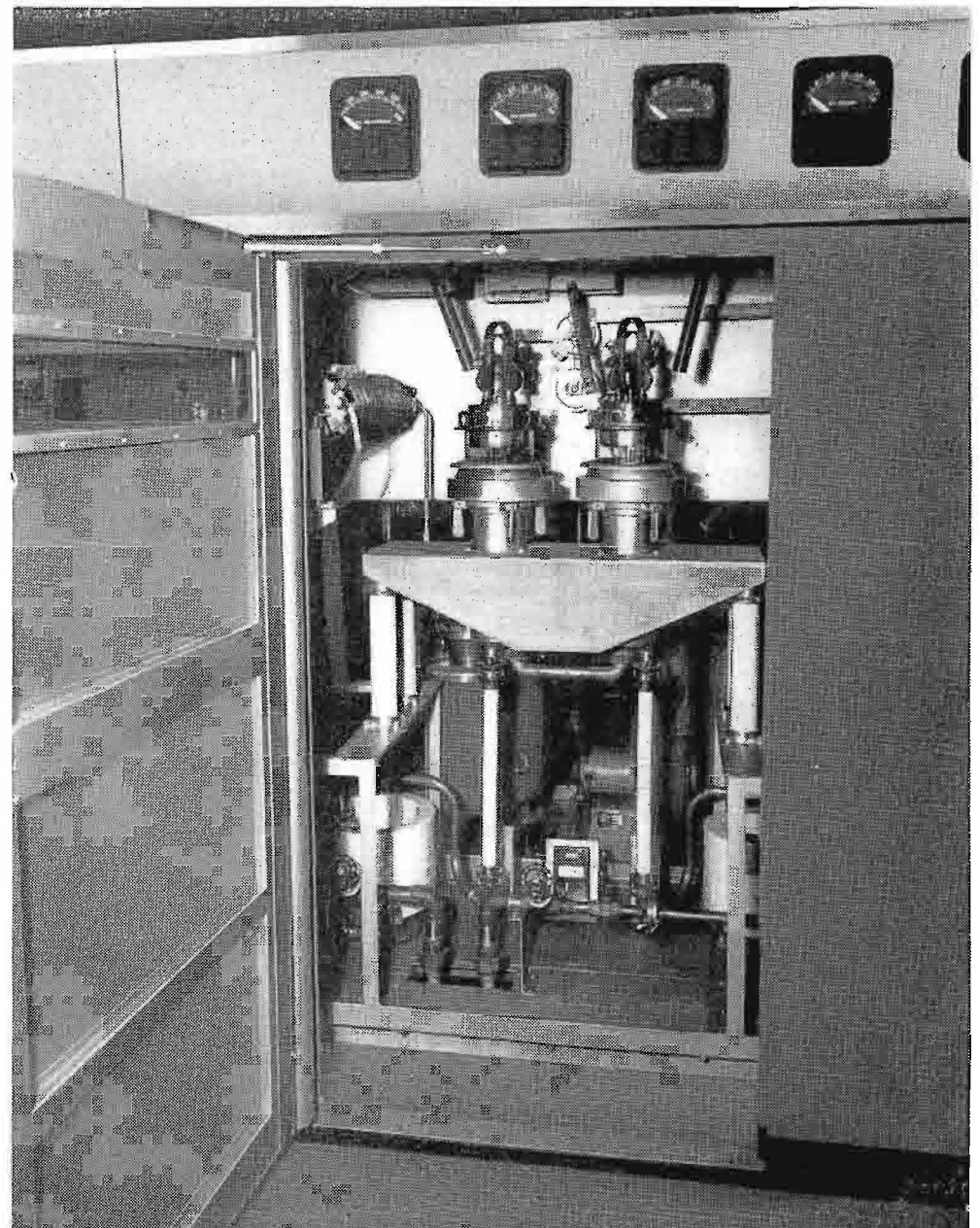
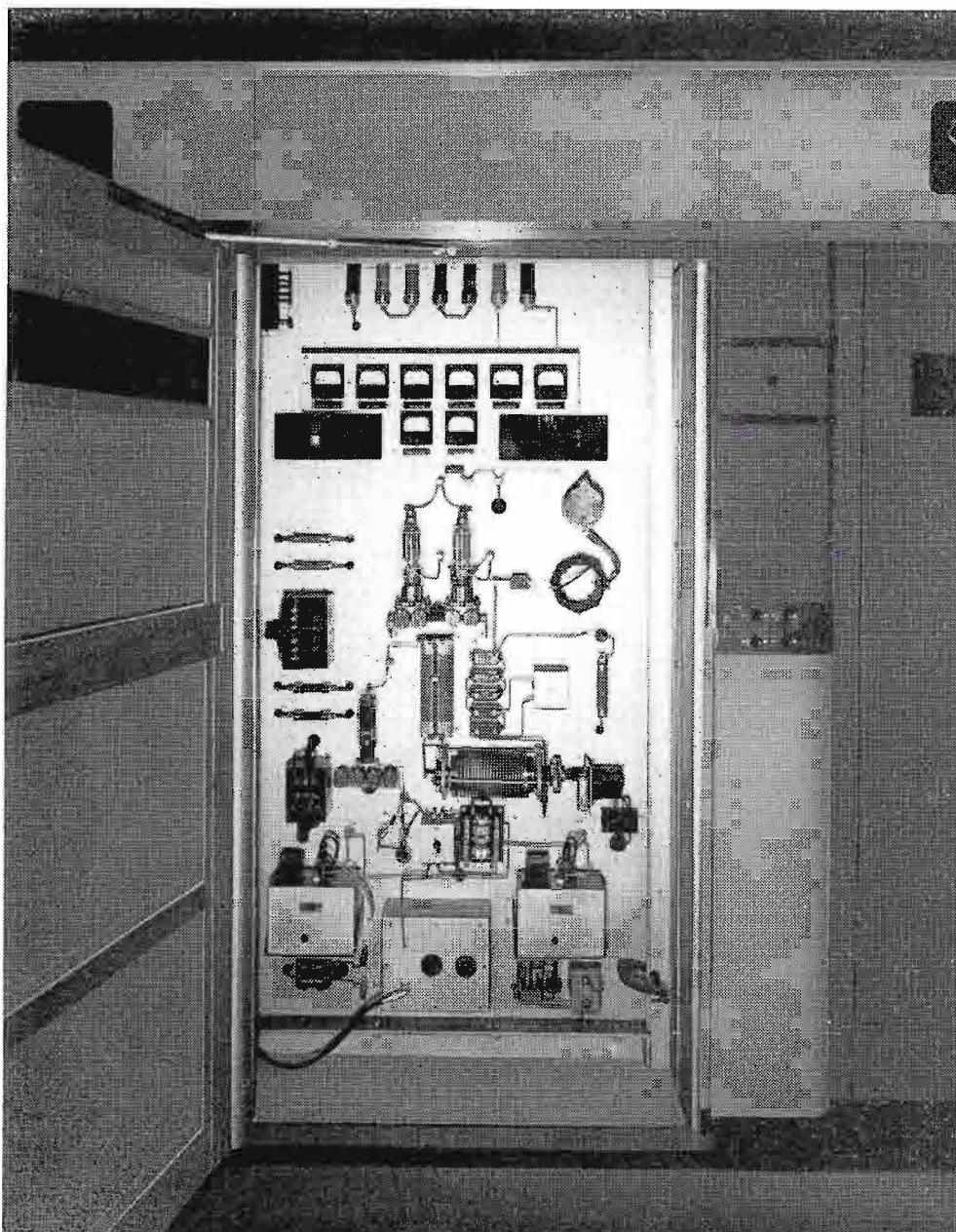

FIG. 6 (above). Early design scale model of the 150 KW AM transmitter showing arrangement of all transmitter components in a single enclosure.

FIG. 7 (left below). Closeup front panel view of cabinet housing crystal oscillators, buffer amplifier and first intermediate amplifier.

FIG. 8 (right below). Open-door, front view of the 15 KW intermediate amplifier showing spare 9C21 tube in place.



switch gear provides the required protection speed at a cost substantially less than that of switchgear operating on higher voltages. A further advantage of the low voltage system results from the fact that a 300 volt power supply is standard in a number of countries where the transmitter might be installed. The transmitter design proceeded on the basis that operation at either 460 or 380 volts was possible by means of taps on the two main rectifier transformers and on two auxiliary transformers included as part of the transmitter.

Performance specifications were set up and are referred to later along with actual performance data. Certain other features were included to improve reliability for broadcast operating groups. Provision is made for emergency operation at reduced power with half the number of power am-

plifier and modulator tubes. The two radio frequency amplifiers preceding the final stage were equipped with an extra tube socket. A spare tube can be in place with water and air applied so that it is ready for immediate connection of filament, grid and plate supply in case of failure of the active tube. A water cooled dummy load is provided for convenience on initial set up, routine maintenance measurements, or subsequent line up during transfer to another operating frequency. Water coolers and pumps are in duplicate although one pump and one cooler will be sufficient on normal operation at most times. Both coolers are required only when cooling air temperature exceeds 40 degrees centigrade. Final installation atmospheric conditions were considered. Design proceeded on the basis that full power operation could be

realized at 8000 feet above sea level. Fig. 3 is a block diagram showing major components and tubes of the final design.

#### Detailed Description

Fig. 6 is a photograph of a model of the complete transmitter as it would appear if installed on a single floor. A fire-proof wall between the transmitter and the oil filled apparatus is omitted in this view. It will be noted that rear access space to individual units was well planned. Fig. 4 is a floor plan corresponding to Fig. 6 showing dimensions of the space required for installation and disposition of various units described in subsequent paragraphs. Design was co-ordinated so that installation with a two floor layout would require no more floor space, the auxiliary equipment being mounted on the lower floor directly beneath the transmitter.

Figs. 3 and 5 show fundamental circuits incorporated in the final design. The radio frequency chain starts with a highly stable, electron coupled crystal oscillator of a type approved for use in broadcast transmitters by the Federal Communications Commission of the U. S. A. Duplicate oscillators are provided with means for switching instantaneously from one to the other without loss of program. A switch is available to select an external frequency source if so desired. A buffer amplifier consisting of one RCA 828 pentode tube with conventional tuned circuits follows the oscillator. Voltage dividing capacitors in the buffer tank circuit provide a source of radio frequency voltage to an external frequency monitor.

The first intermediate amplifier consists of two 810 triodes in parallel with transformer neutralization and variable inductor plate tuning. The following stage using one 7C24 triode has similar circuits and provides an output of approximately 2 KW to the third intermediate amplifier by means of inductive coupling. The latter stage, preceding the final power amplifier, uses one 9C21 triode inductively neutralized and with plate tuning accomplished by two variable pressurized gas capacitors in a pi network. Output of approximately 15 kilowatts is supplied to drive the final power amplifier. The use of inductive interstage output coupling in the two stages preceding the final amplifier was incorporated to prevent mutual coupling through heavy current ground paths which would occur if a simpler direct coupling method had been used.

The final power amplifier circuits are similar to the preceding stage. Output coupling control is provided through varia-

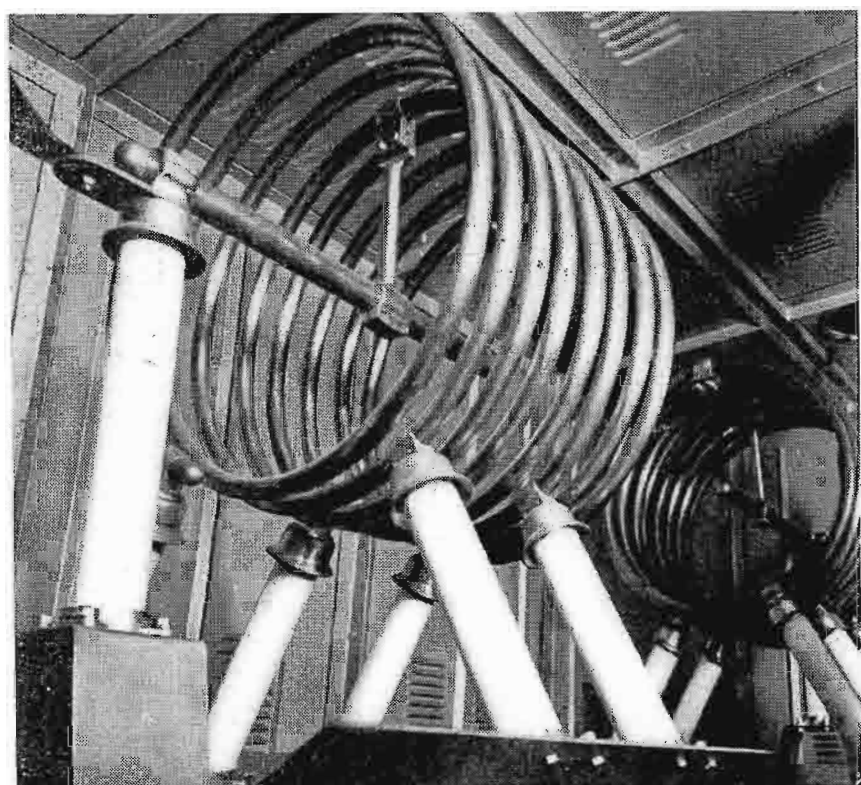
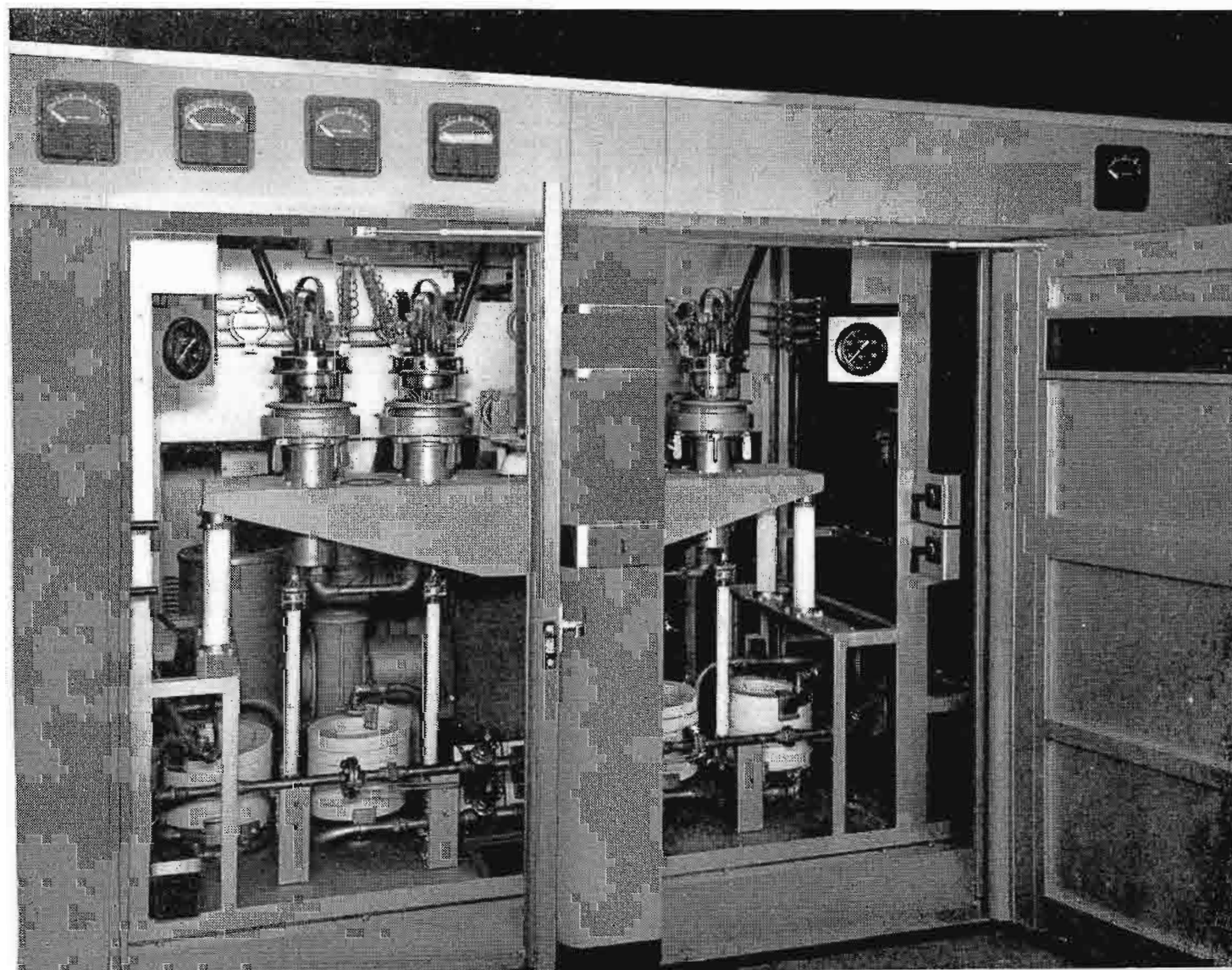

FIG. 9 (at left). Closeup view of the 150 KW power amplifier plate-tank coil.

FIG. 10 (below). In this view doors to the 150 KW power amplifier are opened to illustrate the assembly of the four 9C21 power tubes on a single base plate.





tion of the output capacitor of the plate circuit pi network. A wide range of power output control is obtained by varying this capacitor with little effect on plate efficiency. A harmonic filter is interposed between the power amplifier output and the transmission line input. It is equipped with inductive and capacitive elements arranged so that a T or pi network can be used depending on which is more effective in suppressing harmonics at any harmonic load impedance encountered on final installation. The transmitter is rated normally to deliver power to a load impedance of  $230 + j0$ , the characteristic impedance of a 6 wire open line such as frequently used to carry transmitter power to the base of the radiator. Special components can be used for mounting in the harmonic filter where load impedance is a 50 to 70 ohm coaxial transmission line. In the latter case the harmonic filter serves as an impedance transformer as well as a harmonic attenuator.

It will be noted that all vacuum tubes in the radio frequency chain have individual cathode current ammeters and that all tubes with a rating of 2 kilowatts or higher are equipped with individual over current relays which act to remove plate voltage supply in case of tube overloads. Single ended circuits are used throughout the radio frequency chain for minimum number of components and simplicity in adjustment. The single ended design also avoids the complication of push-pull to single ended coupling for the final output. Circuits which might be responsible for spurious oscillation or harmonic resonance were kept to an absolute minimum. Inductance in the path from power amplifier plates to cathodes through the blocking capacitor and tank capacitor was held to a very low value through proper physical placement of components and the use of low inductance interconnections. Motor drive on the tuning capacitors made possible the most advantageous placement of these units. Spurious oscillations between parallel power amplifier tubes was avoided by grouping the plates on a common assembly and using the familiar resistor-inductor suppressor on individual grid connections.

Filament heating supply to the power amplifier tubes is double quarter phased so that each filament is excited 45 degrees advanced in phase from its adjacent tube. Single phase filament excitation will result in hum components of twice the power frequency due to the magnetron effect. Quarter phasing will eliminate the double frequency component and leave only those components of four times the power frequency or higher. The corresponding hum

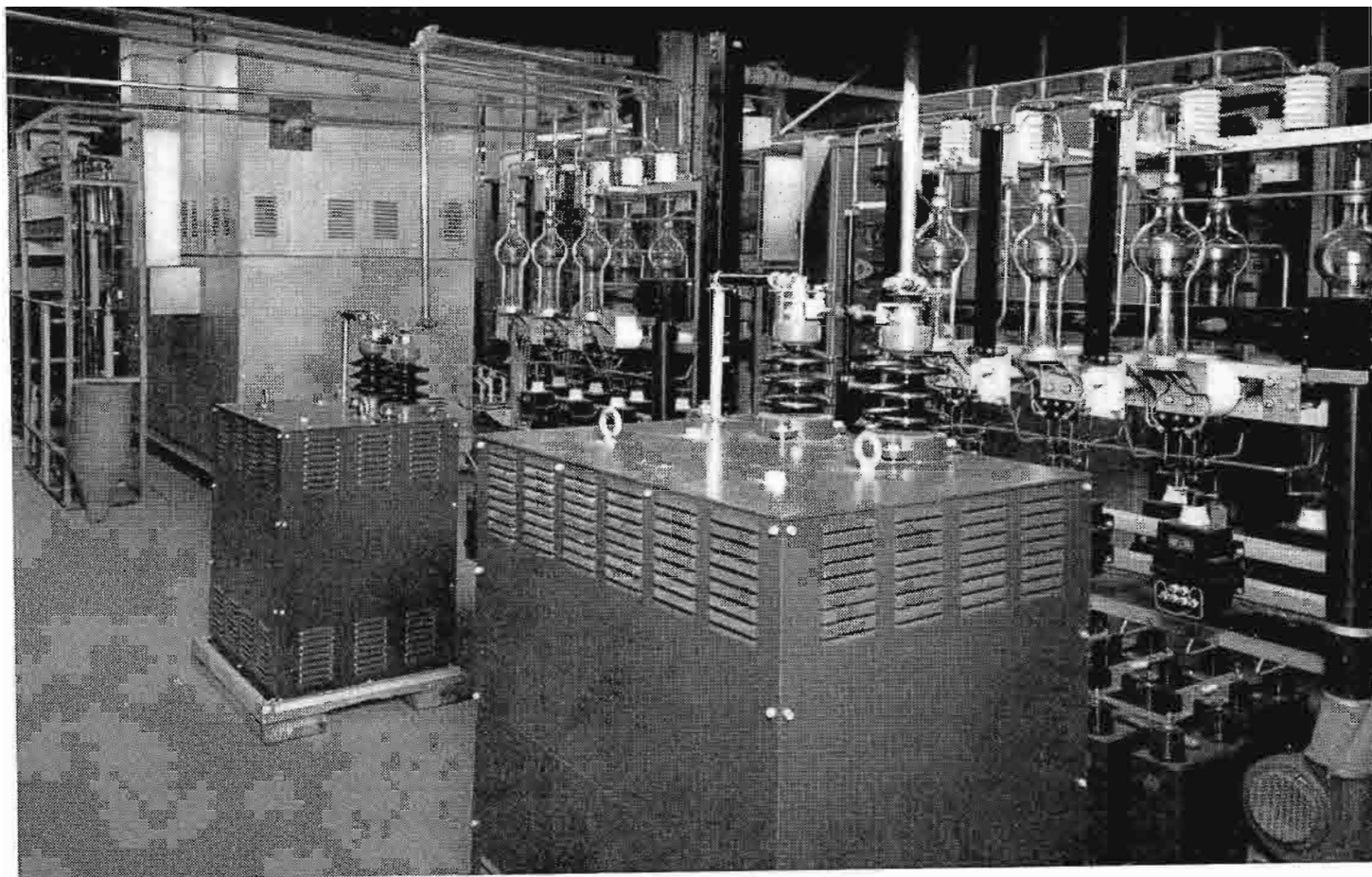
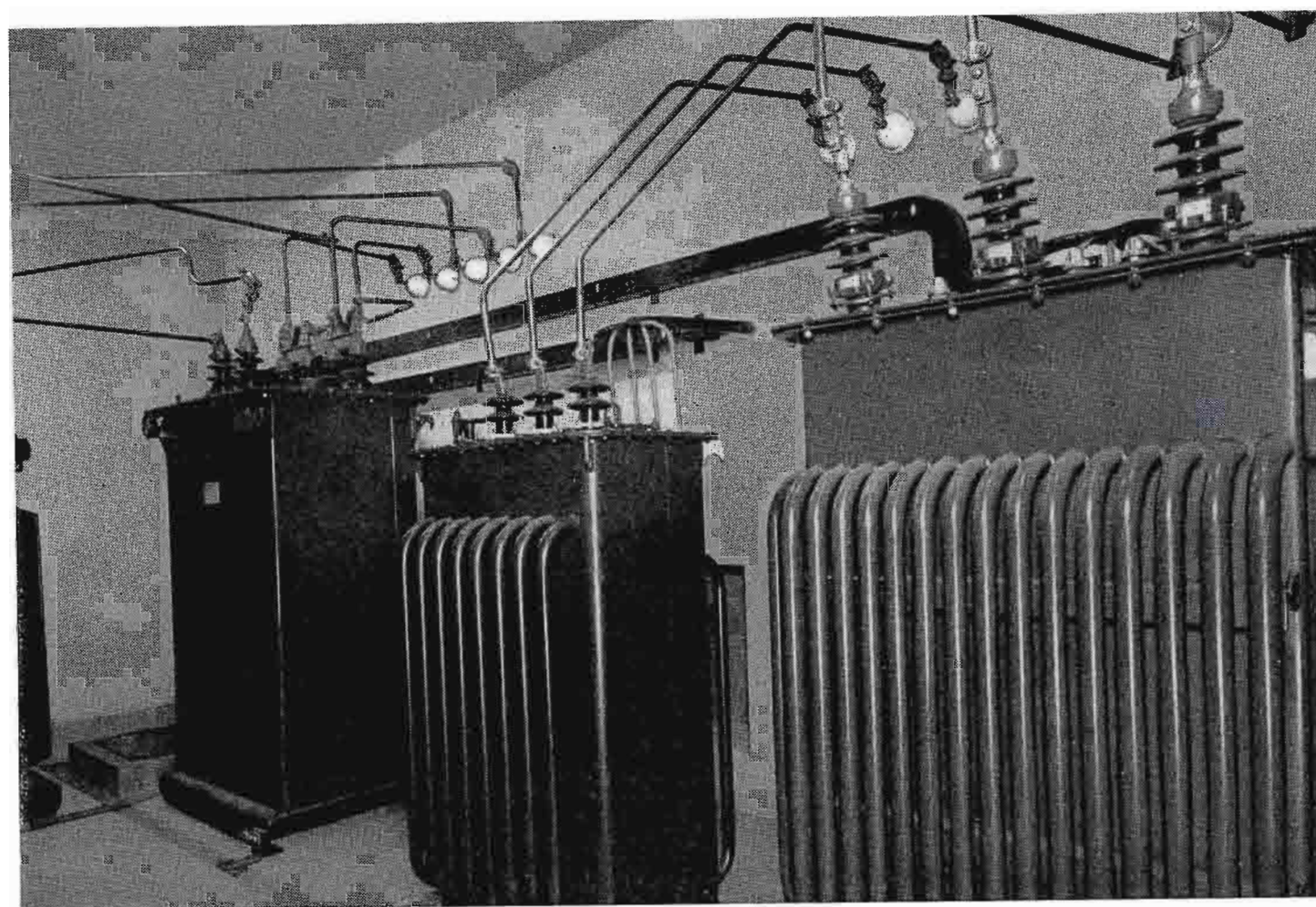

FIG. 11 (above). View of the 11.5 KV and 14 KV rectifier assemblies with associated filter reactors also visible.

FIG. 12 (below). The modulation transformer and reactor are visible at left, and the 11.5 KV and 14 KV rectifier transformers at right.



reduction is approximately 13 db. Double quarter phasing leaves only components of eight times the power frequency or higher and effects a further reduction of approximately 6 db. A total of 19 db is not actually realizable because of other factors but experience has indicated that this system will provide at least 15 db reduction of the hum produced by the magnetron effect.

Modulator circuit design was an extension of principles learned in the application of an economical system used since 1941 on 50 kilowatt transmitters. Amplifiers are push-pull throughout the chain. Low power circuits consist of a two stage voltage amplifier and includes networks

which maintain phase relations suitable for the application of feedback. The voltage amplifier is followed by a zero voltage gain, cathode follower amplifier which drives the modulator grids directly from voltage developed across the cathode networks. It will be seen that peak plate current of the cathode follower stage will be approximately the same as peak grid current in the modulator tubes. The proper choice of modulation transformer ratio and modulator d-c plate voltage provides adequate output for modulating the power amplifier even though the cathode follower driver has relatively low power output. Modulator efficiency is approximately 55% at 100% modulation. Feedback is applied from the

modulator plates to the grids of the input voltage amplifier through a resistor-capacitor network having zero phase shift at frequencies many times the highest modulating frequency. A stabilizing rectifier is provided between modulator grids and cathodes. This rectifier acts to prevent spurious oscillations which might otherwise develop when modulator grid current swings negative during a portion of the audio frequency cycle. Spurious oscillations of small magnitude may still appear due to shock excitation by steep program wave fronts. These oscillations do not affect modulator efficiency and the voltage at the spurious frequencies is attenuated to a negligible value by the "L" section network between the modulation transformer secondary and the power amplifier. The network also acts to maintain constant modulator output impedance up to 10,000 cycles per second above which the impedance rises rapidly.

Modulator tubes have individual cathode current ammeters and over current relays for indication and protection similar to those provided in the power amplifier. Each pair of modulator tubes have filaments excited in quarter phase relation to provide a hum reduction of a theoretical

13 db. Actual hum reduction in this case is approximately 10 db. The hum is further reduced by the feed-back circuit. A single phase full wave rectifier in the modulator provides fixed bias for the cathode follower and modulator tubes. Differential control on a bias bleeder network provides means for balancing the modulator static plate currents at a value of 150 milliamperes per tube. A three-phase full-wave rectifier with a half voltage tap supplies plate voltage to all low power tubes in both the radio frequency and audio frequency amplifiers.

Control relays and contactors for all circuits are centralized in so far as possible in a single unit at the right end of the transmitter. This unit includes all over current relays and sequence relays required for proper starting and protection of circuits and tubes. A reclosing relay provides for three successive re-applications of power at spaced intervals when overload faults occur. If the overload persists after the third re-application of power, the relay will automatically lock out the closing circuit to prevent further re-applications of power unless manually reset by the transmitter operator. Control switches may be set up for complete automatic starting but

switches are so arranged that the starting sequence can be interrupted manually at any of several points. Controls are distributed along the front panel of the transmitter at pertinent locations and are also duplicated on the centralized control unit. Circuits are arranged so that, if a control switch is open at any one location, power cannot be re-applied except by closing the control switch at that location. The usual safety features such as access door interlocks and high voltage grounding contactors are tied in with the control system to provide personnel protection. Water flow interlocks are provided in the return line of each separate water circuit. These interlocks are of the indicating type so that a reduction in flow can be noted before flow drops low enough to open the interlock contact. Indicating water temperature interlocks are also provided on the discharge side of each separate water circuit.

A supervisory console duplicates essential transmitter controls and indicator lights. The console also has the necessary switching and metering for control of program level and transfer to local microphone or transcription turn-table when required. A monitor rectifier to be located at the radiator tuning house provides an audio monitoring signal and also serves to shut off carrier through an auxiliary control relay when lightning causes antenna flash overs. The rectifier also provides a remote antenna current indication on the front panel of the transmitter.

Rectifier circuits which supply the power amplifier and the modulator are shown in Fig. 5. A spare tube (with filament energized) may be switched in quickly in case of failure of an active tube. High-power switch gear and distribution circuits of the transmitter include auxiliary distribution breakers which are located in the control unit at the right of the transmitter. The incoming breaker, the main rectifier breaker and the delta-wye switch are located in a separate cubicle which may be placed near the main rectifier transformer to simplify heavy current interconnections. The delta-wye switch provides a convenient means for obtaining 0.57 times the normal anode voltage for initial adjustments and tests. Probable telephone line interference due to harmonics generated in the main rectifiers is reduced by connecting the high voltage side of the 11.5 kilovolt rectifier transformer delta while the high voltage side of the 14 kilovolt rectifier transformer is wye connected.

The incoming breaker has time delay over current protection through an aux-

FIGS. 13, 14 and 15 (below). Performance curves plotted from typical test floor data compare measured curves to specification limits.

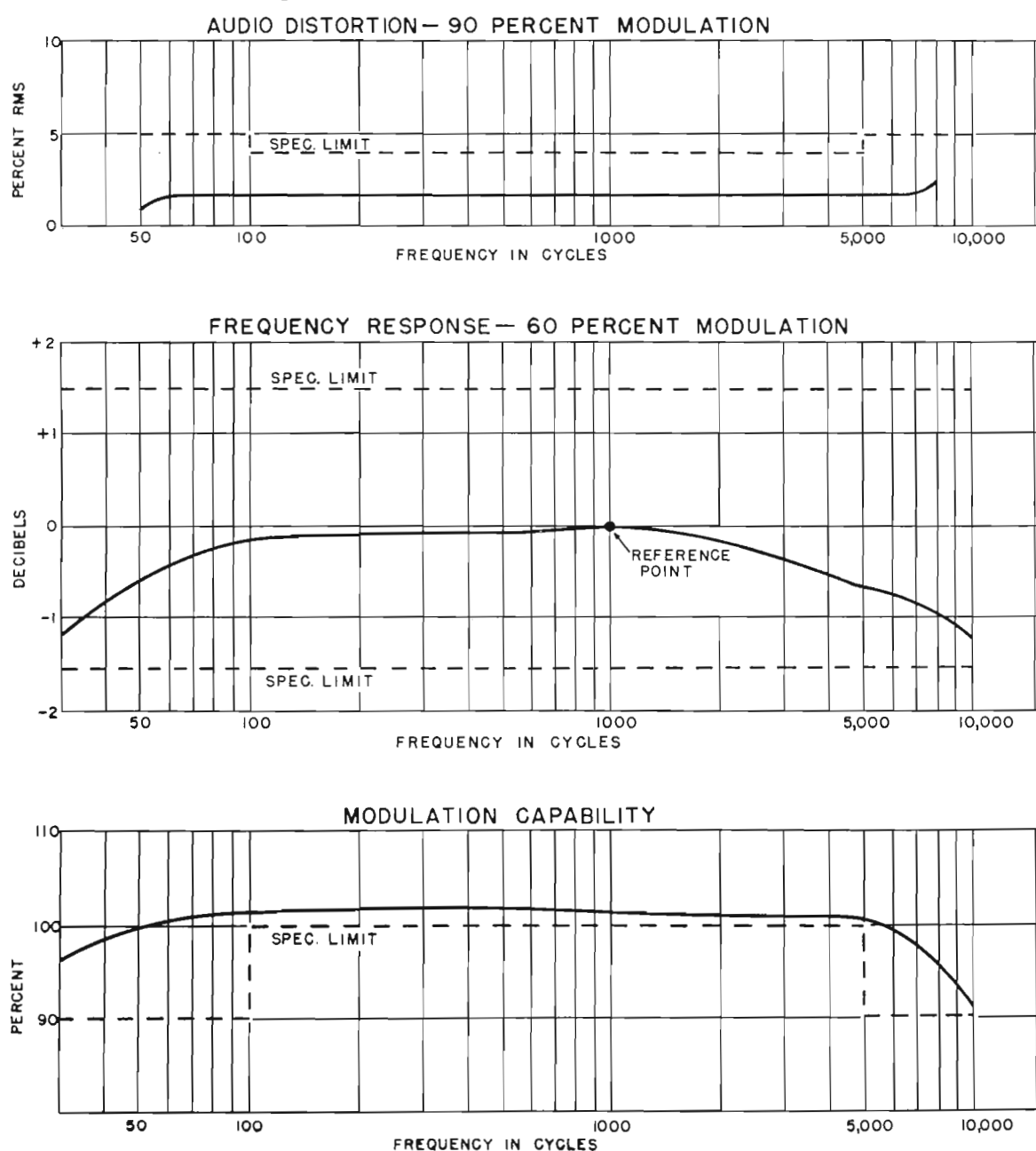

iliary induction type relay which can be adjusted so that the breaker will not open on a fault unless all succeeding breakers have failed to open. Time delay adjustment of this breaker is effective up to ten times normal current rating above which the breaker will open instantaneously. The breaker feeding the high power rectifier transformers is tripped by an auxiliary induction type over current relay which has adjustable settings for both inverse time and instantaneous operation. All other breakers in the distribution system are provided with dash pot or thermo-element inverse time protection as well as instantaneous tripping at 8 to 10 times normal rating.

A 1:1 ratio, 200 kva transformer provides the impedance necessary to use breakers of moderate interrupting rating in the secondary distribution circuit. This transformer is also equipped with taps so that the transmitter can be operated from a 380 volt power supply without changing taps or ratings on any transmitter elements in the secondary distribution system. Two single phase automatic voltage regulators (connected open delta) regulate the filament supply to high power tubes to within 1.5 per cent. A 75 kva special transformer provides the 45 degree phase shift required by the double quarter phasing, filament excitation scheme described previously. Four "T" connected transformer pairs provide the second step for quarter phasing.

Water cooling is provided by a closed system including a distilled water storage tank, two pumps in parallel and two coolers in parallel. Valves are provided so that pumps and coolers may be cut in or out without interrupting transmitter operation. Coolers are the unit air conditioning type for water to air heat exchange. Additional valves in the power amplifier, last intermediate amplifier and modulator allow isolation of any two 9C21 tubes without shutting down the complete water system to change a tube.

Figs. 1, 2, and 7 to 12 inclusive are photographs of the final product as set up for test at the manufacturing plant. The general arrangement of various units on the test floor was carried out as near as possible in accordance with recommended final installation plans so that any peculiarities introduced by discreet connector lengths could be noted and corrected prior to final installation.

### Performance

Figs. 13, 14, and 15 show typical test floor performance data at 640 kc compared directly to performance specifications. It

will be noted that an ample margin exists in all cases to cover variations which might be encountered in field installations.

### Installation

Installation details were worked out carefully so that the ultimate user would find installation easy. Terminal locations are arranged so that interconnections between units can be made with standard overhead wire ducts. High voltage bus work required at the installation site is limited to a minimum of straight runs and bends in either the two floor or single floor layout. It is possible to install this transmitter within an existing building with a minimum amount of building modification. An installation material kit provides all bus work items, wire, insulators, water piping, valves, hardware and special tools required for installation with either the single floor or two floor layout.

### Conclusions

A highly efficient, compact 150 kilowatt transmitter has been developed for medium frequency broadcast service. Excellent performance can be obtained and maintained economically without employing highly skilled operating personnel. Component and tube ratings are such that the transmitter will provide adequate trouble free service for a long period at minimum cost.

The design principles embodied in the 150 Kilowatt Transmitter can be extended to higher powers if and when required.

### Acknowledgments

Engineers who contributed to the design were J. C. Walter and staff on the overall system, N. J. Oman on audio frequency circuits and T. N. Newman on mechanical features.

FIG. 16 (at right). Curve of 150 KW transmitter power input vs. modulation percent compared to specification limits.

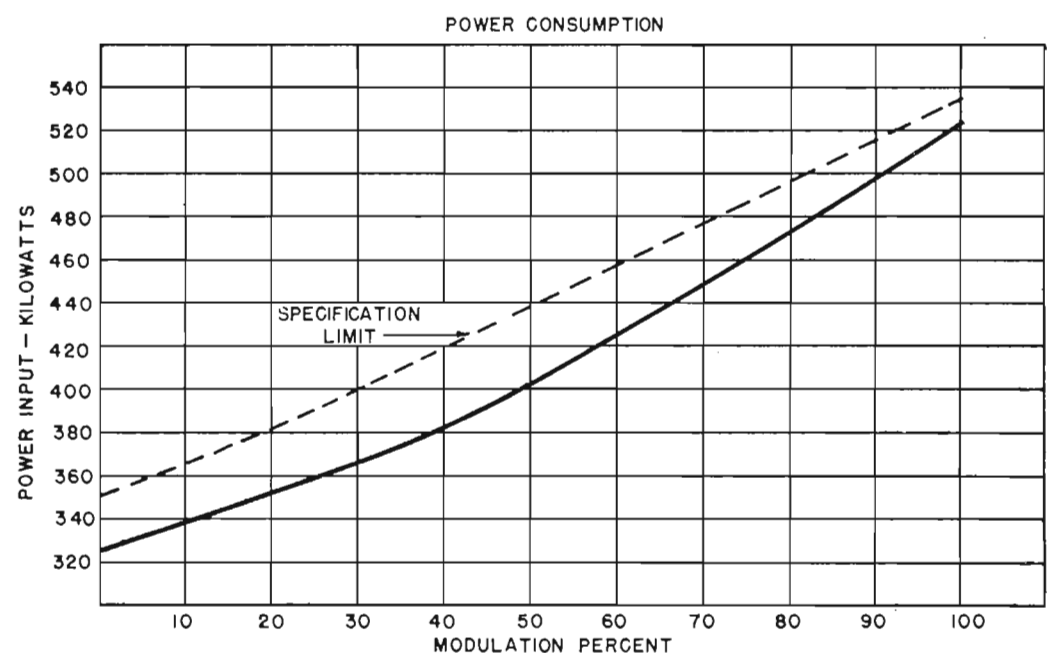

PERFORMANCE SPECIFICATIONS		
	Specification	Actual
FREQUENCY RANGE	Any specific frequency in the band from 540 to 1600 kilocycles	535 to 1605 kcs
POWER OUTPUT	150 KW unmodulated carrier power at transmitter output terminals	155 KW within other specification limits
FREQUENCY STABILITY	Plus or minus 10 cycles per second	Not measured. Identical frequency source previously measured well within specification limits.
CARRIER SHIFT	Less than 5 per cent at any modulation percentage up to 95 per cent	1.5 per cent positive at 100 per cent modulation
NOISE LEVEL	Less than 56 db RMS below 1000 cps. 100 per cent modulation	57 db
RADIO FREQUENCY HARMONICS	70 db below fundamental measured at 1 mile	Not measured. Circuits are included to meet specification requirements
PROGRAM INPUT LEVEL	Plus 10 vu plus or minus 2 vu for 100 per cent modulation at 1000 cps.	Plus 9 vu

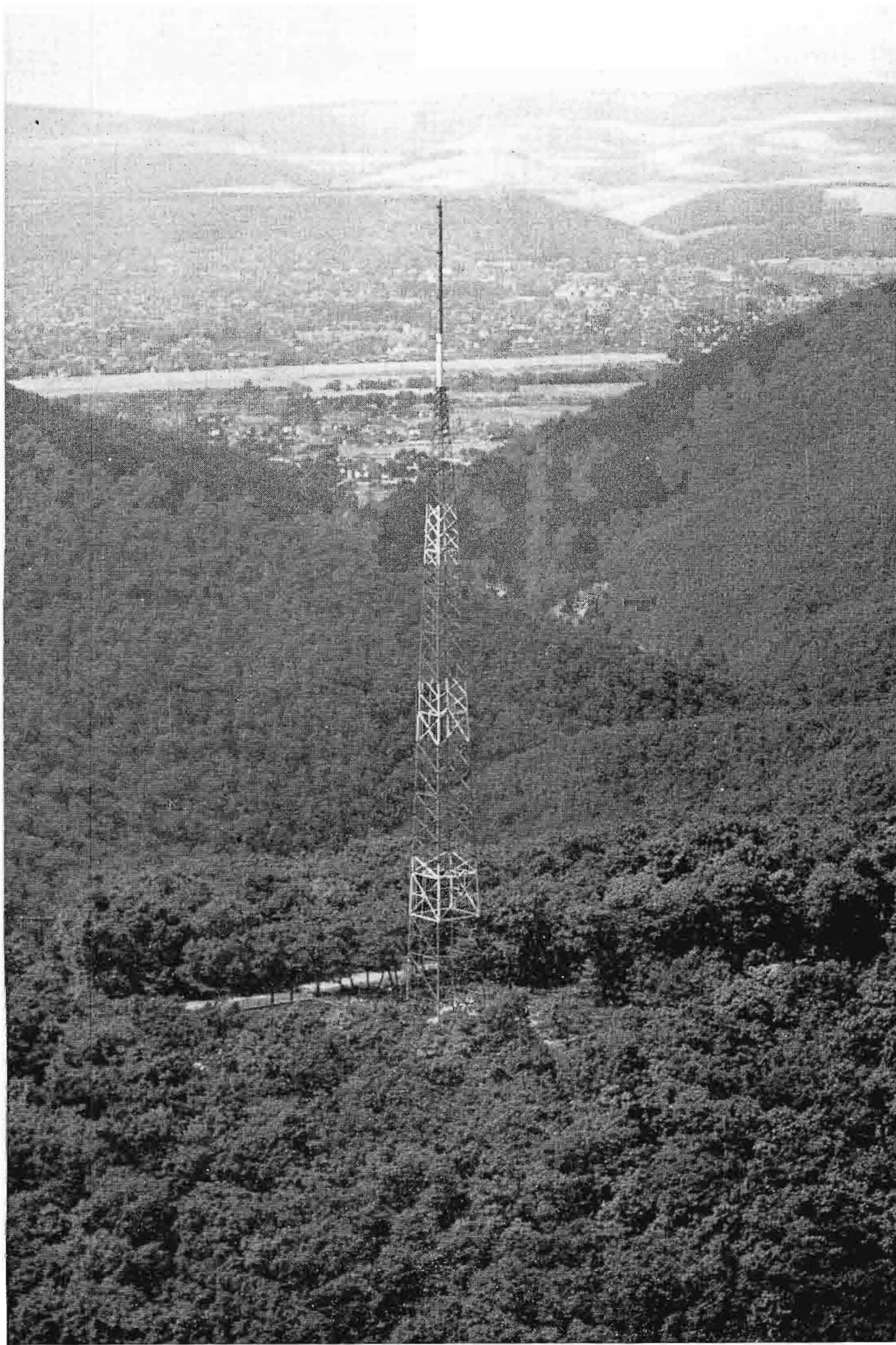

FIG. 1 (left). WRAK-FM's four-section Pylon is located on a 2200 foot mountain ridge overlooking Williamsport (background) and the surrounding countryside.

in the fall of 1947. A site was secured for the antenna and transmitter housing atop Bald Eagle Mountain, North White Deer Ridge Road, approximately 7 miles due south of Williamsport. The location is 2170 feet above sea level, with an average effective height of 1287 feet above the terrain. The RCA four-section FM Pylon Antenna is mounted atop a Blaw-Knox 200-foot steel tower, giving an overall height of approximately 2415 feet above sea level.

Ground was broken for the transmitter building soon after work started on the antenna tower. The building is designed to provide the optimum in fireproofing. The floor plan not only allows room for easy access to all equipment, but leaves plenty of room to spare for any equipment that may be added in the future. The heating system is a fully automatic oil burner, supplying hot water for heating, as well as domestic use. Emergency power in case of power failures is obtained from a 10 KW gas-driven generator.

The transmitter at WRAK-FM is an RCA 1 KW FM, Type BTF-1C Transmitter. Assembly started early in 1948, and due to the absence of trouble experienced in this installation, the work was completed and equipment tests were made in a very short period of time. Everything proceeded smoothly without hitch from the time the first switch was thrown. The transmitter is operated with an output of 610 watts, providing 3.2 KW of effective radiated power from the four-section Pylon antenna.

Just short of a year after receiving the construction permit, WRAK-FM went on the air officially. The original programming provided a full schedule of operation between the hours of 3 p.m. and 9 p.m., serving the north central Pennsylvania area. The 1000 microvolt contour, with an average radius of 22.9 miles, covers an area with a population of almost 200,000 people. The land area of 11,675 square miles reached within the 50 microvolt contour gives advertisers a potential listening audience of 1,504,870.

The main studios for the FM station are located in the same building as that which houses the AM studios. By converting some of the original studios, the space was utilized to give plenty of room for both stations so they could operate inde-

# WRAK-FM WILLIAMSPORT, PA.

## Mountain-Top Transmitter Serves An Area Of 11,665 Square Miles With 3.2 KW (ERP)

In the Spring of 1947, WRAK Inc., located in the Sun-Gazette Building, Williamsport, Pa., was granted a Construction Permit from the Federal Communications

Commission. Less than a year later WRAK-FM was on the air.

Actual construction, delayed several months by a scarcity of materials, started

**FIG. 2. (right).** WRAK-FM transmitter is located in a modern-type brick building close to the base of the 200-foot tower which supports the Pylon.

pendently. The FM studio control room is equipped with an RCA Type 76-B4 Console and two RCA Type 70-D Transcription Turntables. All programs produced in the studios are sent to the transmitter over open wire transmission lines. To date, very little trouble has been experienced with this type of feed to the transmitter, and the engineers at WRAK prefer it to link coupling.

For the first six months, WRAK-FM operated without depending upon WRAK for programs, but in the fall, the use of dual operation, which had been under consideration for some time, came into being. Such operation was incorporated with a two-fold purpose; WRAK, being an affiliate with NBC, would provide WRAK-FM with much better programming, and, in turn, the FM station could reach many people who were unable to receive WRAK during night hours, thus giving full NBC coverage. At the present time, the two stations operate simultaneously from 7 a.m. to 12 midnight, daily.

**FIG. 3 (below).** WRAK-FM's RCA transmitter and associated line and monitoring equipment are arranged primarily for convenience and accessibility.

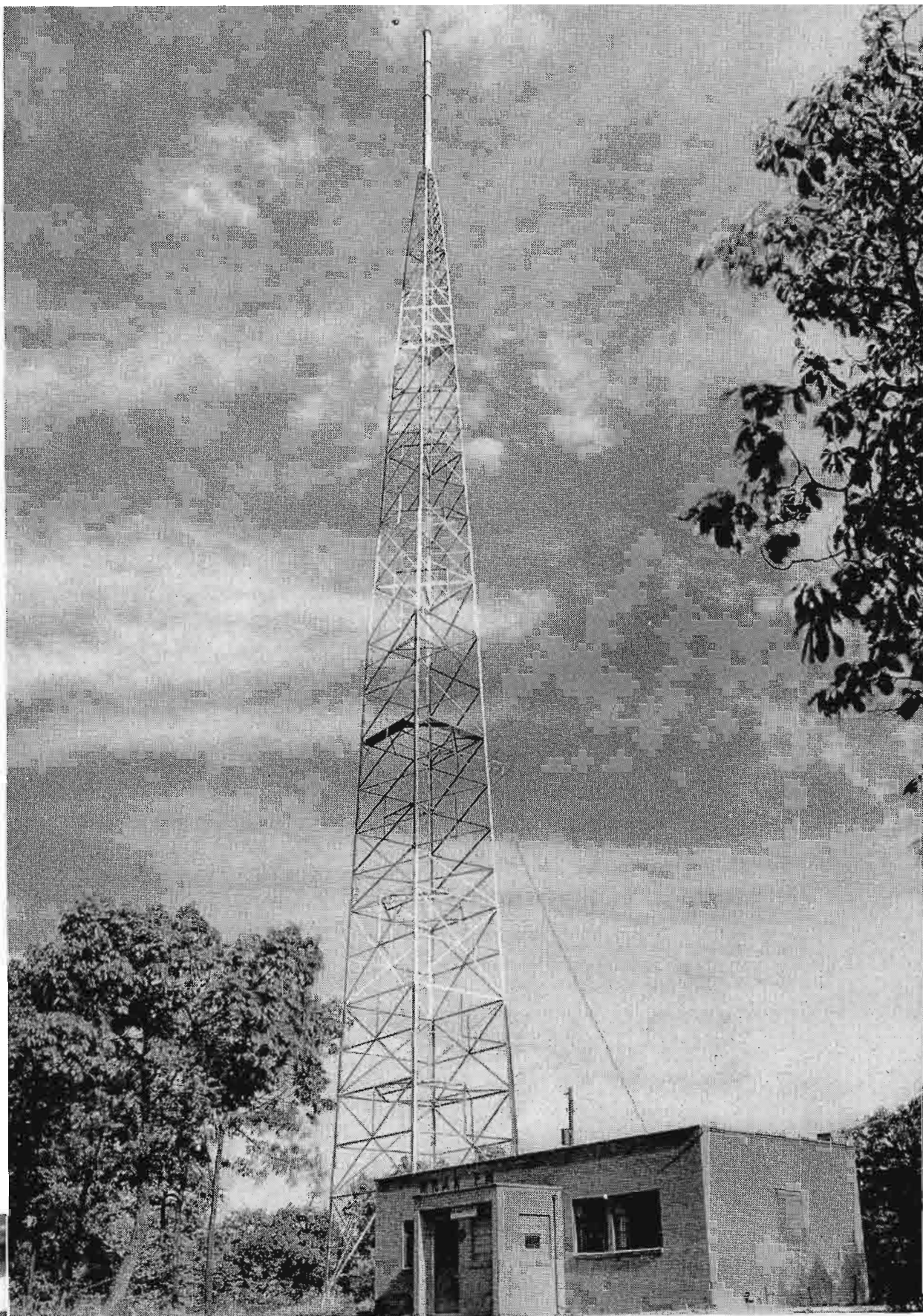

# OSCILLOSCOPES AND VACUUM TUBE VOLTMETERS

## HOW THEY READ AND WHAT THEY DO

by **GEORGE E. REILING** and **PAUL A. GREENMEYER**

RCA Victor Division

Because of the wide range of frequencies, as well as the great variety of waveforms, encountered in modern electronic devices, many different types of oscilloscopes and vacuum tube voltmeters have been developed. These have widely varying characteristics. Each is designed for a specific class of uses; and when employed outside this class it usually exhibits severe limitations. Effective use of these two instruments can lead to a large degree of efficiency in both production and operation of radio, television, and other electronic equipment.

In order to make measurements rapidly yet accurately, the proper type of instrument must be chosen. The user must know which oscilloscope to choose for making measurements in a video frequency amplifier and which to choose for testing an audio amplifier. In some cases the more-expensive high-frequency oscilloscope is

not required since a less-expensive low-frequency oscilloscope serves the same purpose. Similar considerations apply to VTVM's.

### Nature of the Instruments

In essence, an oscilloscope consists of a cathode-ray tube plus a power supply. For practical applications, the oscilloscope must include amplifiers for obtaining horizontal (X) deflection, vertical (Y) deflection, and intensity (Z) modulation. Amplifiers are selected from the viewpoint of the end use for which the oscilloscope is designed. For example, for work in a narrow band of frequencies the choice of wide bandwidth amplifiers constitutes unjustifiable expense. As a result, there are a number of designs, each for a specific category of applications, with wide variation in the characteristics of the individual oscilloscopes.

Basically, the vacuum tube voltmeter consists of a vacuum tube amplifier and a d-c meter. For practical applications, a balancing circuit must be incorporated in order to have stability of operation. The instrument may be cheapened by use of a

single-tube balancing circuit instead of a two-tube circuit; however, the economy thus effected is questionable since it leaves the instrument susceptible to line voltage variations. In all such design considerations, the requirements of the user as to stability, voltage, impedance, frequency, etc., are the determining factors. These requirements have been found to fall into three general classifications, therefore, four different VoltOhmysts have been produced.

### Types of Oscilloscopes

Three RCA oscilloscopes have been produced to cover radio, television, and industrial applications. The Type 715-B is a wide-bandwidth, laboratory-type, primarily designed for research and general use in television stations and in laboratories. Its range extends to 11 mc; deflection sensitivity is 0.06 rms. volts per inch; sweep rate may be periodic or aperiodic; and it has microsecond time base markers. The 715-B permits close examination of extremely short, sharp-fronted pulses, and other unusual waveforms. High-speed transients are faithfully reproduced. A high accelerating voltage produces an intense spot suitable for short pulses with low repetition rates. A peak-to-peak a-c voltmeter is built-in for checking signal amplitudes.

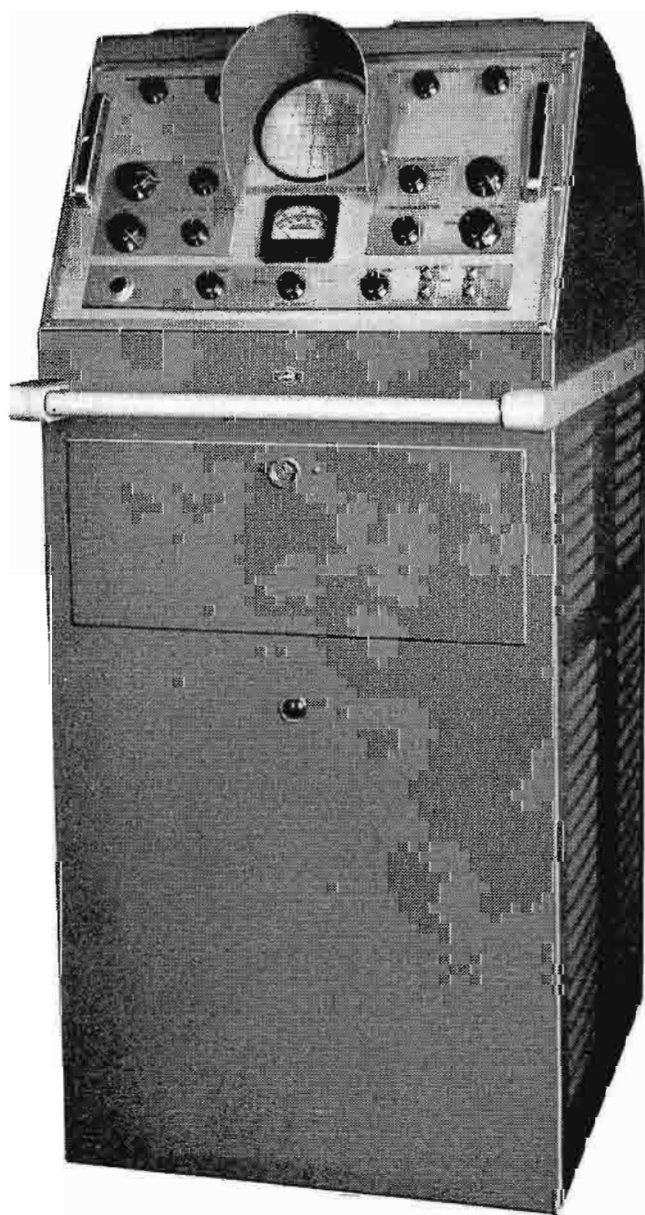

Type 715-B Oscilloscope



Type WO-79A Oscilloscope

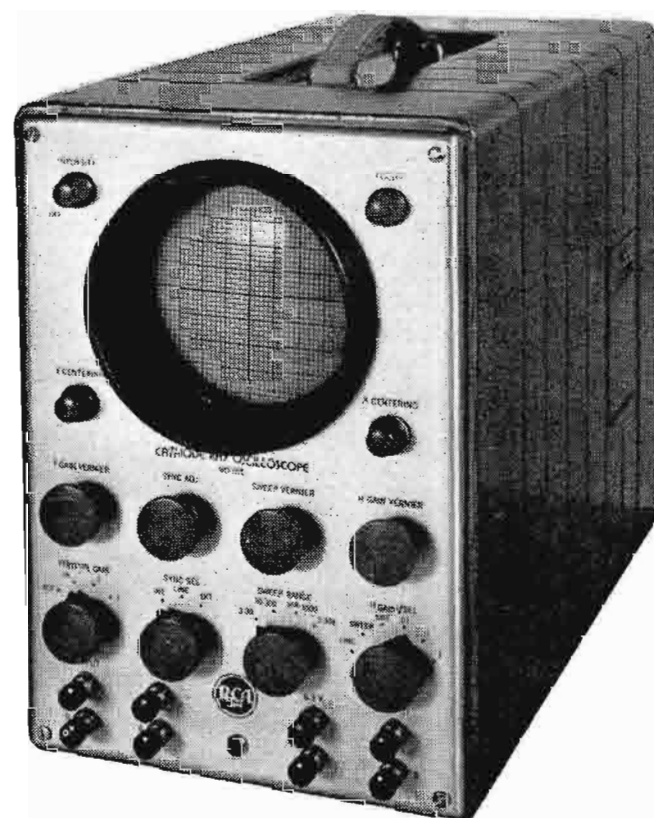

Type WO-60C Oscilloscope

The WO-79A is a portable version of the laboratory type. It incorporates the features of wide bandwidth (up to 5 mc) and triggered sweep. Together with sweep expansion and internal time delay, this makes the WO-79A useful for observation of television, radar, and other high-frequency pulses. A peak-to-peak a-c meter is also incorporated for checking signal amplitudes. For station maintenance and for television field operations, this oscilloscope is in great demand.

The Type WO-60C is a comparatively low-frequency instrument (flat from 2 cycles to 100 kc, useful from 1/2 cycle to 300 kc) with identical horizontal and vertical amplifiers. Special amplifier circuits are included to give better-than-usual sensitivity (0.020 rms. volts per inch). Designed for general purpose applications, this oscilloscope is especially suitable for making audio amplifier adjustments, for example, locating and eliminating distortion. Its exceptional low-frequency response makes it suitable for measuring mechanical movements of cams or machinery, for vibration tests, and for industrial electronic maintenance. Measuring of phase shift characteristics is a particularly suitable application for this instrument because its amplifiers have identical phase shift characteristics. A new design feature makes it possible to change c-r tubes in about 10 seconds—without removing the instrument from its case. This permits rapid changeover from medium to high or low persistence screen c-r tubes.

#### Types of VoltOhmysts

Three VoltOhmysts have been developed to fulfill all requirements; the Senior, Type 195-A; the newer High-Frequency Volt-

Ohmyst, Type WV-75A; and the Battery VoltOhmyst, Type WV-65A. The 195-A is designed for general use. It embodies all the inherent advantages of electronic measuring circuits, namely, (a) ability to measure accurately because the circuit is not loaded, (b) ability to measure under operating conditions, (c) ability to measure high values of resistance, and (d) protection against meter burnout. The 195-A measures a-c and d-c to 1000 volts, and resistance to 100 megohms. Audio frequency voltages may be measured up to 100 volts with flat response from 30 cycles to 100 kc. As an output indicator, this VoltOhmyst reads directly in either db or volume units. Zero setting at center scale makes it useful for aligning monitors, etc.

The Battery VoltOhmyst, Type WV-65A, is designed for use in the field or any other place where a power outlet is not

available. It measures a-c and d-c to 1000 volts; resistance to 1000 megohms. In addition, it reads d-c current to 10 amperes. A small neon lamp flashes when the power is on. The instrument incorporates all the features of its predecessors.

The reading obtained through use of these standard VoltOhmysts is proportional to the positive peak of the applied a-c voltage. The meter indicates approximately 0.707 times the positive peak value (rms of sinusoidal voltage). Thus the positive peak value may be determined by multiplying the meter reading by 1.414. These instruments, in common with practically all vacuum tube voltmeters read positive peaks (or pulses) only.

Prior to the advent of television, the vacuum tube voltmeter designed for sine wave measurements was found adequate

Type WV-95A  
Master VoltOhmyst

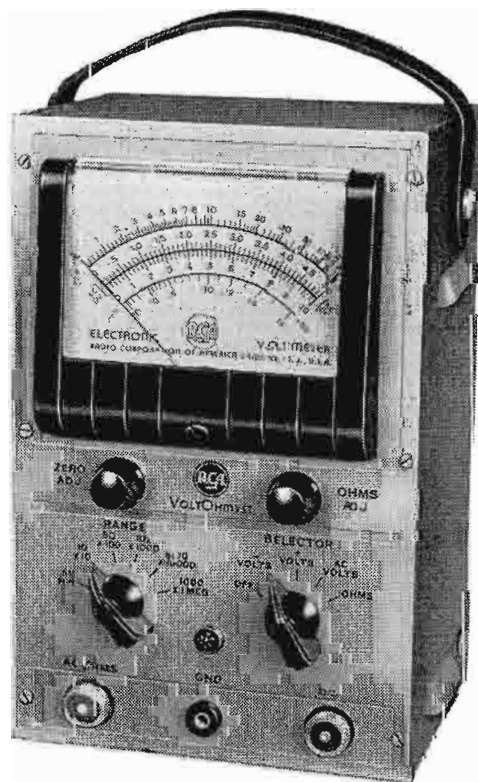

Type 195-A VoltOhmyst



Type WV-65A  
Battery VoltOhmyst

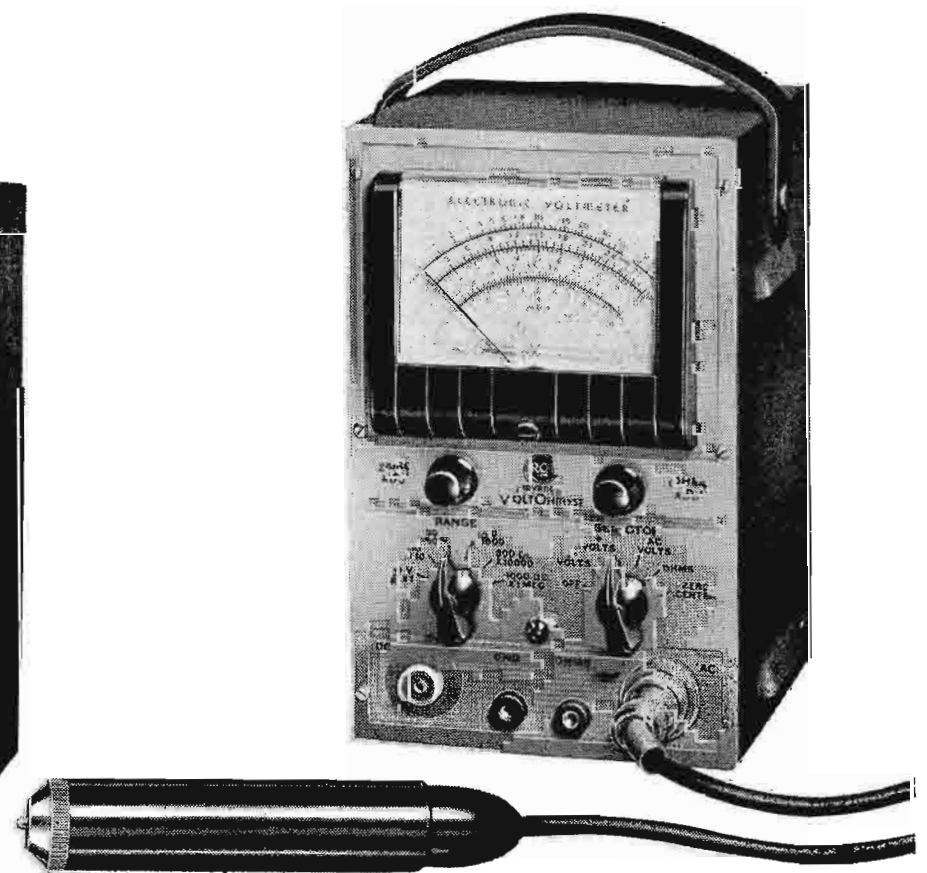

Type WV-75A High Frequency VoltOhmyst

for most requirements. With the introduction of pulsed circuits, however, it was necessary to calculate qualitative information when using sine wave equipment. This handicap has been overcome with the introduction of the High-Frequency Volt-Ohmyst, Type WV-75A. The instrument incorporates a full-wave diode rectifier in a probe, therefore, it measures proportional to the peak-to-peak voltages. In addition, the frequency range has been extended up to 250 mc, which is more than adequate for the majority of applications. The WV-75A measures a-c and d-c to 1000 volts; resistance to 1000 megohms. Zero setting at center scale makes it useful for aligning monitors, etc. It embodies all features of electronic measuring circuits.

The Master VoltOhmyst, Type WV-95A, is a deluxe type universal measuring instrument designed especially for television servicing. It is mounted in one of the new-type standard instrument cases so that it

matches other new RCA service units in appearance and size and can be conveniently mounted in the standard RCA service bench. The WV-95A VoltOhmyst incorporates a full-wave diode rectifier similar to that in the WV-75A. In addition it is provided with facilities for measuring capacity and d-c current.

#### Crystal Probe for VoltOhmysts

In modern electronic equipment, even those circuits customarily spoken of as "low frequency" are fast approaching the upper frequency limit of popularly priced vacuum tube voltmeters. To further increase the usefulness of the VoltOhmysts, an RCA Crystal Probe (WG-263) was introduced about a year ago. This Probe fits all models of the VoltOhmyst, including the original Senior and Junior. It may also be employed on the voltmeter channel of the RCA Radio Chanalyst or the Audio Chanalyst. The Probe converts the d-c circuit of the VoltOhmyst to read a-c, by

means of a Germanium crystal that rectifies the applied a-c. By this means r-f voltages up to 100 mc may be measured.

#### Typical Applications and Limitations

In order to show the particular application of each type of oscilloscope and VTVM a series of tests using various types of these instruments are presented herewith. These are designed to illustrate general principles and their application. The effect of using a low-frequency oscilloscope for amplifying high-frequency signals, and vice versa, are demonstrated. The ease with which misleading information may be obtained when using the standard VTVM for reading pulsed voltages, and the limitation on high-frequency readings is also established. Sine waves, square waves, and pulsed signals are considered in this series of tests. Pure and distorted signals are investigated. Typical video and audio tests are simulated.

## A. HOW OSCILLOSCOPES AND VT VOLTMETERS READ WHEN THE INPUT IS A DISTORTED 100 KC SINE WAVE

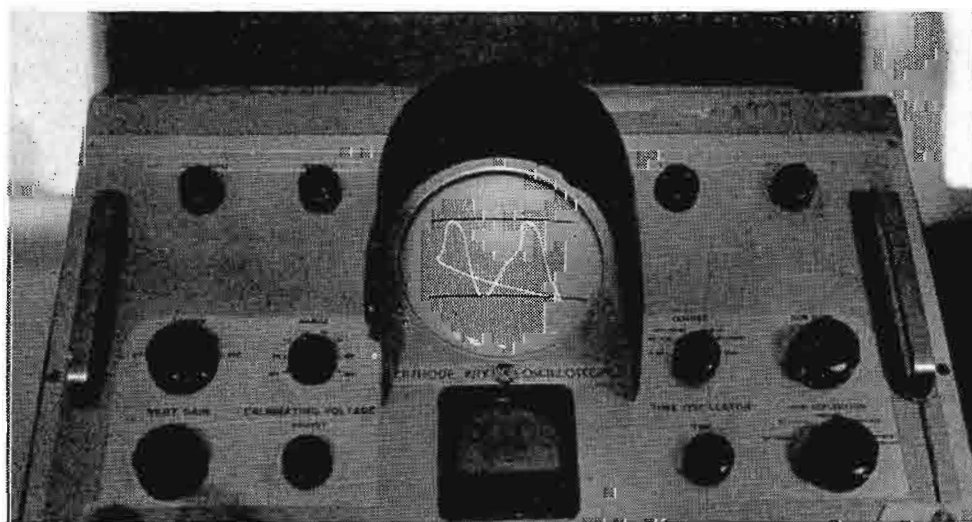

FIG. 1. Type 715-B.

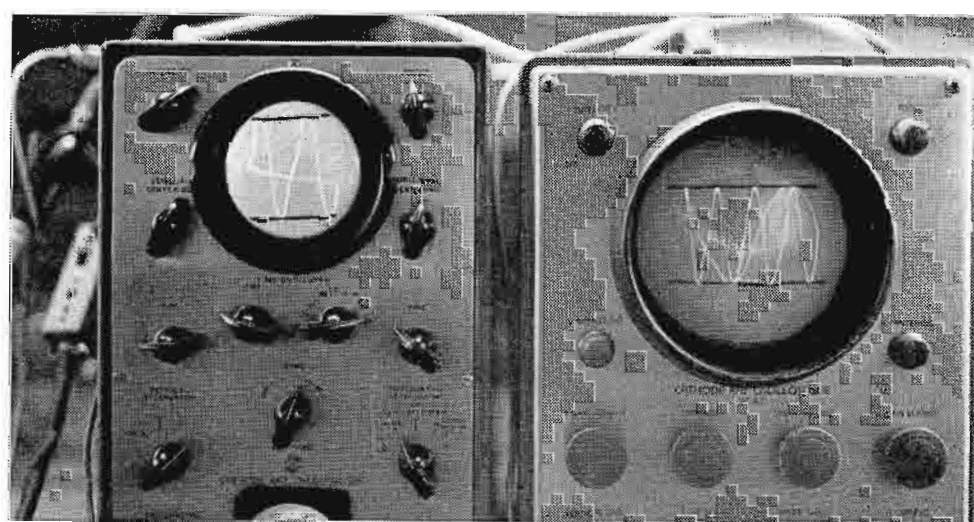

FIG. 2. (Left) Type WO-79A; (right) Type WO-60C.

**Input:** The input to the vertical amplifiers of the three oscilloscopes and to the three VoltOhmysts is a 100,000 cycle (100 kc) sine wave. Horizontal deflection in each oscilloscope is obtained from built-in sawtooth generators. In the 715-B and the WO-79A, the sawtooth frequency is set at 50 kc, hence two complete waveforms of the 100 kc signal appear on these screens. In the WO-60C, the sawtooth frequency is set at 25 kc, hence four complete waveforms appear on the screen.

**Calibration:** The oscilloscopes are calibrated at 6 volts peak-to-peak, which is indicated by the black lines marked on the cathode-ray tubes.

**Characteristics of the Input Signal:** The 100 kc signal contains appreciable harmonic distortion. This results from the second harmonic (200 kc), the third harmonic (300 kc), the fourth harmonic (400 kc), and limited higher harmonics. Consequently, the signal is unsymmetrical, i.e., the part of the trace above an

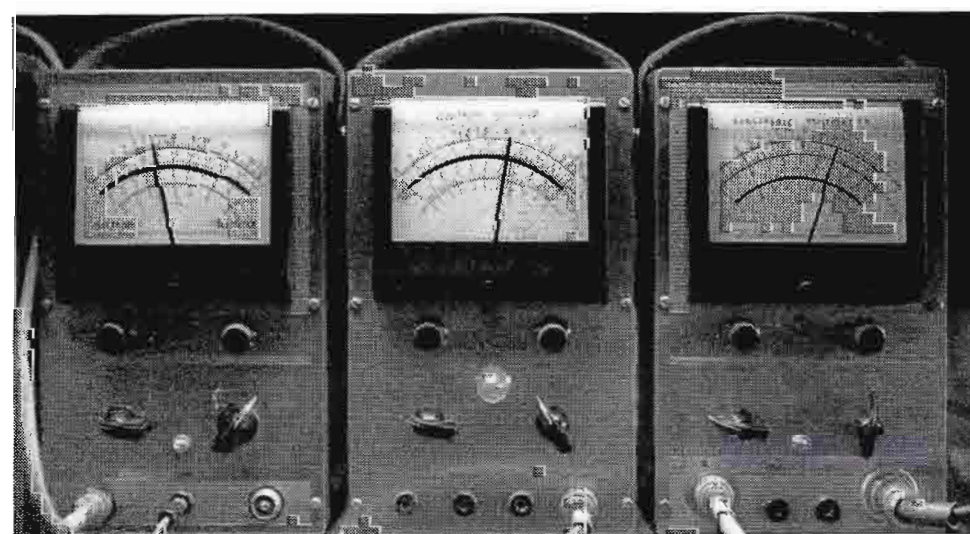

FIG. 3. Type 195-A  
1.9 volts (rms)

Type WV-65A  
(with Crystal Probe)  
1.9 volts (rms)

Type WV-75A  
2.15 volts (rms)



imaginary center line is not identical with the part below. This also means that the areas of positive and negative excursion are not equal.

**Discussion of Oscilloscope Patterns:** Oscilloscope patterns obtained with this input are shown in Fig. 1 and Fig. 2. It will be noted that the 715-B oscilloscope traces the signal to accurately picture the harmonic distortion. The wide bandwidth of the amplifiers of the 715-B reveals considerable detail as to the extent of the distortion. Since the amplifiers of this instrument exhibit a flat frequency response to 11 mc, therefore, the 715-B is capable of revealing distortion extending to the 110th harmonic of a 100 kc sine wave.

The distortion does not show up on the WO-60C (right) because the useful range of its amplifiers ends at 300 kc—the point

at which harmonic distortion of the signal is becoming appreciable. The amplifiers of the WO-79A (left) have a flat frequency response to 5 mc, therefore, it is capable of revealing details of distortion to the 50th harmonic of the 100 kc sine wave.

**Discussion of Voltmeter Readings:** Voltmeter readings obtained with this input are shown in Fig. 3. The difference in the above readings springs from two causes. First, the WV-75A reads peak-to-peak, while the others read the positive peak only. Second, there is the effect of signal dissymmetry. A clearer picture is obtained by converting the rms readings as follows:

$$1.9 \text{ volts} \times 1.41 = 2.68 \text{ volts}$$

(positive peak—the lesser in magnitude)

$$2.15 \text{ volts} \times 2.83 = 6 \text{ volts}$$

(peak-to-peak—the actual value)

## B. HOW OSCILLOSCOPES AND VT VOLTMETERS READ WHEN THE INPUT IS A 100 KC SQUARE WAVE

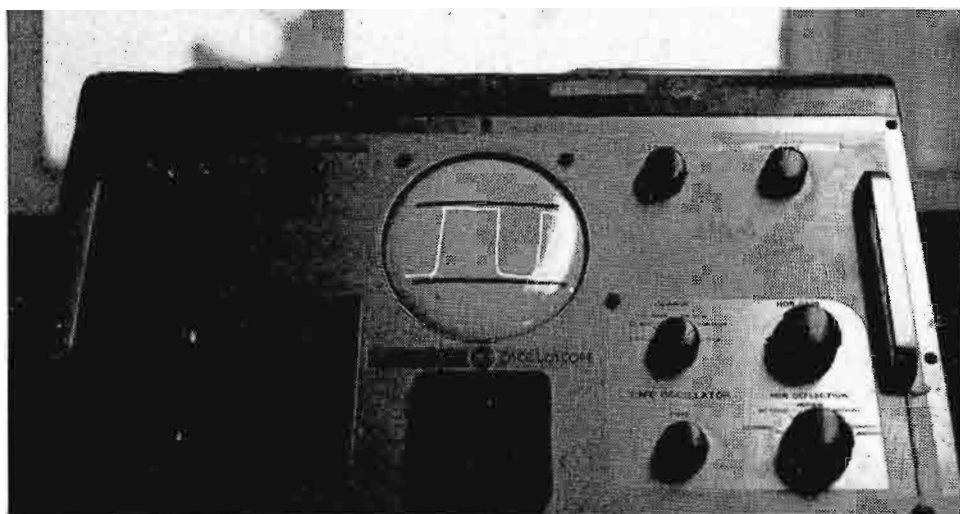

FIG. 4. Type 715-B.

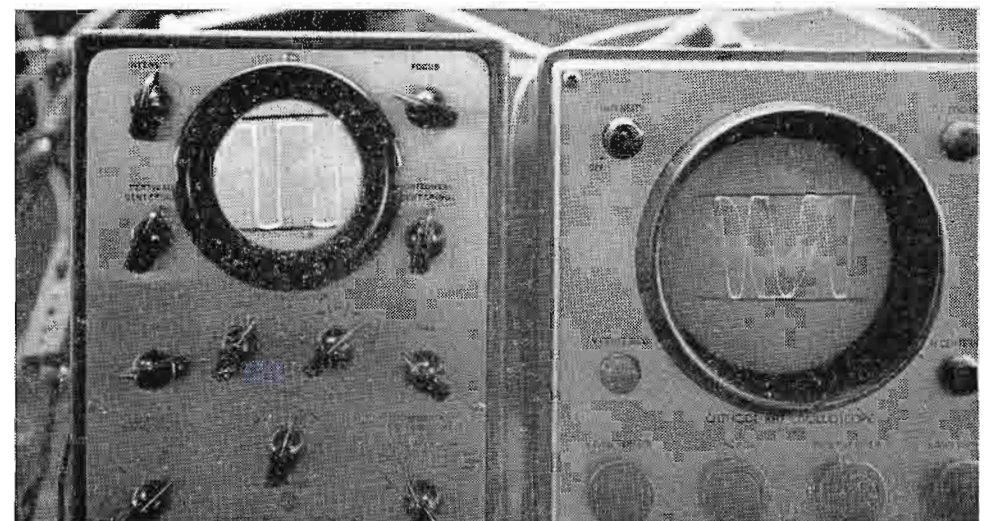

FIG. 5. (Left) Type WO-79A; (right) Type WO-60C.

**Input:** The input to the vertical amplifiers of the three oscilloscopes and to the three VoltOhmysts is a 100,000 cycle (100 kc) square wave. Horizontal deflection in each oscilloscope is obtained from built-in sawtooth generators. In the 715-B and the WO-79A oscilloscopes, the sawtooth frequency is set at 50 kc, hence two complete waveforms of the 100 kc signal appear on these screens. In the WO-60C oscilloscope, the sawtooth frequency is set at 25 kc, hence four complete waveforms appear on the screen.

**Calibration:** The oscilloscopes are calibrated at 6 volts peak-to-peak, which is indicated by the black lines marked on the cathode-ray tubes.

**Characteristics of the Input Signal:** The square wave is often used as a source for measuring response of a video frequency amplifier. Square waves contain a multitude of harmonics. The signal used in this test is not a perfect square wave. Some of the higher harmonics, which enter into the composition of square wave corners, have been attenuated in the negative excursion. As a result, the corners of the negative excursion are rounded.

**Discussion of Oscilloscope Patterns:** Oscilloscope patterns obtained with this input are shown in Fig. 4 and Fig. 5. The wide bandwidth amplifiers of the 715-B oscilloscope give a faithful reproduction of the 100 kc square wave signal. The trace shows that the signal employed is not a perfect square wave. The

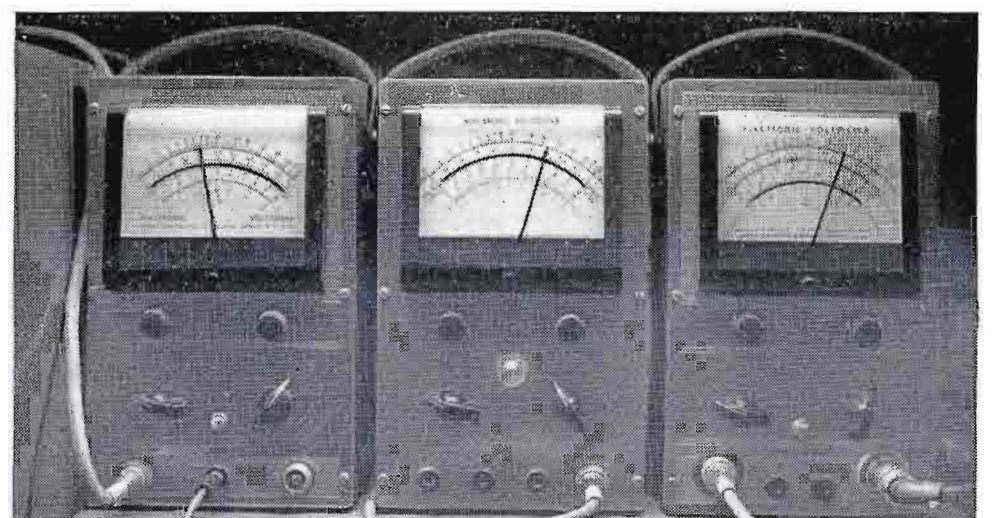

FIG. 6. Type 195-A  
2.2 volts (rms)      Type WV-65A  
(with Crystal Probe)  
2.2 volts (rms)      Type WV-75A  
2.15 volts (rms)

trace reveals quite clearly that the corners of the negative excursion are not square. The corners of the positive excursion on the other hand are seen to be square.

The trace on the WO-79A does not indicate any obvious deviation from a square wave. The trace on the WO-60C does not even approach a square wave pattern. This is because the nar-

row bandwidth amplifiers of the WO-60C attenuate the higher harmonics, such as 300 kc, 500 kc, etc., therefore, all corners appear rounded.

**Discussion of Voltmeter Readings:** Voltmeter readings obtained with this input are shown in Fig. 6. The 195-A and the WV-65A read proportional to the positive peak voltage, while the WV-75A

reads proportional to the peak-to-peak voltage. Converting the rms readings to peak voltages gives a clear picture of the results:

$$2.2 \text{ volts} \times 1.41 = 3.1 \text{ volts} \quad (\text{positive peak—the greater in magnitude})$$

$$2.15 \text{ volts} \times 2.83 = 6 \text{ volts} \quad (\text{peak-to-peak—the actual value})$$

## C. HOW OSCILLOSCOPES AND VT VOLTMETERS READ WHEN THE INPUT IS A 500 KC SINE WAVE

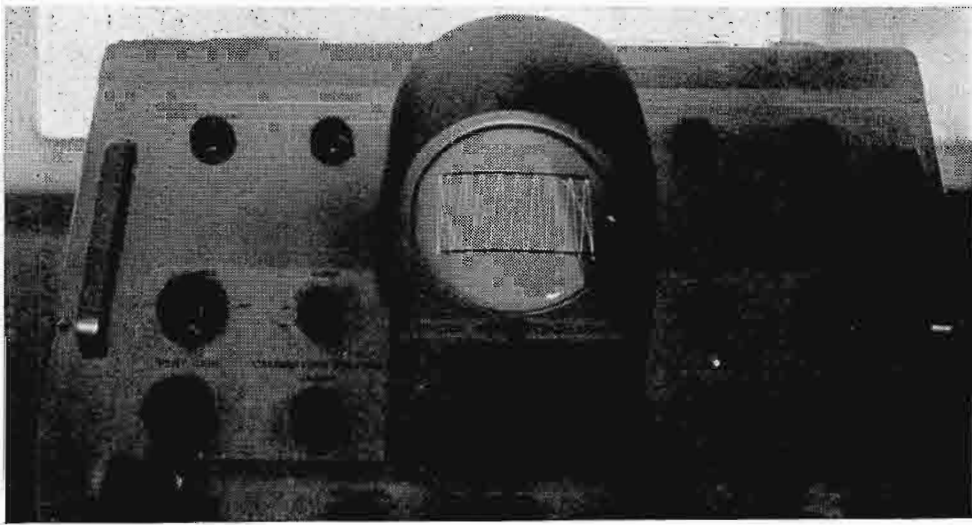

FIG. 7. Type 715-B.

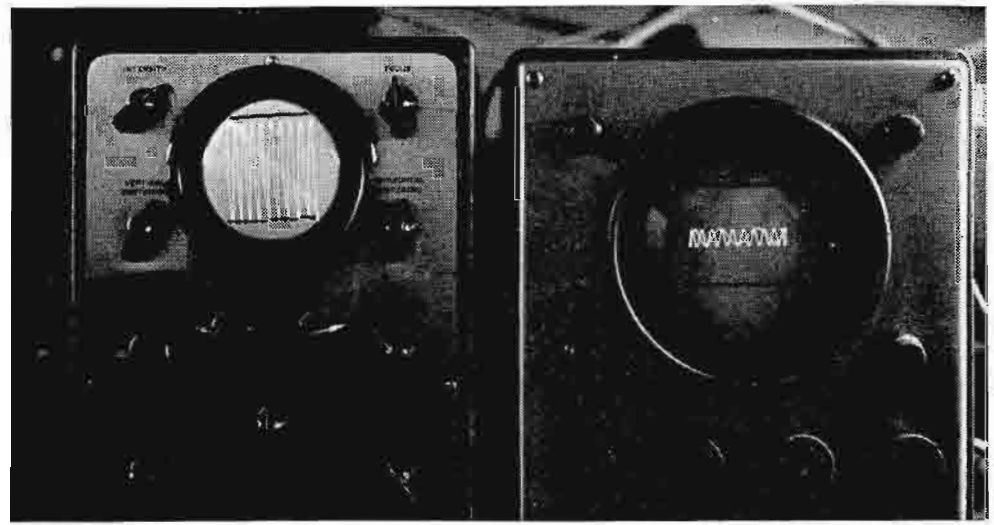

FIG. 8. (Left) Type WO-79A; (right) Type WO-60C.

**Input:** The input to the vertical amplifiers of the three oscilloscopes and to the three VoltOhmysts is a 500,000 cycle (500 kc) sine wave. Horizontal deflection in each oscilloscope is obtained from built-in sawtooth generators. In the 715-B and the WO-79A oscilloscopes, the sawtooth frequency is set at 50 kc, hence 10 complete waveforms of the 500 kc signal appear on these screens. In the WO-60C, the sawtooth frequency is set at 33 kc, hence 15 complete waveforms of the 500 kc signal appear on the screen.

**Calibration:** The oscilloscopes are calibrated at 6 volts peak-to-peak, which is indicated by the black lines appearing on the faces of the c-r tubes. The 195-A and the WV-65A VoltOhmysts read the rms value of the positive peak of a sine wave; the WV-75A VoltOhmyst reads the rms value of from peak-to-peak of a sine wave.

**Characteristics of the Input Signal:** The input signal is a practically perfect sine wave. It has no appreciable distortion. Its peak-to-peak value is exactly 6 volts.

**Discussion of Oscilloscope Patterns:** Oscilloscope patterns obtained with this input are shown in Fig. 7 and Fig. 8. The Type 715-B Oscilloscope gives a steady, faithful portrayal of the 500 kc signal. The trace reaches to the calibration marks on both positive and negative excursions. Therefore, the trace indicates that the signal voltage is 6 volts, peak-to-peak. This scope gives accurate indications of amplitude to 11 mc.

The trace on the WO-79A also gives accurate indication of the amplitude of the 500 kc signal. However, the WO-60C shows very little response to the 500 kc signal, because it is beyond the useful limit (300 kc) of the instrument. Attenuation at 500 kc explains why the trace does not extend to the calibration marks.

As a result, an erroneous reading of approximately 1.2 volts peak-to-peak is indicated.

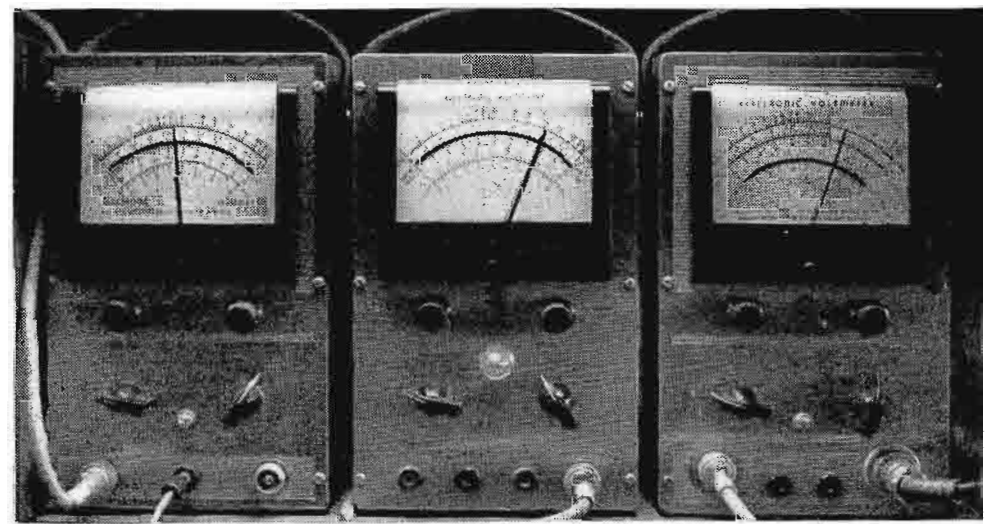

FIG. 9. Type 195-A 2 volts (rms)      Type WV-65A (with Crystal Probe) 2.15 volts (rms)      Type WV-75A 2.15 volts (rms)

**Discussion of Voltmeter Readings:** Voltmeter readings obtained with this input are shown in Fig. 9. The 195-A reading is doubtful. The WV-65A is being used in conjunction with the Crystal Probe, consequently it can accurately measure the 500 kc signal. The WV-75A is within its limit of 250 mc. Converting the rms readings gives the following:

$$2 \text{ volts} \times 1.44 = 2.8 \text{ volts peak (which is not correct)}$$

$$2.15 \text{ volts} \times 1.41 = 3 \text{ volts peak (which is correct, since both peaks are equal)}$$

$$2.14 \text{ volts} \times 2.83 = 6 \text{ volts peak-to-peak (which is the actual signal voltage)}$$

# D. HOW OSCILLOSCOPES AND VT VOLTMETERS READ WHEN THE INPUT IS A 5000 CYCLE POSITIVE PULSE

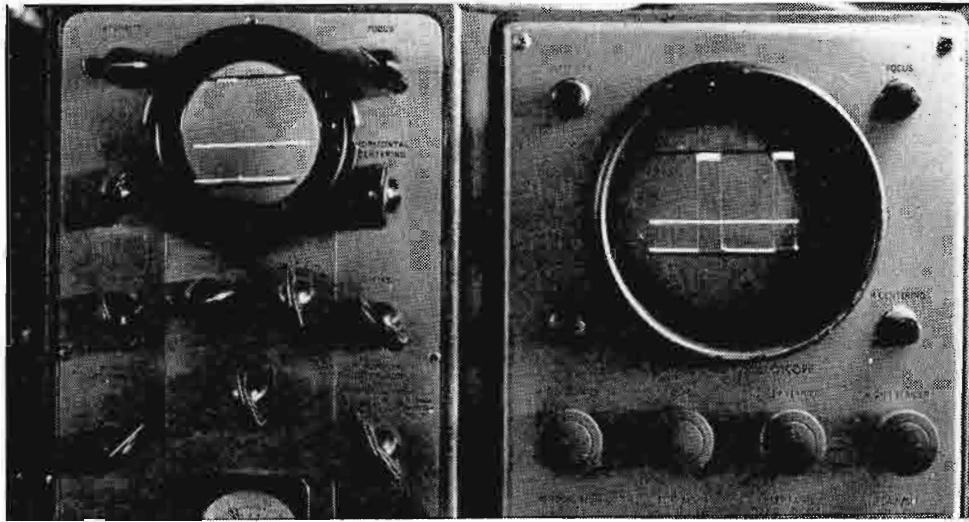

FIG. 10. (Left) Type WO79A; (right) Type WO-60C.

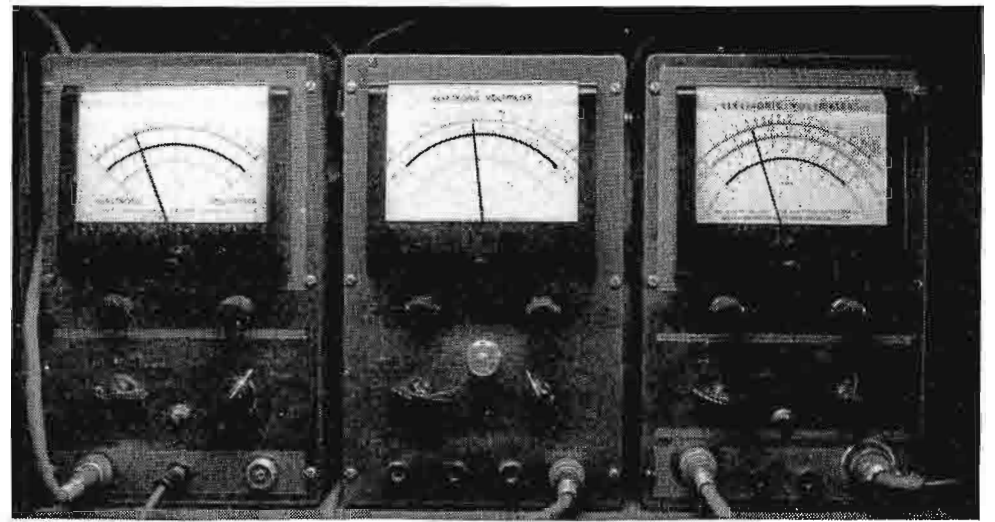

FIG. 11. Type 195-A 1.40 volts (rms) Type WV-65A (with Crystal Probe) 1.40 volts (rms) Type WV-75A 1 volt (rms)

**Input:** The input to the vertical amplifier of the two oscilloscopes and to the three VoltOhmysts is a positive excursion of 2.83 volts, with a repetition rate of 5000 cycles per second. Horizontal deflection in each oscilloscope is obtained from built-in sawtooth generators. Since two waveforms of the 5000 cycle signal appear on the screens of the oscilloscopes, it is apparent that the sawtooth frequency (time oscillator control) is set at 2500 cycles.

**Calibration:** Both oscilloscopes are calibrated at 2.83 volts peak-to-peak, which is indicated by the black lines appearing on the faces of the c-r tubes. The 195-A and the WV-65A are designed to indicate a value which is 0.707 times the positive peak value of an impressed voltage wave. The WV-75A is designed to indicate a value which is 0.3535 times the peak-to-peak value of an impressed voltage wave.

**Characteristics of the Input Signal:** The 5000 cycle-per-second positive pulse contains a multiplicity of harmonics—which is characteristic of all rectangular waves. Since the wave repeats itself 5000 times per second, each complete waveform has a duration of 200 microseconds. Sixty microseconds is the duration

of the pulse, and 140 microseconds is the time interval between pulses.

**Discussion of Oscilloscope Patterns:** Oscilloscope patterns obtained with this input are shown in Fig. 10.

Faithful reproductions of the pulsed signal are portrayed by both oscilloscopes. Because of the slow repetition rate (5000 cycles per second) as well as the comparatively long duration (60 microseconds) of the pulse, the low-frequency WO-60C gives practically the same quality of reproduction as the high frequency WO-79A. The pulse appears perfectly rectangular in both traces, showing that the harmonics are seen faithfully reproduced. (The vertical lines on the WO-60C trace are absent on the WO-79A trace because of the high-speed rise time of the latter.)

The traces on both screens result from double exposure photographs. The waveform was first photographed. Then the input signal was removed, and another exposure made on the same plate without moving either the camera or the oscilloscope. This second exposure gives the continuous horizontal line seen superimposed on the waveform. It is zero line of the wave and results

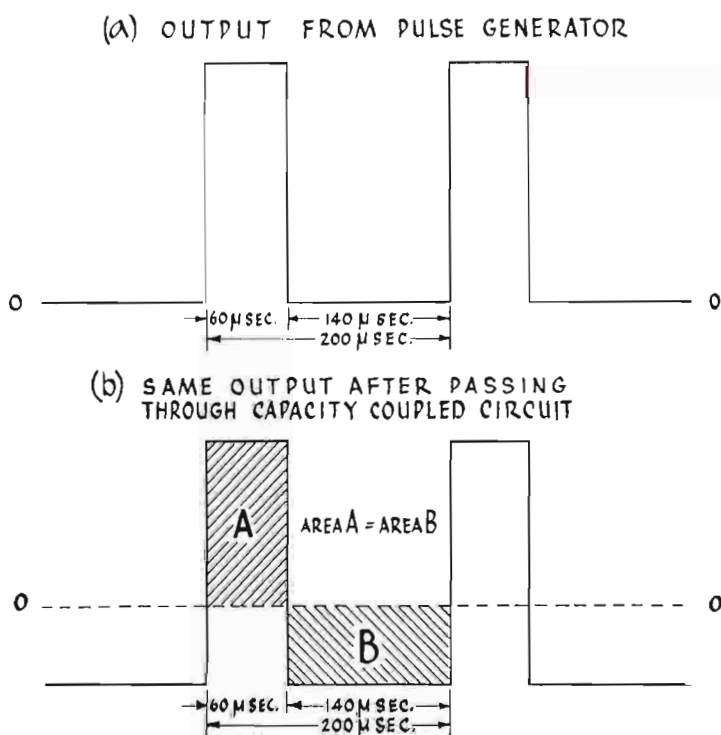

FIG. 12. Averaging effect of capacity-coupled circuit upon positive pulse.

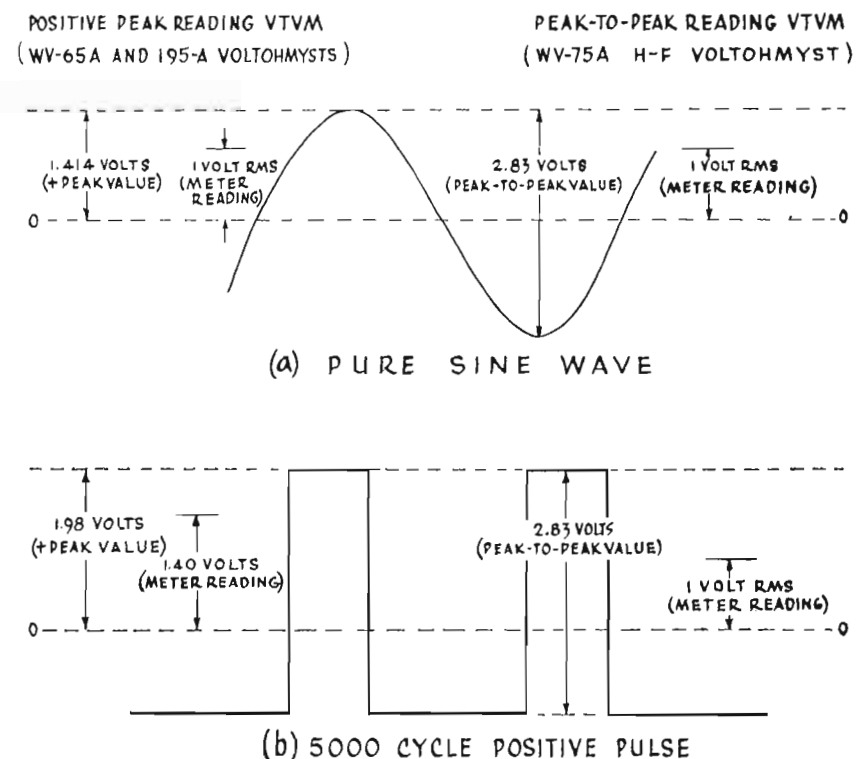

FIG. 13. How VTVM's measure sine waves and positive pulses.

from the input signal being passed through the condenser in the oscilloscope amplifier circuits. It will be noted that the area above and below the zero line appears equal, as shown in Fig. 12.

In order to understand what happens when the pulse signal is fed to the oscilloscopes and to the meters, it is helpful to recall the fact that any signal fed to a capacity-coupled circuit will automatically *average* itself. In other words, after a positive pulse has passed through a condenser circuit, the zero line is displaced upwards as shown in Fig. 12, so that area A is equal to area B. Since scopes and VTVM's are usually capacity-coupled, this effect will be noticeable in their performance.

**Discussion of Voltmeter Readings:** Voltmeter readings obtained with this input are shown in Fig. 11.

The 1.40 volts readings are given by the meters that pass voltage of one direction only. These instruments measure from zero to the value of the positive peak of any waveform. The 1 volt reading is given by the WV-75A, which passes voltages of both directions, so that it measures from peak to peak of any waveform. This will be more easily understood by referring to Fig. 13 and the following explanation.

Although a positive peak reading meter actually measures the amplitude of the positive peak of any wave applied to it, the scale is calibrated to indicate that value divided by 1.414. In the case of a sine wave this scale reading is the rms voltage value. For any other wave shape the scale reading is not the rms value; it is merely the positive peak voltage divided by 1.414.

Similarly, a peak-to-peak reading meter measures the peak-to-peak voltage of a wave but the scale is calibrated to indicate that value divided by 2.828. The scale reading, therefore, constitutes the rms value when measuring a sine wave, but for other waves the reading is merely the peak-to-peak voltage divided by 2.828. Only the peak-to-peak reading instrument (WV-75A) gives a reading proportional to the total amplitude of the pulsed

signal voltage. Multiplying this reading (1 volt) by the constant (2.828) gives the total amplitude (2.83) volts of the pulsed signal used in this test.

In this particular test, the total amplitude can also be calculated from the value (1.40 volts) given by the positive peak reading instruments, but the calculation involves the pulse width factor and the period factor. (This calculation is carried out below.) In a case wherein the pulse width and the period are unknown, the peak reading meters cannot be used to calculate the total amplitude of this or similar signals.

Unless the user is aware of the characteristic of his meter he may be using misleading information. No matter what the calibration may be, his standard type of VTVM reads the peak voltage only (usually the positive peak). The WV-75A VoltOhmyst rectifies voltages from both directions, hence it gives peak-to-peak readings. Although the two types of instruments give different readings, each type is correctly reading the value it is designed to read. For example, the accuracy of the 1.40 volts reading may be demonstrated by referring to Figs. 10-13 then carrying out the following calculation:

- (1)  $1.40 \times 1.414 = 1.98$  (positive peak value)
- (2)  $\frac{60 \text{ u sec} \times 1.98 \text{ volts}}{140 \text{ u sec}} = 0.85$  volt (negative peak value)
- (3)  $1.98 \text{ volts} + 0.85 = 2.83$  volts peak-to-peak (total amplitude)

The accuracy of the 1 volt reading of the WV-75A may be demonstrated as follows:

$$1 \text{ volt} \times 2.828 = 2.83 \text{ volts (total amplitude)}$$

Also, the accuracy of the displaced zero line (illustrated in Fig. 12 and shown on the scopes) may be demonstrated:

- (1) Area "A" =  $0.00006 \text{ sec} \times 1.98 = 0.00119$
- (2) Area "B" =  $0.00014 \text{ sec} \times (2.83 - 1.98) = 0.00119$
- (3) Therefore Area "A" = Area "B"

## E. HOW OSCILLOSCOPES AND VT VOLTMETERS READ WHEN THE INPUT IS A 5000 CYCLE NEGATIVE PULSE

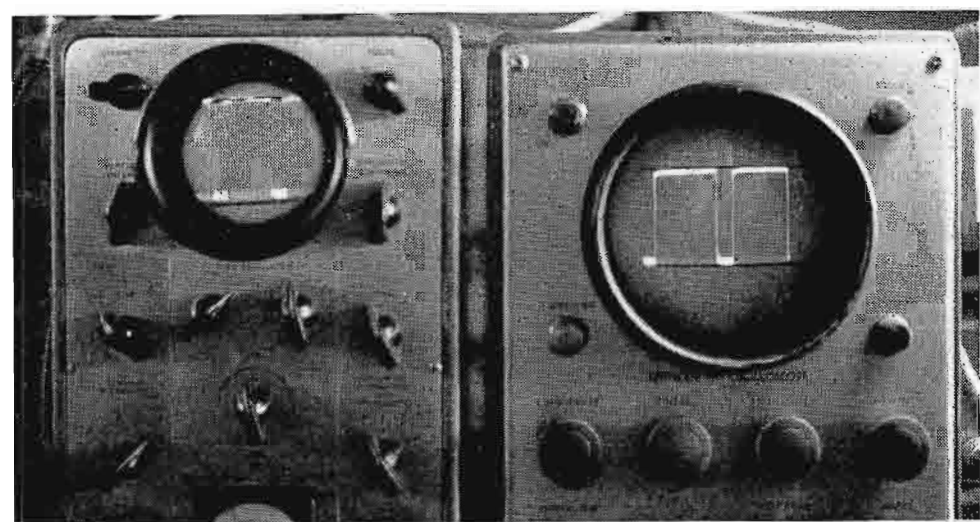

FIG. 14. (Left) Type WO-79A; (right) Type WO-60C.

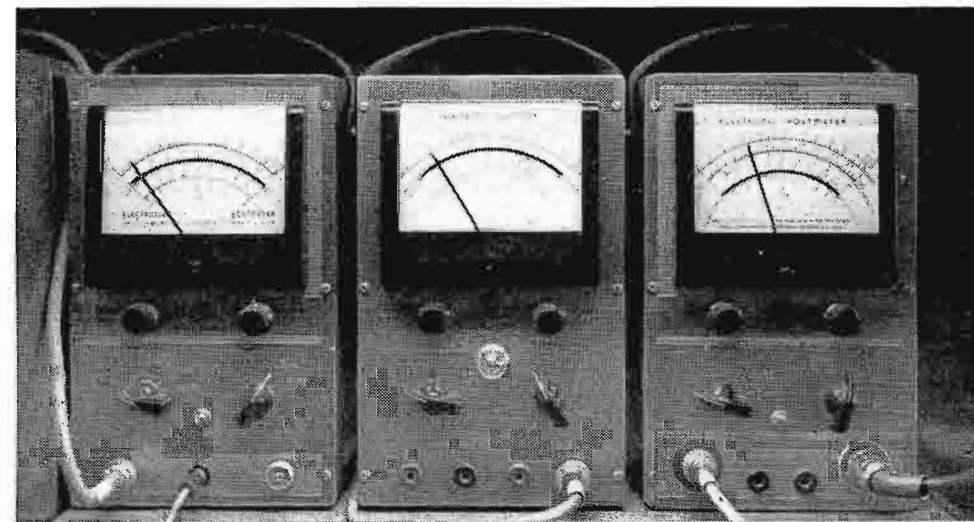

FIG. 15. Type 195-A 0.5 volts (rms)      Type WV-65A (with Crystal Probe) 0.5 volts (rms)      Type WV-75A 1 volt (rms)

**Input:** The input to the vertical amplifiers of the two oscilloscopes and to the three VoltOhmysts is a negative excursion of 2.83 volts, with a repetition rate of 5000 cycles per second. Horizontal deflection in each oscilloscope is obtained from built-in sawtooth generators. The sawtooth frequency is set at 2500 cycles, therefore, 2 complete waveforms of the 5000 cycle signal appear on the screens.

**Calibration:** Both oscilloscopes are calibrated at 2.83 volts peak-to-peak, which is indicated by the black lines appearing on the faces of the c-r tubes. The 195-A and the WV-65A VoltOhmyst are designed to indicate a value which is 0.707 times the positive peak value of an impressed voltage wave. The WV-75A is designed to indicate a value which is 0.3535 times the peak-to-peak value of an impressed voltage wave.

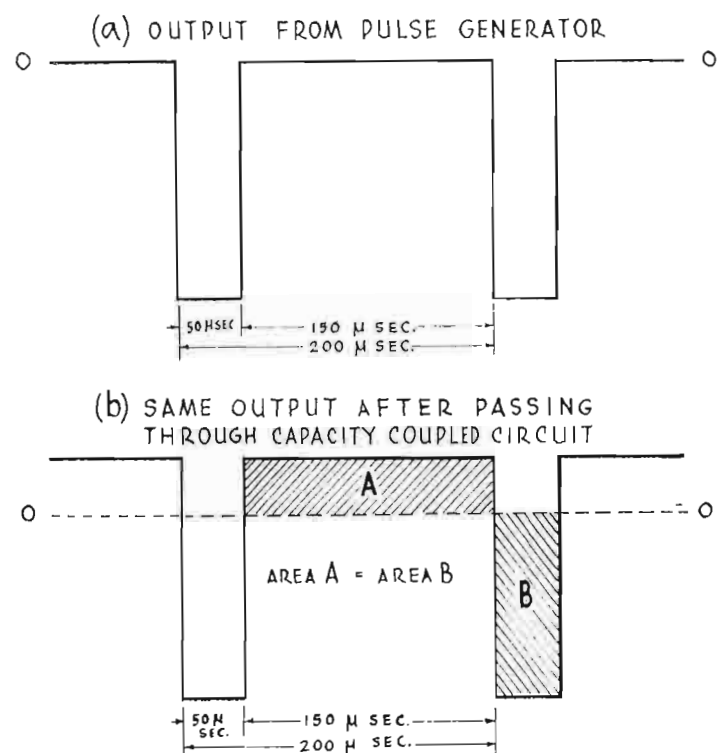

FIG. 16. Averaging effect of capacity-coupled circuit upon negative pulse.

**Characteristics of the Input Signal:** The 5000 cycle-per-second negative excursion contains a multiplicity of harmonics—a characteristic of rectangular waves. Since the wave repeats itself 5000 times per second, each complete waveform has a duration of 200 microseconds. Fifty microseconds is the duration of the pulse, and 150 microseconds is the time interval between pulses.

**Discussion of Oscilloscope Patterns:** Oscilloscope patterns obtained with this input are shown in Fig. 14. Faithful reproduction of the pulsed signal are portrayed by both oscilloscopes. In this case the narrow bandwidth WO-60C serves as well as the wide bandwidth WO-79A because the WO-60C has a useful range to 300,000 cycles, which makes it capable of revealing distortion extending to the 60th harmonic of the 5000 cycle signal. (The vertical lines are absent on the WO-79A trace because of the high-speed rise time.)

Since oscilloscopes use capacity-coupled amplifiers to eliminate d-c, the effect illustrated in Fig. 16 will be present in their performance. It will be noted that in this case the zero line is displaced downwards, so that area A is equal to area B. This same effect will be noticeable in the performance of VTVM's.

**Discussion of Voltmeter Readings:** Voltmeter readings obtained with this input are shown in Fig. 15.

The 195-A and the WV-65A read proportional to the positive peak value of the signal. (It is not possible to read both peaks by reversing the probe connection because of capacity effects induced when the instrument case is connected to the high side of the signal.)

The standard positive-peak reading VTVM measures the amplitude of positive peak of a sine wave or a pulse. This value is divided by 1.414 to give the arbitrary scale indication. Thus in order to obtain the value of the positive peak it is necessary to multiply the reading by 1.414.

The peak-to-peak reading VTVM measures the peak-to-peak value of a sine wave or a pulse. The meter scale shows the result of dividing the peak-to-peak value by 2.828. Thus to obtain the total amplitude of a pulse it is necessary to multiply the meter reading by 2.828.

Since the WV-75A employs a full-wave diode it measures proportional to the peak-to-peak value of the signal. This duo-diode VTVM is the only type of instrument that gives a reading which is proportional to the total amplitude of any waveform. In this

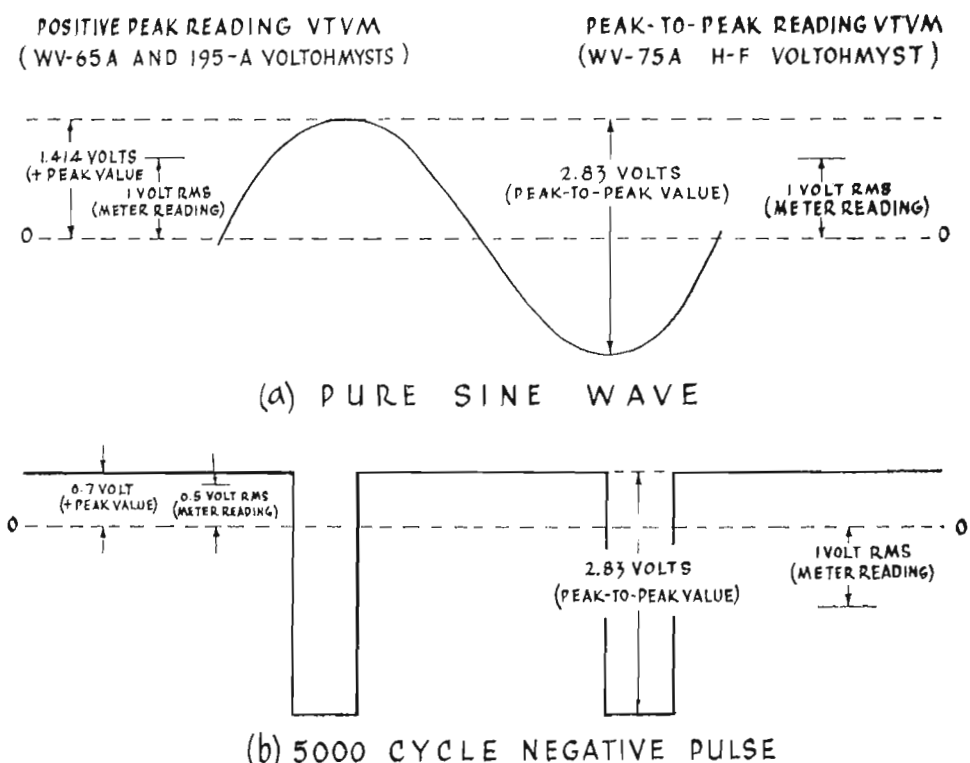

FIG. 17. How VTVM's measure sine waves and negative pulses.

particular case, the total amplitude can also be calculated from the value (0.5 volt) given by the positive peak measuring instruments, but the calculation is complex, involving the pulse width factor and the period factor. (This calculation is carried out below.) In a case in which the pulse width and the period are unknown, the standard VTVM cannot be used to calculate the total amplitude of this or similar signals.

Again, it is seen that the vacuum tube voltmeter employing a half-wave rectifier cannot measure the total amplitude of a pulsed voltage. The difference in readings given by the two types of instruments is sharply accentuated as pulse width is decreased. The zero line approaches the base line as pulse width is decreased. In such a case the WV-75A reading remains at the same point, since the peak-to-peak voltage remains the same, however, as the zero line approaches the base line, the meters which read from zero to positive peak give a decreasing reading. Change of the pulse repetition rate also changes the positive peak value, but not the peak-to-peak.

Although the two types of VTVM give different readings, each type is correctly reading the value it is designed to read. For example, the accuracy of the 0.5 volt reading may be demonstrated by referring to Figs. 14-17 and carrying out the following calculation:

- (1)  $0.5 \times 1.414 = 0.71$  (positive-peak value)
- (2)  $\frac{150 \text{ u sec} \times 0.71 \text{ volt}}{50 \text{ u sec}} = 2.12$  volts (negative-peak value)
- (3)  $2.12 \text{ volts} + 0.71 = 2.83$  volts peak-to-peak (total amplitude)

The accuracy of the WV-75A 1 volt reading may be demonstrated as follows:

$$1 \text{ volt} \times 2.828 = 2.83 \text{ volts (total amplitude)}$$

Also, the accuracy of the displaced zero line (illustrated in Fig. 14 and shown in scope trace) may be demonstrated:

- (1) Area "A" =  $0.00015 \text{ sec} \times 0.71 \text{ volt} = 0.000106$
- (2) Area "B" =  $0.00005 \text{ sec} \times (2.83 - 0.71) \text{ volt} = 0.000106$
- (3) Therefore, Area "A" = Area "B"

## F. HOW OSCILLOSCOPES AND VT VOLTMETERS READ WHEN THE INPUT IS A 50 CYCLE SQUARE WAVE

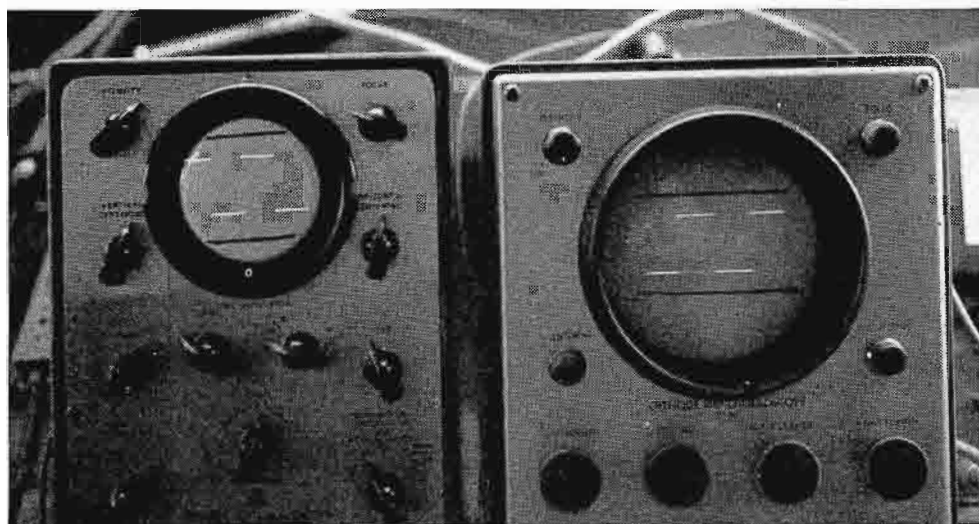

FIG. 18. (Left) Type WO-79A; (right) Type WO-60C.

**Input:** The input to the vertical amplifiers of the two oscilloscopes and to the three VoltOhmysts is a 50 cycle square wave. Horizontal deflection in each oscilloscope is obtained from the built-in sawtooth generator. Since two complete waveforms of the 50 cycle signal appear on the screens of the oscilloscopes, the sawtooth frequency is set at 25 cycles.

**Calibration:** The oscilloscopes are not calibrated in this test but the amplitudes are set at a convenient height in order to detect phase shift tilt on either the top or bottom of the traces. The WV-65A VoltOhmyst is being used with the Crystal Probe, which gives the instrument a frequency range from 1000 cycles to 100 mc.

**Characteristics of the Input Signal:** Square waves contain a multitude of harmonics. Fig. 20 shows how a fundamental and harmonic may be combined to synthesize a square waveform. There is shown a fundamental frequency; its third harmonic of one-third the fundamental amplitude and its fifth harmonic of one-fifth the fundamental amplitude. These waves are added, point for point. Adding the third harmonic to the fundamental makes the sum approach a square wave. Adding both the third and the fifth harmonic to the fundamental makes the sum further approach a square wave. The square wave itself is composed of an infinite number of harmonics.

**Discussion of Oscilloscope Patterns:** Oscilloscope patterns obtained with this input are shown in Fig. 18.

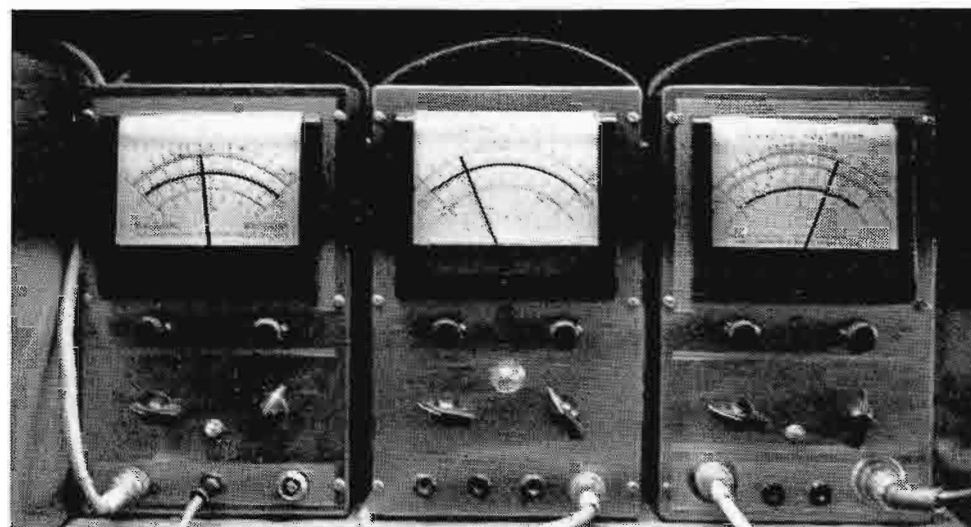

FIG. 19. Type 195-A 2.3 volts (rms)      Type WV-65A (with Crystal Probe) 0.8 volts (rms)      Type WV-75A 2.1 volts (rms)

Tests (A), (B), and (C) showed the limitations of a low-frequency oscilloscope in connection with high-frequency signals. This test demonstrates the opposite effect.

The trace on the WO-79A shows an extremely slight tilt of the 50 cycle square wave. This is caused by a small amount of phase shift in the amplifiers, which occurs at 50 cycles. As the frequency decreases, the tilt becomes more pronounced. The WO-60C, on the other hand, gives an exact reproduction of the 50 cycle square wave. This is because the WO-60C has negligible phase shift at 50 cycles. The WO-60C has a useful range down to  $\frac{1}{2}$  cycle. It is especially useful for low-frequency work.

**Discussion of Voltmeter Readings:** Voltmeter readings obtained with this input are shown in Fig. 19.

Because the WV-65A is being used with the Crystal Probe that has a low frequency limit of 1000 cycles, the reading of 0.8 volts is doubtful. The other readings are in substantial agreement. Converting the rms readings:

$$2.3 \times 1.41 = 3.2 \text{ volts positive peak}$$

$$2.1 \times 2.83 = 5.9 \text{ volts peak-to-peak}$$

The 195-A does not give exactly one-half the value of the WV-75A reading (as one would suppose) because of shape of the 50 cycle wave. The signal is negative for a longer duration than it is positive. Hence, the positive peak reading is higher than the negative.

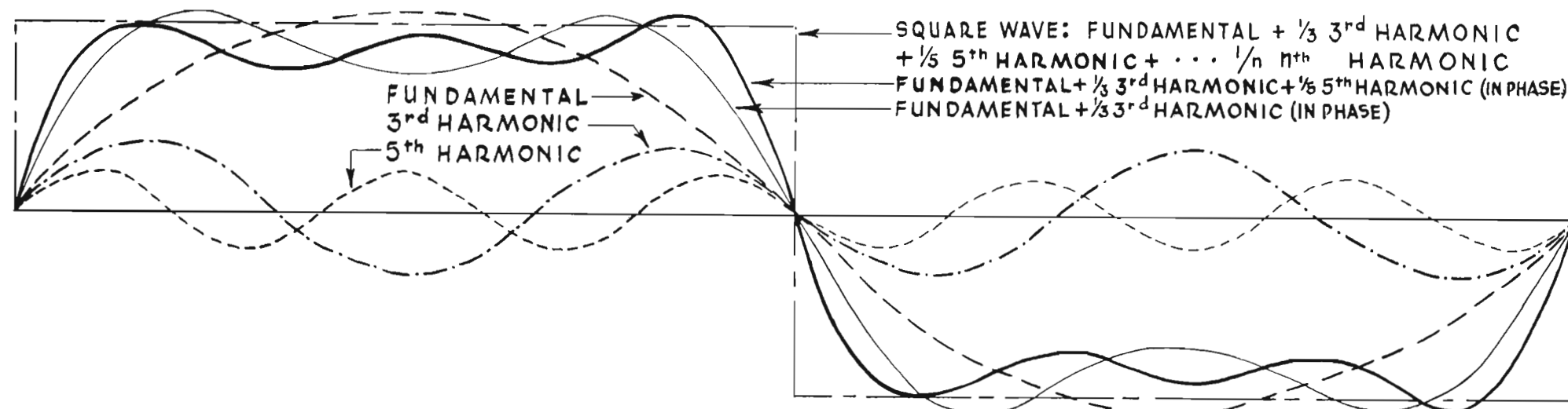

FIG. 20. This figure shows how a square wave is made up of the fundamental plus harmonics in a diminishing series. Only the third and fifth harmonics are shown in this diagram. As will be seen, adding the third tends to flatten off the top of the curve. Adding the fifth makes it still flatter, and more nearly square. The more harmonics are added, the more nearly square it becomes.

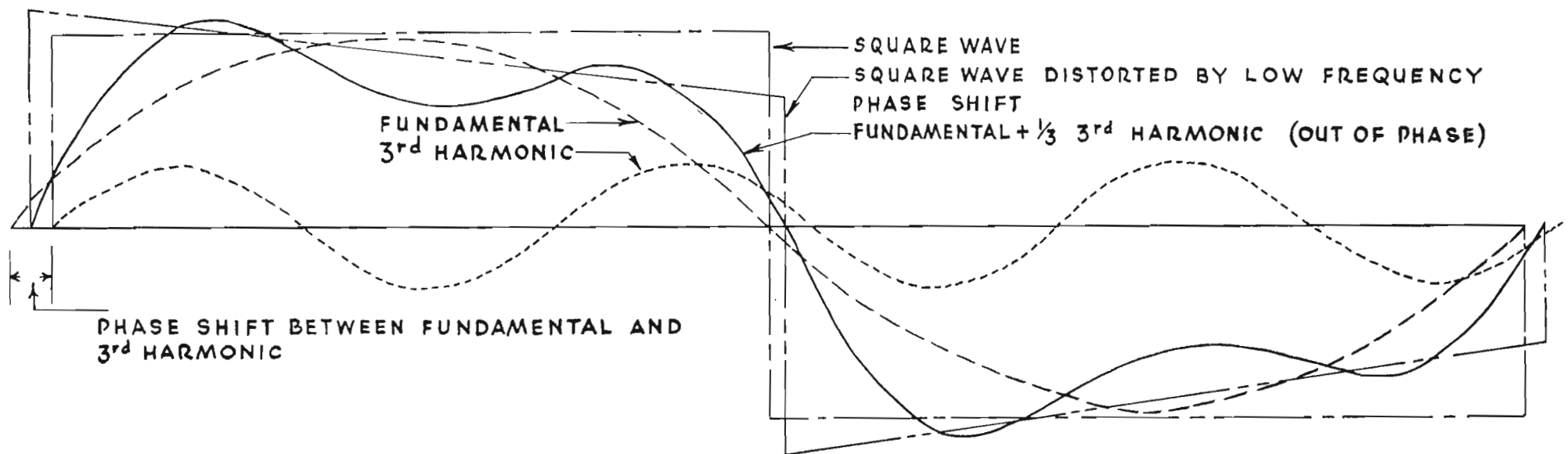

FIG. 21. This figure shows the effect of phase shift. The fundamental frequency is shown slightly out of phase with its third harmonic. When the fundamental and shifted harmonic are added, the resulting wave has a tilt. Similarly, a square wave which has some of its components shifted in phase will show a tilt.

## G. HOW OSCILLOSCOPES AND VT VOLTMETERS READ WHEN THE INPUT IS A TELEVISION SYNC PULSE

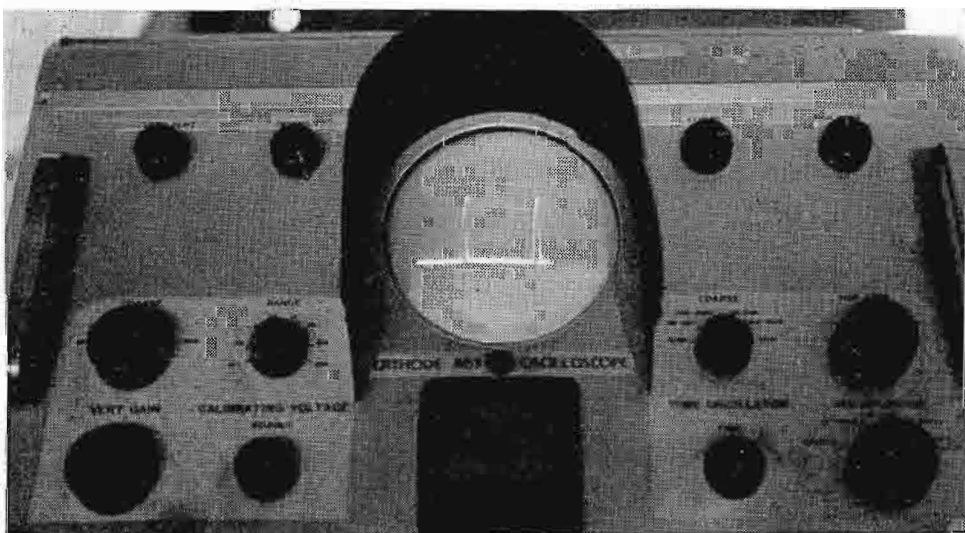

FIG. 22. Oscilloscope, Type 715-B.

**Input:** The input to the vertical amplifier of the Type 715-B Oscilloscope and to the two VoltOhmysts is a horizontal sync pulse from a television receiver. Horizontal deflection in the 715-B is obtained from a built-in time oscillator.

**Calibration:** The horizontal deflection control of the 715-B is set to give periodic deflection (rather than triggered or aperiodic deflection). Since two complete pulses of the 15,750 cycle signal appear on the screen, the sawtooth deflection frequency is exactly one-half that of the signal frequency. The Battery Volt-Ohmyst, Type WV-65A, is being used with the auxiliary Crystal Probe, which gives it a frequency range of 1000 cycles to 100 mc.

**Characteristics of the Signal:** The sync pulse has a repetition rate of 15,750 cycles per second. A pulse of this kind includes a great many high-frequency components. Hence, an oscilloscope with wide bandwidth amplifiers is required to faithfully portray this signal.

**Discussion of Oscilloscope Pattern:** The oscilloscope pattern obtained with this input is shown in Fig. 22.

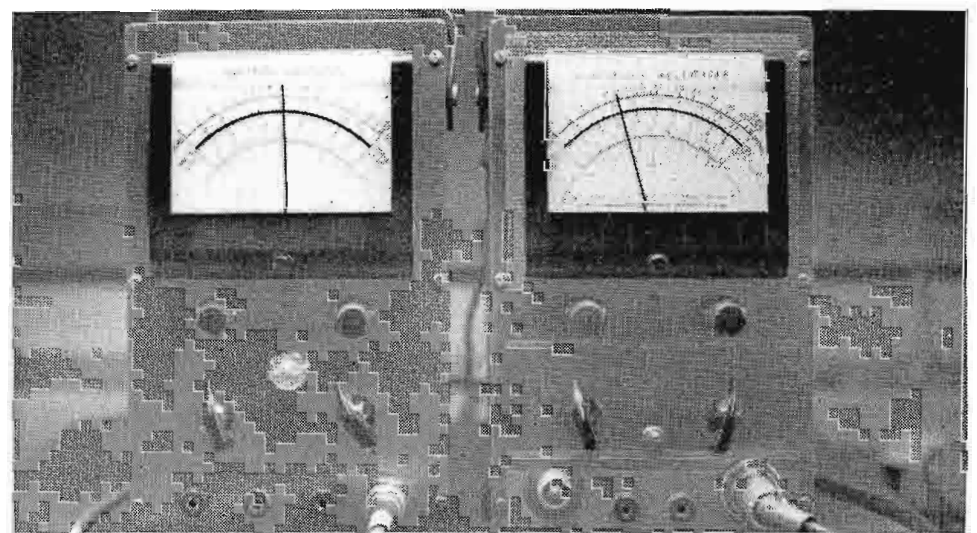

FIG. 23. Type WV-65A (with Cristay Probe( 15 volts (rms); Type WV-75A 10 volts (rms).

The trace clearly portrays the pulse. This high frequency oscilloscope passes all the frequency components of the signal through its wide bandwidth amplifiers to give faithful reproduction of the 15,750 cycle sync pulse. With a range of 5 cycles to 11 mc, it is the type of instrument to be used in a television station where the utmost in accuracy is required.

**Discussion of Voltmeter Readings:** Voltmeter readings obtained with this input are shown in Fig. 23.

The peak reading instrument (WV-65A) gives a value of 15 rms volts, while the peak-to-peak reading instrument (WV-75A) gives a reading of 10 rms volts. Converting these values we get:

$$\begin{aligned} 15 \times 1.41 &= 21.2 \text{ volts (positive peak value)} \\ 10 \times 2.83 &= 28.3 \text{ volts (peak-to-peak value)} \end{aligned}$$

The 15 rms volts reading of the WV-65A is actually 21.2 volts peak. However, this is not the peak-to-peak excursion of the signal. Only a duo-diode instrument such as the 75A gives the exact, qualitative information. Without such information, accurate adjustments—made on the basis of the true operating characteristics of tubes and circuits—are difficult, if not impossible.



## ABC ENGINEERS EXAMINE RCA TV EQUIPMENT

Television engineers of the ABC network exchanged ideas with RCA officials and design engineers during a recent two-day tour of the Lancaster and Camden plants of the RCA Victor Division following the NAB convention. Shown inspecting RCA image orthicon camera are: J. L. Middlebrooks, Chief Facilities Engineer of ABC; Edward J. Meehan, RCA Commercial Television Engineer; George O. Milne, ABC Director of Technical Operations; Edward Horstman, Engineering Director for ABC Central Division; Philip Caldwell, ABC Division Engineer for the West Coast; Robert Morris, of the ABC Development Engineering Section; Al Josephson, RCA's New York Field Sales Representative; James Valentine, Operations Supervisor at Station WENR-TV; and Dana Pratt, RCA Merchandise Manager for Transmitter Equipment.

## WGN-TV WINS NEW RCA TURNTABLE

Carl J. Meyers, Director of Engineering for WGN, Inc., recently won a shiny new RCA 70-D turntable. This came as a result of a contest conducted by RCA, in which radio stations reported the RCA 70-D turntable which had been in service for the longest period of time. The reward for the oldest table was a brand new \$630., 70-D turntable.

WGN located a 70 series unit obtained in 1935, which was still in everyday use at WGN-TV. A letter from Wayne L. Babcock also stated that RCA records revealed the WGN turntable to be the very first one that RCA shipped on April 15, 1935. The new 70-D turntable is now doing a job in the WGN-TV operation, and the 14-year veteran occupied an honored spot in the RCA booth at NAB convention.

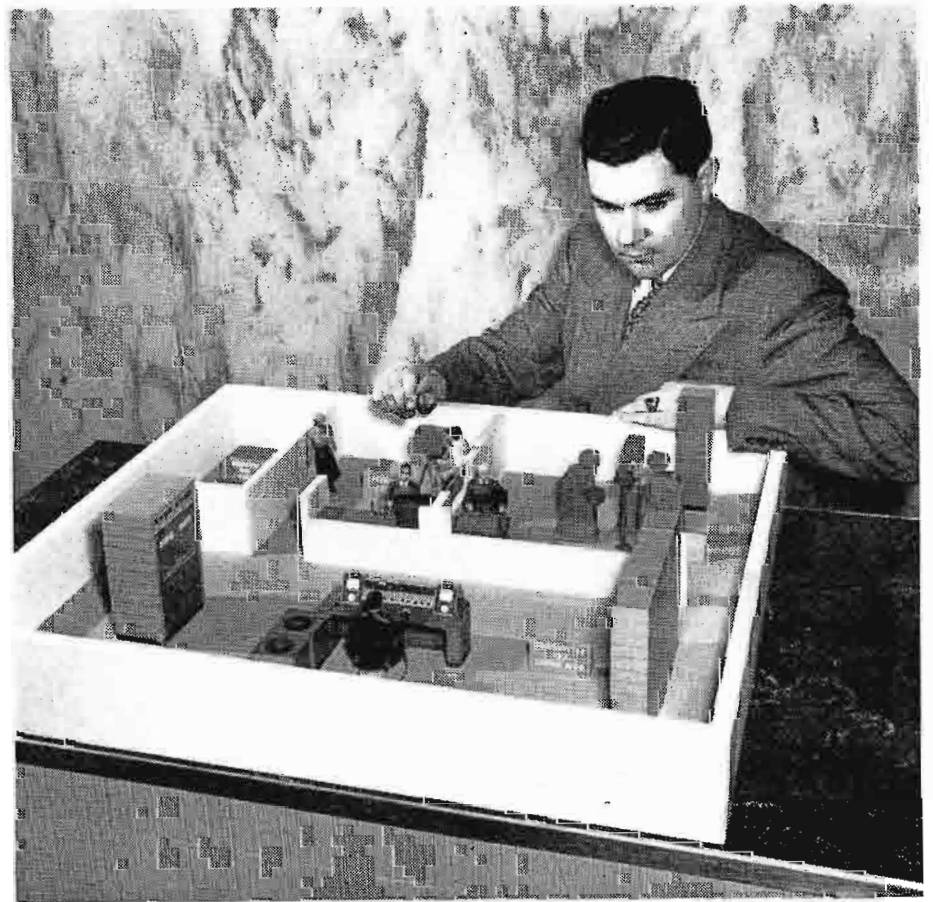

## NEW TV PACKAGE CUTS EQUIPMENT COSTS TO MINIMUM

Mr. E. J. Meehan of our television broadcast sales group surveys a scale model of a complete, low-cost television station, known as "Basic Buy." Unlike anything ever offered the broadcast industry in the form of a package, this television operation contains new design features which cut costs to a minimum. These features also make possible a series of different layouts adapted to use in areas where television broadcast service is presently needed.

An article or series of articles pointing out various opportunities in low-cost TV, replete with diagrams and description will be published in a forthcoming issue of BROADCAST NEWS.



# THE PHILOSOPHY OF OUR TV SYSTEM

## A Brief Review of the Functions of the Most Important Parts of the TV System, With An Explanation of the Reasoning Behind the Choice of Standards, Type of Transmission, Shape of Synchronizing Pulse, Etc.

by JOHN H. ROE

Supervisor  
TV Systems Engineering Group  
Engineering Products Department

### PART III

EDITOR'S NOTE: Previous parts of this article were published in BROADCAST NEWS, Vol. 53 and Vol. 54. A reprint of all three parts is also available.

#### Automatic Frequency Control of Scanning

The constant search for means of immunization against the effects of noise has brought about the development of automatic frequency control (afc) of the scanning circuits in television receivers. In triggered circuits, each scanning line (and each field) is initiated individually by a pulse in the incoming signal. Contrastingly in an afc system, scanning generators are governed by stable oscillators which in turn are controlled by voltages obtained from phase comparison of the incoming sync. pulses with the scanning signals themselves. The time-constant of the comparison circuit is usually made long compared to the period of the scanning so that random noise pulses have very little effect on the resulting control voltage, and correspondingly little effect on the scanning frequency. The fact that such afc circuits

are keyed circuits provides a further immunization factor by eliminating the possible effect of all noise pulses except those which coincide with the short keying intervals. The use of afc scanning circuits makes possible accurate synchronizing of a receiver under such bad conditions of noise that the masking of the picture by the noise renders it completely unusable. Thus failure to synchronize may be largely eliminated as a limiting factor in picture reception.

Afc may be used with both vertical and horizontal scanning circuits, but so far is being used commercially for horizontal circuits only. One reason for not using afc with the vertical circuits is that the time-constant must be very long to provide a stable control voltage. As a result, the circuit will not recover from an extended interruption of the incoming signal until an intolerably long time has elapsed. The frequency of the oscillator drifts during an interruption, and may not recover for a large number of seconds after the signal returns. During the period of recovery, the raster rolls over continuously at a decreasing rate until control is restored. The time-constant of the horizontal circuit, on

the other hand, may be short enough so that recovery takes place in less than one field. Triggered scanning circuits, of course, recover from signal interruptions very rapidly, but they do not have the same high immunity to noise that the afc circuits have.

As a result of the use of afc circuits in receivers, a high degree of frequency stability is required in the horizontal sync. and blanking signals. Frequency modulation of the horizontal pulses is intolerable because it causes the right and left hand edges of the blanked raster in the receiver, as well as vertical lines in the scene, to assume the same shape as the modulating wave. As shown in Fig. 10 the border of the complete raster in the receiver is rectangular, but frequency modulation of the horizontal sync. and blanking will distort the shape of the border produced by blanking. Frequency modulation by a 60-cycle sine wave is illustrated.

Horizontal retrace begins along a straight vertical line regardless of timing and since this retrace is controlled by a stable oscillator in the receiver which is not responsive to short-time changes in sync. timing, the



FIG. 10 (right). Effect of frequency modulation of horizontal sync and blanking on shape of raster in receiver with AFC of horizontal scanning.

presence of variations in sync. timing and of corresponding changes in blanking pulse timing, will show as a displacement of the edges of the blanked raster. The frequency stability of the sync. generator must therefore be at least equal to the stability of the oscillators used in a-f-c receivers. The maximum rate of change of frequency allowable in a sync. generator has been specified by RMA as 0.15% per second. This is a rather strict tolerance as indicated by the fact that it allows a total displacement of only 1/32 of an inch (approx.) in a period of one field in a picture 10 inches wide.

### Film Projection

The use of standard sound motion picture film for television program material offers a special problem which arises from the difference in the picture repetition rates used. For reasons explained previously, the rate used for television is 30 frames and 60 fields per second. The standard speed for sound film, both 16mm and 35mm, is 24 frames per second, and since each frame is projected twice, the picture rate is 48 per second. The basic problem of reconciling the frequency difference has been met by using special projectors for television in which alternate frames of the film are projected twice and the remainder are projected three times. In this way, 60 pictures are obtained in place of the usual 48, but the average speed of the film through the projector is unchanged; hence the sound take-off is entirely normal.

Another problem also presents itself in the use of intermittent film projectors for television. The vertical scanning period occupies from 92% to 95% of the total period. If the projected image is to be thrown on the pickup tube during the scanning period at all, it must be for the entire time so that all parts of the area will be subject to the same lighting conditions. Such an arrangement would leave only the vertical retrace period (5% to 8% of the total, or approximately one thousandth of a second) in which to pull down the film to the next frame. 35mm film will not stand up under accelerations produced by sprocket hole pull-down in such a short period; hence some other scheme must be used. The method which has been adopted for use with intermittent projectors makes use of the storage property of certain kinds of pickup tubes, such as the iconoscope. The frame of film is projected with very intense illumination during the vertical blanking period only, while neither the pickup tube nor the receiver is being scanned. Then the light is cut off and the pickup tube is scanned in the ab-

sence of any optical image from the film. The signal generated during this scan results from charges stored on the sensitive surface during the preceding flash of light. While the light is cut off during the scan there is ample time to pull the film down before the next flash of light, without exerting destructive forces. The pulses of light may be obtained by chopping the output of a continuous source with a rotating disk, or (with a special type of arc lamp) by pulsing the source itself by electronic means. The storage properties of pickup tubes for this purpose must be sufficiently good so that dissipation of the stored charges is negligible between light pulses. Appreciable dissipation causes loss of contrast at the bottom of the picture.

Another solution to the problem of film projection in television is the use of a continuous projector, a type which produces a stationary image from continuously moving film by means of moving mirrors or lenses. This solution has not been accepted commercially so far because of practical difficulty in making the optical system sufficiently accurate to stop motion of the image completely.

The film problem in England, Europe, and other areas where 50 cycle power systems are standard, and where the television field frequency is also 50 cycles per second, is simpler in one respect, namely that it is not necessary to use the two-three ratio for projection of alternate frames of film. Instead, the film is projected as it is in theaters where each frame is projected twice. No attempt is made to compensate for the difference between the 24 frame taking speed and the 25 frame projection speed. The results are an approximate 4% increase in the apparent speed of motion of objects in the scene (which is probably negligible) and a slight rise in the pitch of all sounds. This latter effect is the more objectionable of the two, though generally it is not noticeable in speech and many other ordinary sounds. The change in pitch is undoubtedly noticeable to the trained musician in the case of musical sounds and must produce an unpleasant mental reaction to the music. However, no easy solution to the problem is known, and the situation is accepted without serious complaint. The other aspects of the film problem are not affected by the use of 50 fields instead of 60.

## PROPAGATION METHODS

### Modulation

The choice of amplitude modulation for television transmitters was made after comparison of results of a-m and f-m transmissions in field tests in the New York

area. The results indicated clearly that f-m is not suitable for use in television broadcast transmitters or in any television radiating system where multipath transmission is encountered. The reason may be understood easily. Multipath transmission in any case means that signals arrive at the receiving antenna from two or more directions, one of which is usually the direct path from transmitter to receiver, and the others indirect paths along which the signal is reflected by objects which are off to the side of the direct path. In the a-m case, a reflected signal, which arrives after the direct signal, produces a single ghost or other repetition of the scene displaced to the right by a distance equivalent to the increase in delay over the longer reflected path. The intensity of the ghost depends on the relative strengths of the two signals. In the f-m case, the delay in the reflected signal can mean that two distinct carrier frequencies arrive at the receiver simultaneously. When this happens, the resulting beat between the two frequencies appears in the picture in the form of a moiré pattern, or multiple repeat after each object. The frequency of the repeats, or spacing of the moiré, is a function of the contrast between adjacent areas in the scene; hence it varies constantly with changes in the scene. The most objectionable moiré is produced by the blanking pulses because they usually represent the largest possible contrast. Where multipath transmission is not present, as in the case of point-to-point relaying systems using highly directive antennas, f-m may be used with excellent results.

American and British standards are at variance in the matter of polarity of transmission. In Great Britain, positive transmission is used. Positive transmission means simply that the carrier is modulated so that an increase in picture brightness brings about an increase in carrier amplitude. In negative transmission, adopted as standard in this country, an increase in picture brightness brings about a decrease in carrier amplitude. Thus sync. peaks represent maximum carrier. The principal points presented in favor of negative transmission are these:

1. An improvement in efficiency is realizable with negative transmission in the case of high level grid modulation. As stated previously, sync. pulses in the negative system represent maximum carrier. Because they are rectangular pulses, any saturation in an amplifier cannot affect their wave shape, but simply reduces their amplitude. Therefore it is possible to utilize the upper

non-linear end of the modulation characteristic for the sync. pulses provided they are pre-emphasized so that the ratio of sync. to picture is correct in the modulated carrier. By using this non-linear part of the modulation characteristic for sync., the entire linear portion of the characteristic is reserved for the picture signal. In the positive system, on the other hand, where the picture whites represent maximum carrier, the non-linear end of the characteristic cannot be used at all without compressing the whites in the picture signal. Furthermore, 25% of the linear characteristic is unavoidably absorbed by the sync. pulses.

2. Noise peaks which produce an increase in carrier will produce white spots, which may bloom (spread to abnormally large size) in the positive system, while they produce black spots in the negative system. Such black noise would normally be less objectionable than the white noise. In other words, the kinescope itself acts as a noise limiter in the negative system.
3. The average carrier power rating of the transmitter for given peak output is less in the negative system than it is in the positive system.
4. The signal produced in a negative transmission system lends itself to the use of simple a-v-c in receivers because sync. pulse peaks represent constant carrier level. Either peak-sensitive or keyed a-v-c circuits may be used which make use of this constant level as a reference. No such simple reference is available in the positive system.
5. Some receivers use an intercarrier sound system, i.e. a system in which the sound is obtained from the beat between the a-m picture carrier and the f-m sound carrier. This requires that the picture carrier never be driven to zero. In the positive transmission system, this requirement means that the black-reference carrier level must be raised at a further sacrifice of efficiency. In the negative system, only a slight reduction in video modulation amplitude is necessary.

Plate modulation, with its high efficiency and freedom from distortion, is not suitable for television because it is impractical to develop the necessary large amount of power in the modulator in the low impedance required by the broad band. In transmitters where high-level modulation is used the modulating signal is therefore applied to the grid circuit of the final r-f

amplifier with consequent economy in the power requirements of the modulator.

#### Polarization

The question as to which polarization of the carrier waves is better, in the portion of the spectrum used for television, is probably impossible to answer conclusively from a theoretical study alone and was, therefore, investigated experimentally. A paper on this subject by Wickizer describes an investigation carried out at three frequencies, 49.5, 83.5 and 142 mc. around New York City. This investigation indicated preponderantly higher signal strength for horizontal polarization than for vertical. In some cases there was evidence that vertical polarization was preferable within a short radius of the transmitter, but the percentage of the total service area over which this was true was very small. The largest ratio of horizontal/vertical signal strength measured in this study was 9.8 db, the average being a little over 4 db. Thus, though the difference is substantial on the average, it is not great enough to make vertical polarization unusable.

There are other advantages to horizontal polarization among which are the following. Multipath reflections in general are produced by vertical surfaces such as the sides of buildings, cliffs, and groves of trees. Both theoretical and experimental evidence shows that horizontally polarized waves are reflected from such surfaces less than those that are vertically polarized.

Investigation of the character of man-made noise signals has shown that relatively few have appreciable horizontally polarized components. Consequently there is less tendency to pick up noise in horizontal receiving antennas.

The construction of horizontal antennas is somewhat easier, in both transmitting and receiving cases, than the construction of vertical antennas. Horizontal dipoles are simple in construction and are easily balanced with respect to the earth's surface, the roofs of buildings, and supporting structures. Proper balancing of vertical dipoles is more difficult and they are usually abandoned in favor of vertical quarter wave radiators with artificial ground planes which are bulky and often difficult to handle.

The horizontal directivity of horizontal dipoles is a substantial aid in reducing the pickup of interfering signals at a receiving location.

These are probably the most important considerations which led to the adoption of horizontal polarization in this country.

#### Single Side-Band Transmission

The development of what is usually called single side-band transmission is probably one of the most valuable contributions to the television art, for it has made possible much more efficient use of the available channels, or from another standpoint, it has made possible the use of much smaller channels than would be possible otherwise.

It is well known that amplitude modulation of a wave produces a band of frequencies about the carrier as a center, the boundaries of which are the sum and difference frequencies of the carrier and the maximum frequency of the modulating signal. In the broadcasting of sound by AM it is considered desirable to include both the carrier and the upper and lower side-bands. This requirement makes necessary a total bandwidth equal to twice the highest modulating frequency. For example, for transmission of 10 kc. sound, a bandwidth of 20 kc. would be required.

In television transmission, it has been shown that partial suppression of one side-band does not detract from the quality of the picture in any way, but actually improves the results by making more space available for the other side-band. Side-band suppression is equivalent to moving the carrier toward one side of the transmission channel. In the RMA standards, the carrier is located 1.25 mc. from the low end of a 6 mc. channel, and approximately 4.5 megacycles above the carrier are allowed for the upper side-bands. The remaining part of the channel is allocated to the transmission of the sound. If all of both side-bands were to be transmitted, the channel would have to be increased in width by at least 3 mc., thus making a total channel width of 9 mc. or more. Such an increase in the width of television channels would work a serious hardship by reducing the number of channels available in a field where there is already considerable evidence of scarcity.

Single sideband transmission also permits economy in receiver design by allowing the use of a narrower i-f band. The i-f cutoff may be less abrupt so that phase shift in the upper end of the video frequency band is less severe.

Suppression of the lower side-band is accomplished in the transmitter by either of two means. In the case of high-level modulation, it is done in a filter having the required characteristics located in the antenna transmission line. In transmitters using low-level modulation, it may be done by proper tuning of the linear amplifiers following the modulated amplifier.

## References

The preceding discussion is necessarily brief and cannot serve as much more than an outline for further reading. There are many papers dealing more comprehensively with the details and problems associated with the various parts of the television system. References to some of these are included in the following bibliography. Most of the papers referred to also include references to others which, *in toto*, comprise a comprehensive list.

One book deserves special mention as a reference covering much of the engineering background of our television system. It is entitled, "Television Standards and Practice" (McGraw-Hill Publishing Co., 1943), and is essentially an abridged version of the proceedings of the National Television System Committee as edited by Donald G. Fink. It includes a statement of the standards recommended by the Committee to the Federal Communications Commission, discussion of the investigations on which the recommendations were based, and references to pertinent papers.

## Acknowledgment

The author wishes to acknowledge the helpful criticisms and suggestions made by G. L. Beers, P. J. Herbst, H. N. Kozanowski, and W. J. Poch.

## Bibliography

### SYNCHRONIZING AND SCANNING

1. "A Study of Television Image Characteristics," E. W. Engstrom, Proc. IRE, Dec. 1933; Proc. IRE, Apr. 1935.
  2. "Scanning Sequence and Repetition Rate of Television Images," R. D. Kell, A. V. Bedford, M. A. Trainer, Proc. IRE, Apr. 1936.
  3. "Television Synchronization," E. W. Engstrom and R. S. Holmes, Electronics, Nov. 1938.
  4. "Determination of Optimum Number of Lines in a Television System," R. D. Kell, A. V. Bedford, G. L. Fredendall, RCA Review, July 1940.
  5. "Postwar Television Standards," A. N. Goldsmith, Televiser (Fall) 1944.
  6. A Synchronizing Generator for the RMA Synchronizing Signal, U. S. Patent 2,258,943—A. V. Bedford.
  7. "A Precision Television Synchronizing Signal Generator," A. V. Bedford and J. P. Smith, RCA Review, July 1940.
  8. "A New Synchronizing and Blanking Signal Generator," E. Schoenfeld, W. Milwitt, W. Brown, RCA Licensee Bulletin LB-678, Aug. 1, 1946.
- ### PICKUP TUBES
9. "Television Pickup Tubes with Cathode Ray Beam Scanning," H. Iams and A. Rose, Proc. IRE, Aug. 1937.
  10. "The Image Iconoscope," H. Iams, G. A. Morton, V. K. Zworykin, Proc. IRE, Sept. 1939.
  11. "Television Pickup Tubes Using Low Velocity Beam Scanning," A. Rose and H. Iams, Proc. IRE, Sept. 1939.
  12. "The Orthicon, A Television Pickup Tube," A. Rose and H. Iams, RCA Review, Oct. 1939.
  13. "The Image Orthicon, A Sensitive Television Pickup Tube," A. Rose, P. K. Weimer, H. B. Law, Proc. IRE, July 1946.
- ### THE D-C COMPONENT
14. "DC Picture Transmission," H. N. Kozanowski, BROADCAST NEWS, Aug. 1944.
  15. "The Clamp Circuit," C. L. Townsend, Broadcast Engineering Journal, Feb. and March 1945.
  16. "New Television Field Pickup Equipment Employing the Image Orthicon," J. H. Roe, Proc. IRE, Dec. 1947.
  17. "Television DC Component," K. R. Wendt, RCA Review, March 1948.
  18. "How to Use the Television Stabilizing Amplifier," J. H. Roe, BROADCAST NEWS, May 1948.
- ### MOTION PICTURE PROJECTORS FOR TELEVISION
19. "Some Television Problems from the Motion Picture Standpoint," G. L. Beers, E. W. Engstrom, I. G. Maloff, Jour. SMPE, Feb. 1939.
  20. "Application of Motion Picture Film to Television," E. W. Engstrom, G. L. Beers, A. V. Bedford, Jour. SMPE, July 1939.
  21. "Film Projectors for Television," R. V. Little, Jr., Jour. SMPE, Feb. 1947.
- ### PROPAGATION
22. "Notes on Propagation of Waves Below Ten Meters in Length," B. Trevor and P. S. Carter, Proc. IRE, March 1933.
  23. "Television Transmitters Operating at High Power and Ultra-High Frequencies," J. W. Conklin and H. E. Gihring, RCA Review, July 1937.
  24. "Mobile Field Strength Recordings of 49.5, 83.5 and 142 Mc. from Empire State Building, New York—Horizontal and Vertical Polarization," G. S. Wickizer, RCA Review, Apr. 1940.
  25. "Vertical vs. Horizontal Polarization," G. H. Brown, Electronics, Oct. 1940.
  26. "Partial Suppression of One Side-Band in Television Reception," W. J. Poch and D. W. Epstein, RCA Review, Jan. 1937.
  27. "Single Side-Band Filter Theory with Television Applications," J. M. Hollywood, Proc. IRE, July 1939.
  28. "A Theoretical Analysis of Single Side-Band Operation of Television Transmitters," L. S. Nergaard, Proc. IRE, Oct. 1939.
  29. "Television Detail and Selective Side-Band Transmission," Stanford Goldman, Proc. IRE, Nov. 1939.
  30. "Selective Side-Band Transmission in Television," R. D. Kell and G. L. Fredendall, RCA Review, April 1940.
  31. "A Vestigial Side-Band Filter For Use With A Television Transmitter," G. H. Brown, RCA Review, Jan. 1941.
- ### RECEIVERS
32. "Television Receivers," E. W. Engstrom and R. S. Holmes, Electronics, April 1938.
  33. "Television Receiving and Reproducing Systems," E. W. Engstrom, Jour. App. Phys., July 1939.
  34. "Automatic Frequency and Phase Control of Synchronization in Television Receivers," K. R. Wendt and G. L. Fredendall, Proc. IRE, Jan. 1943.
  35. "Carrier-difference Reception of Television Sound," R. B. Dome, Electronics, Jan. 1947.
  36. "Television Receivers," A. Wright, RCA Review, March 1947.
- ### GENERAL
37. "Television Standards and Practice—N. T. S. C." edited by D. G. Fink, McGraw-Hill Publishing Co., Inc., New York, 1943.
  38. "Principles of Television Engineering," D. G. Fink, McGraw-Hill Publishing Co., Inc., New York, 1940.
  39. "Television," V. K. Zworykin and G. A. Morton, John Wiley and Sons, New York, 1940.
  40. "Cathode-Ray Tube in Television," I. G. Maloff and D. W. Epstein, McGraw-Hill Publishing Co., Inc., New York, 1938.
  41. "Television," Vol. I—RCA Institutes Technical Press, N. Y., July 1936. Vol. II—RCA Institutes Technical Press, N. Y., Oct. 1937. Vol. III—(1938-1941) RCA Review, RCA Laboratories Div., Jan. 1947. Vol. IV—(1942-1946) RCA Review, RCA Laboratories Div., Jan. 1947.
  42. "Television—A Bibliography of Technical Papers by RCA Authors (1929-1946)", Pamphlet published by RCA Review, Nov. 1946.
  43. "Noise in Resistances and Electron Streams," J. R. Pierce, Bell System Tech. Jour., Jan. 1948.

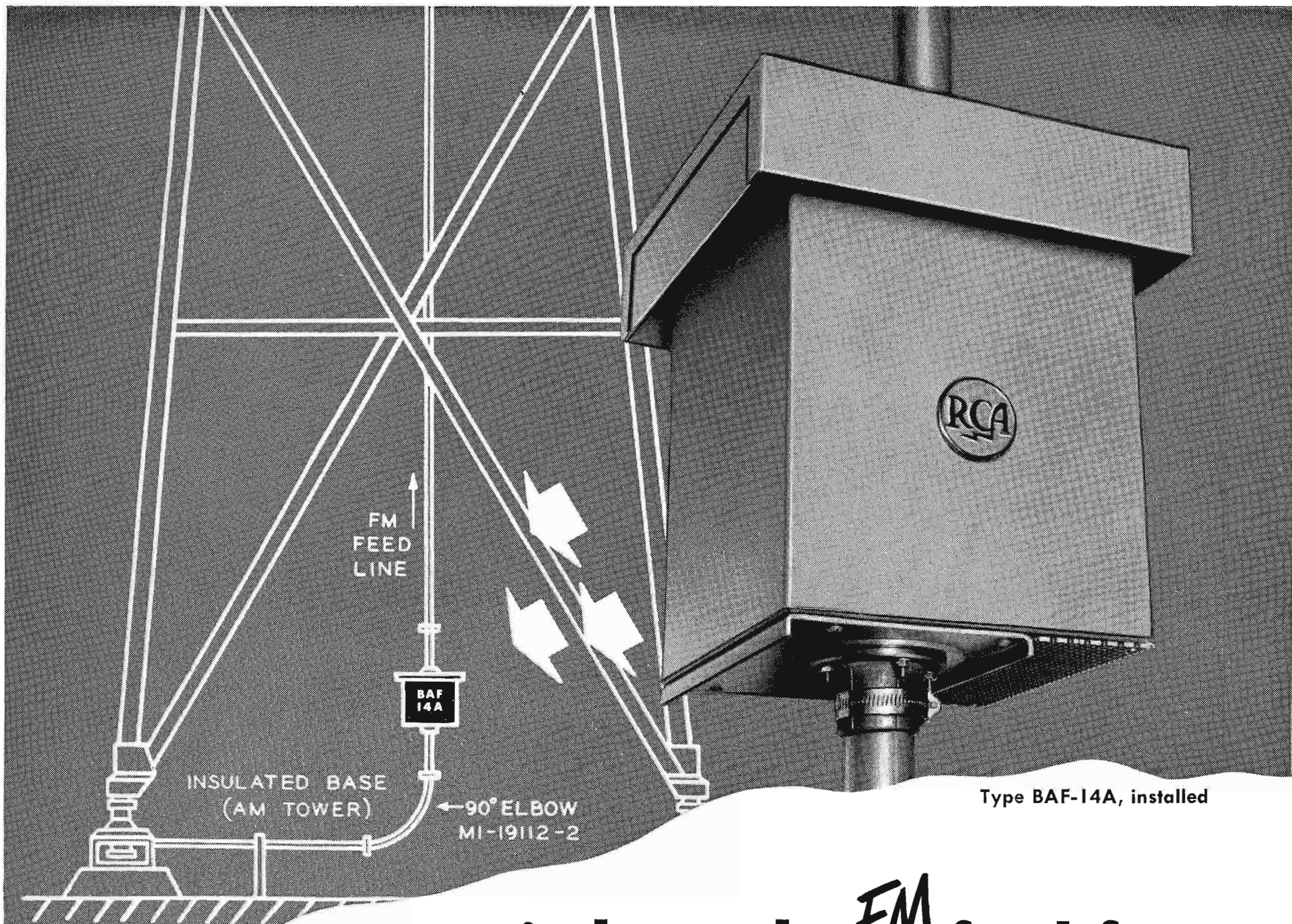

Type BAF-14A, installed

...isolates the **FM** feed from  
 your **AM** tower ...*the easy way*

Close-up view of the BAF-14A  
 with the shield removed.

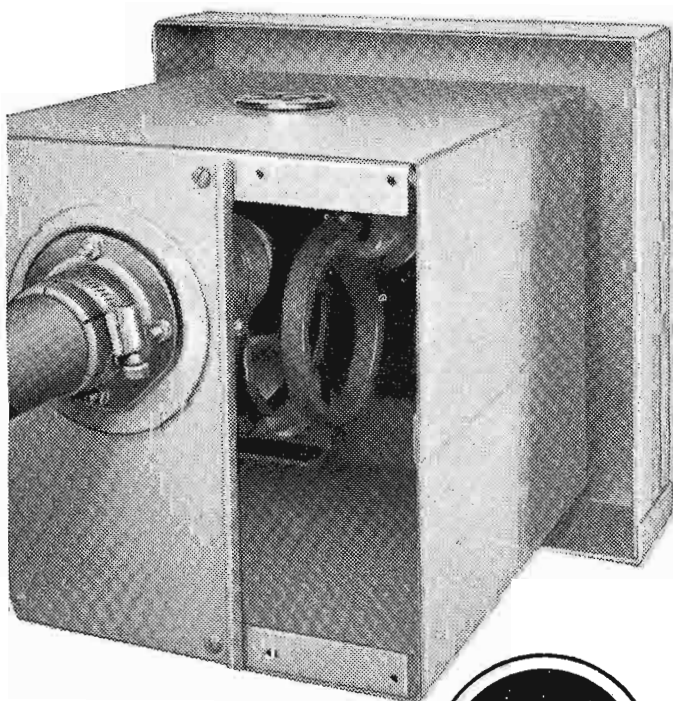

**New design—New low price\***

• The new RCA Type BAF-14A Isolation Unit enables you to transfer FM power effectively across the insulating zone of your AM tower . . . and makes it possible to completely isolate the FM and AM signals from each other. The unit maintains a low standing wave ratio on any FM channel and has minimum effect on AM tower impedance. Type BAF-14A will handle up to 10 kilowatts of FM power—with AM base insulator voltages up to 14 kv, peak!

In this Isolation Unit, two series-resonant circuit loops are coupled to each other in such a way as to provide excellent band-pass characteristics over the range of 88 to 108 Mc. Each circuit connects directly to its respective input or output transmission line—terminating

in an end-seal. Provision is made to carry the gas pressure line across the unit.

It's a simple matter to connect up the BAF-14A . . . because the input and output terminals are both equipped with special swivel flanges that eliminate expensive special coaxial fittings.

Built in a weatherproof metal box, only 12" x 12", the BAF-14A Isolation Unit is delivered ready to go. No tuning or adjustments to go through after installation.

Ask your RCA Broadcast Sales Engineer how the BAF-14A can solve your tower coupling problem. Or write Dept. 19FA, RCA Engineering Products, Camden, N. J.

\*Ask your Broadcast Sales Engineer



**BROADCAST EQUIPMENT**  
**RADIO CORPORATION of AMERICA**  
**ENGINEERING PRODUCTS DEPARTMENT, CAMDEN, N.J.**

In Canada: RCA VICTOR Company Limited, Montreal

# Everything for TV

328

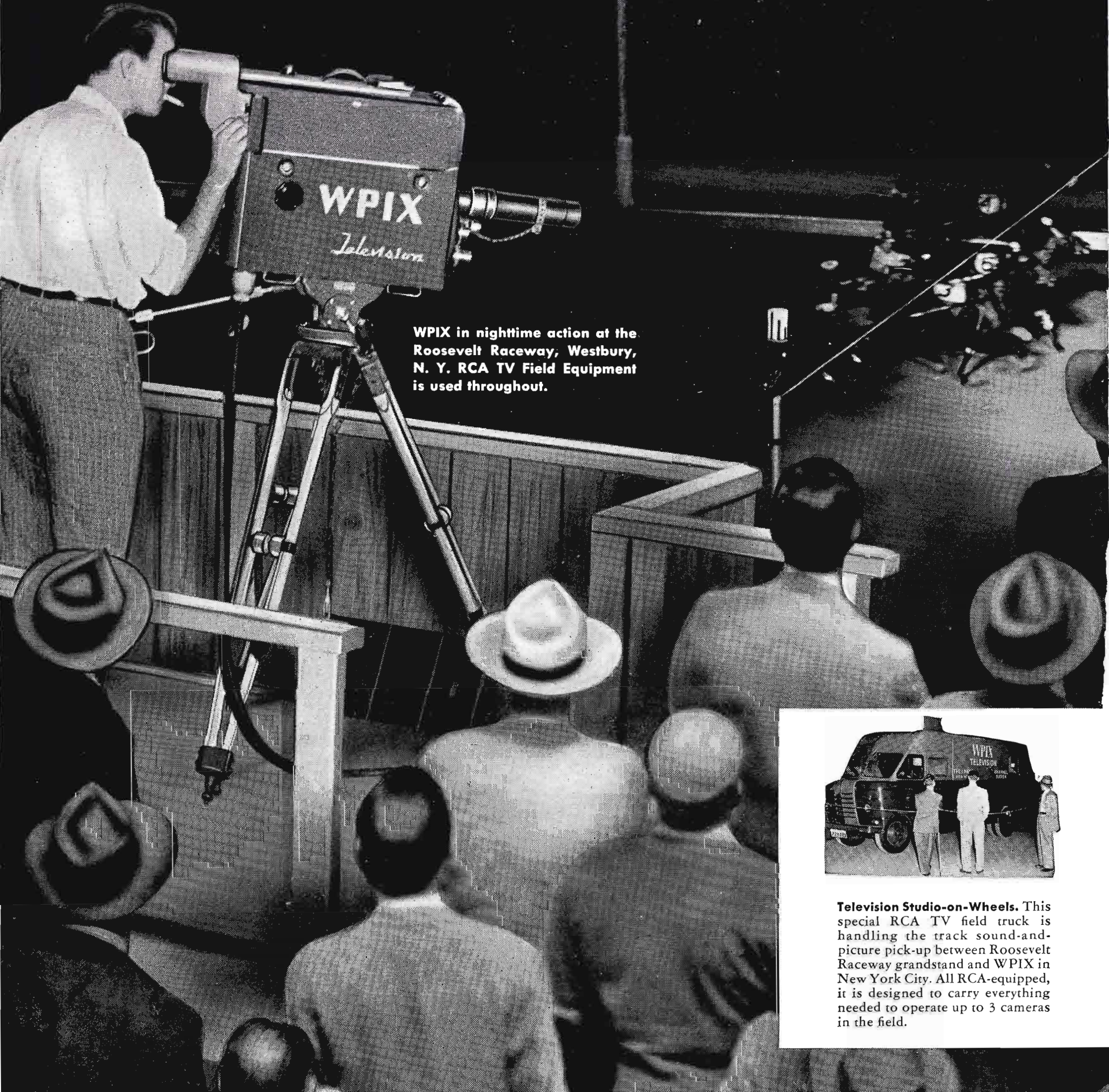

WPIX in nighttime action at the Roosevelt Raceway, Westbury, N. Y. RCA TV Field Equipment is used throughout.

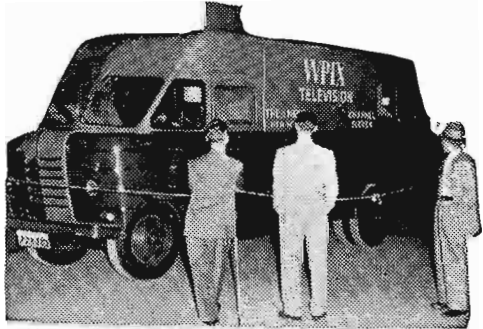

**Television Studio-on-Wheels.** This special RCA TV field truck is handling the track sound-and-picture pick-up between Roosevelt Raceway grandstand and WPIX in New York City. All RCA-equipped, it is designed to carry everything needed to operate up to 3 cameras in the field.

# ... complete field equipment,

*for instance —*

● That exciting finish you see is being covered by television field equipment, all-RCA from camera to microwave relay antenna.

Thoroughly practical for quick, on-the-spot pick-ups, this highly compact and portable equipment is designed to handle outdoor telecasting under all sorts of conditions. Complete pick-up and relay equipment includes: two image orthicon cameras (with telephoto lens); camera tripods; camera control units; on-the-air master monitor; camera switching system; synchronizing generator; microwave relay equipment; associated power supplies; reels of cable—all carried in one special truck.

Why this preference for RCA field equipment among the majority of TV stations now in operation?

Because RCA TV Field Equipment has been worked out by television experts who know

the business. All gear, for example, is completely portable and subdivided into small units for easy handling. All field cameras are equipped with 4-position turret lens and electronic view finders. There are complete switching facilities that help the operators deliver faster-moving shows. And there is a special truck that carries the equipment to location... with all the facilities required to run most of the equipment *right from the vehicle itself*. No wires needed to get the picture signals back to the station. High-efficiency microwave radio relay does it—airline!

Overlook none of the technical and economical advantages of correct initial station planning. Your RCA Television Specialist can help. Call him. Or write Dept. 1900 RCA Engineering Products, Camden, New Jersey.



**TELEVISION BROADCAST EQUIPMENT**  
**RADIO CORPORATION of AMERICA**  
**ENGINEERING PRODUCTS DEPARTMENT, CAMDEN, N.J.**

In Canada: RCA VICTOR Company Limited, Montreal

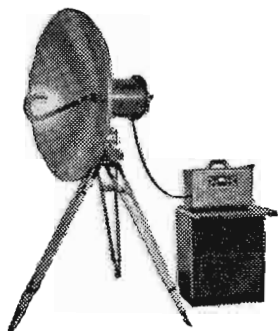

**RCA Microwave Relay Transmitter TTR-1A.** Transmits the picture signals from field to studio (or from studio to transmitter). It includes a parabolic antenna with hook-shaped wave guide, built-in transmitter, and remote control unit. Matching receiver unit at the station picks up the microwave relay signal.

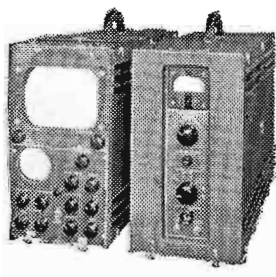

**RCA Field Camera Control TK-30A.** For monitoring the picture and controlling its quality. Unit No. 1 includes one 7" picture monitor tube and one 3" oscilloscope (to observe video signal waveform). Unit No. 2 is the power supply.

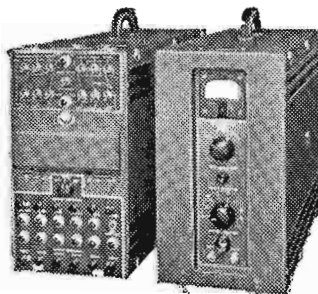

**RCA Field-Switching System TS-30A.** Nerve center of TV field pick-up operations. Switches intercom circuits and picture signals between cameras and monitor. Unit No. 1 provides for video switching, sync signal insertion, and master monitor switching. Unit No. 2 is the power supply.

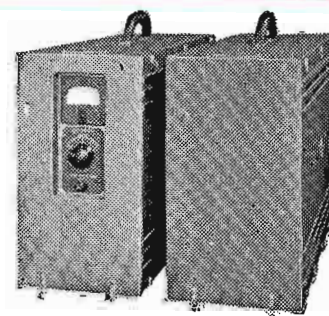

**RCA Field Synchronizing Generator TG-10A.** Produces timing pulses for TV field equipment. Unit No. 1 includes pulse-forming circuits, frequency-control circuits, and power supply. Unit No. 2 includes the pulse-shaping and output circuits.

# Everything for TV—

## entire studios, for instance...

● Action in this TV studio is being covered by picture-and-sound pick-up units—all RCA. Just one combination, this, among dozens of different studio equipment arrangements now being delivered to more than 50 of the nation's leading television stations.

As workable and versatile, we believe, as the pick-up equipment in any motion-picture studio, this set-up has the electrical and mechanical facilities required to handle any show in the station—and with the same professional results. It includes two studio cameras using the new studio-type RCA image orthicon pick-up tube—with one camera mounted on a new crane-type dolly, and one camera mounted on a pedestal-type dolly. It includes a high-fidelity microphone, and a special-type microphone boom to follow the action swiftly.

Good reason why RCA studio equip-

ment is tops with so many TV station men.

RCA TV studio equipment is integrated to work together like the mechanism in a watch. RCA TV studio equipment is uniquely versatile. It can be used in any combination by any station, large or small. It can be supplemented by additional units—without doing away with the initial equipment. RCA TV studio equipment produces sharper picture contrast with great depth of focus—and with less expensive lighting. RCA TV studio equipment is designed and built by a company well-known in the industry for its *continued* interest in the performance of the equipment—after it's in your station.

Why not let an RCA Television Specialist help you plan your TV station? Call him in. Or write Dept. 19KC, RCA Engineering Products, Camden, New Jersey. No charge. No obligation.

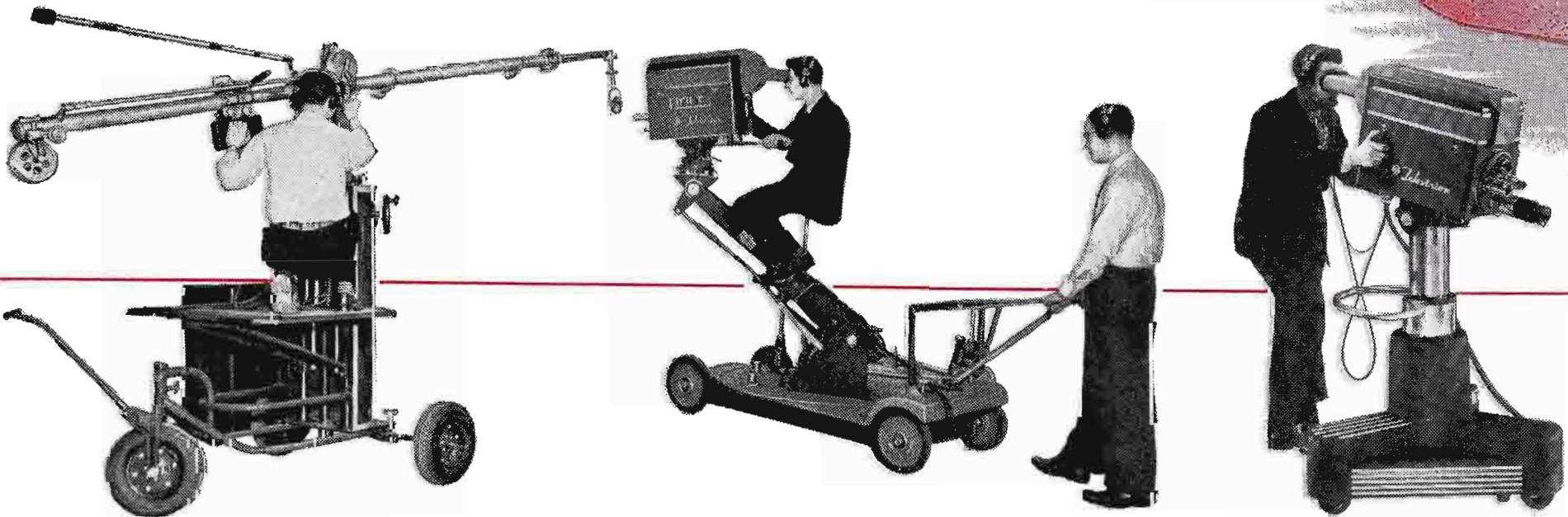
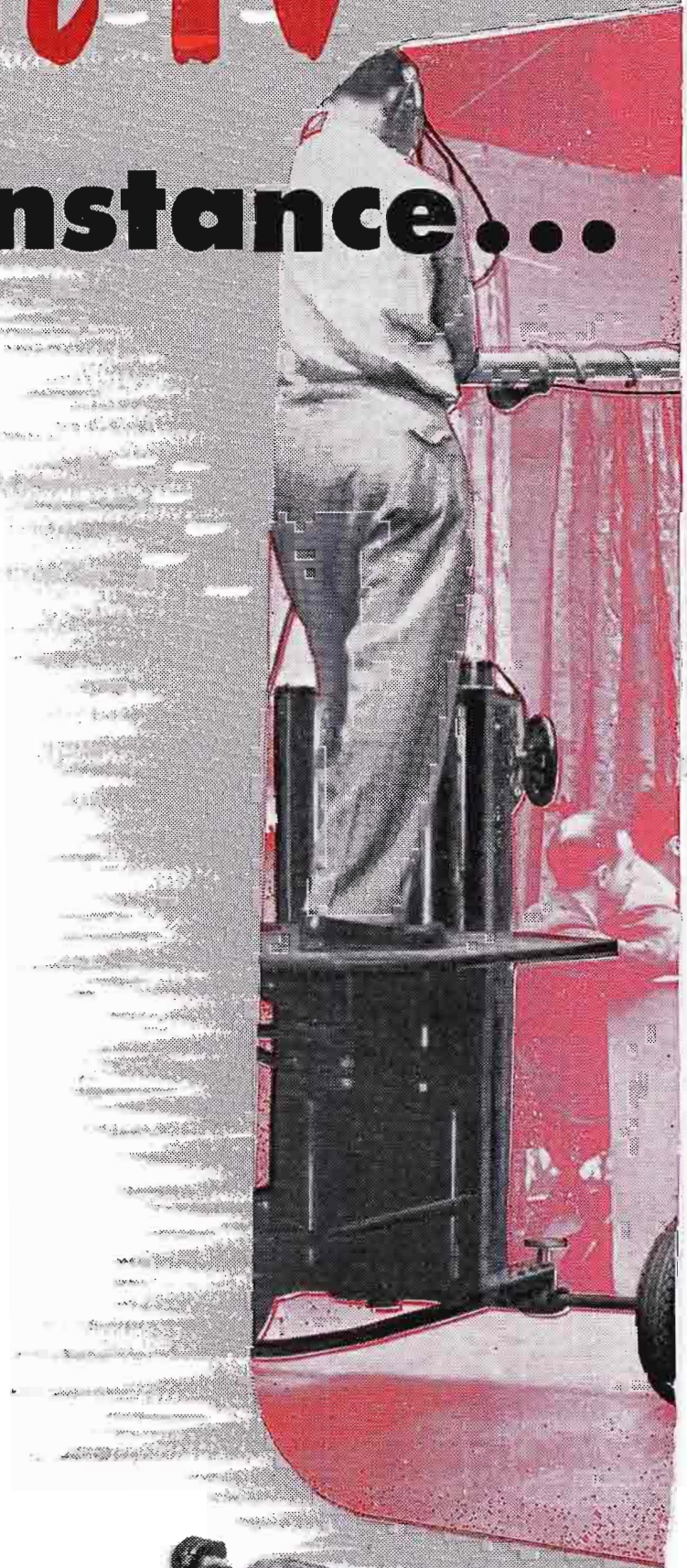

**RCA Studio Microphone Boom, Type MI-26574.** The same type of boom as used in motion-picture studios. A counterbalanced, telescoping arm . . . controlled from the base . . . extends the microphone to any desired position to keep it out of the camera's view. A manual control at the base rotates the microphone for the desired pick-up.

**RCA Studio Dolly, Type MI-26040.** This crane-type portable dolly enables the camera man to move in and out—add variety to otherwise static scenes. The camera is lowered and raised manually. The entire assembly rotates horizontally around its base. This dolly can be silently transported around the studio while the camera man focuses the scene.

**RCA Studio Pedestal, Type MI-26035.** Lowers and raises camera manually—rolls quietly, steers readily by means of a circular handle around the pedestal base. RCA Friction Head, type MI-26205, provides horizontal panning action and a vertical tilting movement—lock-holds the camera in any position. The camera includes the intercommunication circuits.



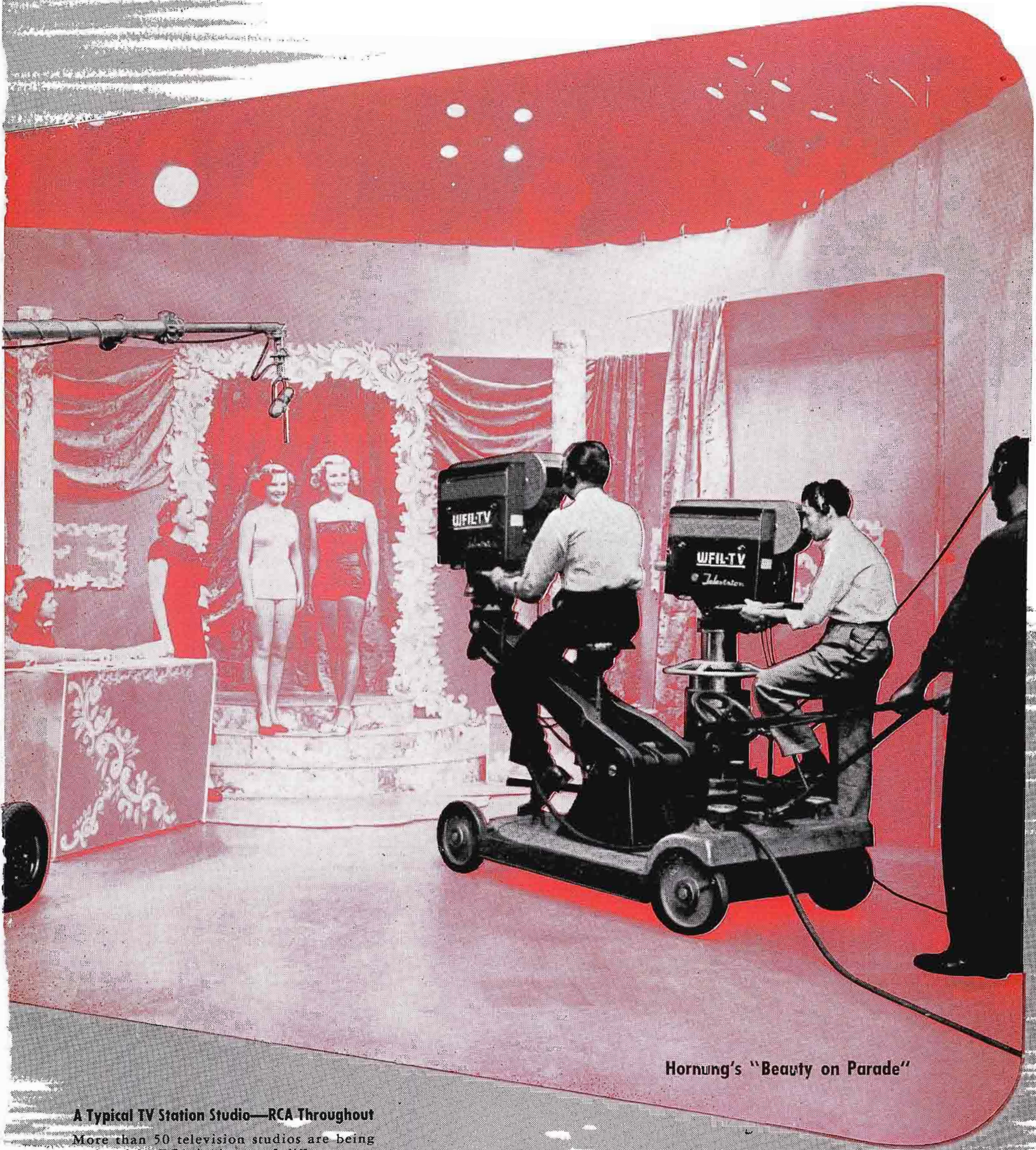

Hornung's "Beauty on Parade"

**A Typical TV Station Studio—RCA Throughout**

More than 50 television studios are being equipped by RCA in dozens of different combinations to fit individual station needs and budgets. Professional performance—with perfect picture-and-sound pick-ups every time.



**TELEVISION BROADCAST EQUIPMENT**  
**RADIO CORPORATION of AMERICA**  
**ENGINEERING PRODUCTS DEPARTMENT, CAMDEN, N. J.**

In Canada: RCA VICTOR Company Limited, Montreal

# Everything for TV...

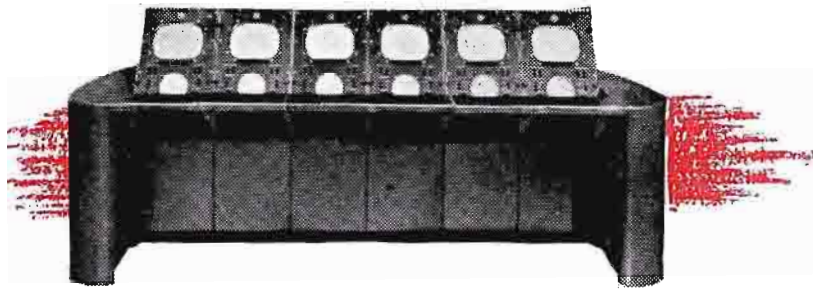

**RCA De Luxe Video Console.** Everything you need to monitor, control, and switch camera pictures. "Add-a-unit" design enables you to expand these facilities as your station grows.

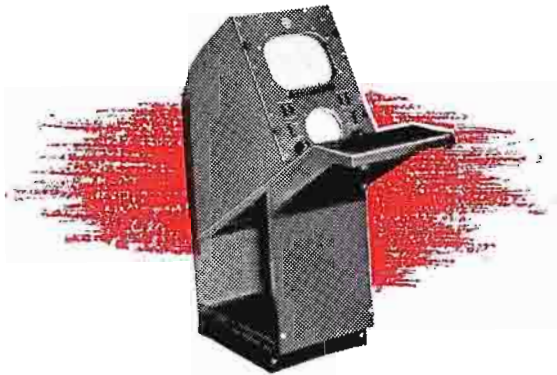

**RCA Camera Control Type TK-10A.** Makes it practical to watch and control the picture quality of station camera. Same size and appearance as RCA's switching units, film camera control, and preview- and line-monitoring units. These units can be grouped in any combination to form a video console (shown above).

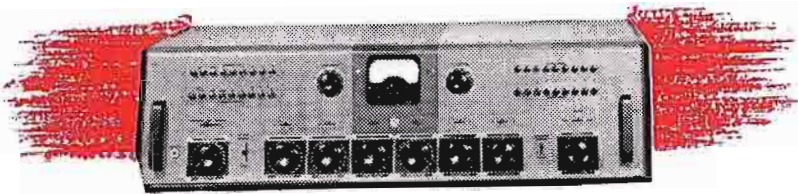

**RCA Studio Consolette Type 76-C4.** This flexible and easy-to-operate control unit performs all the audio amplifying, monitoring, and control functions of a TV station—large or small. Can be used for single- or two-studio operation, and for two transcription turntables.

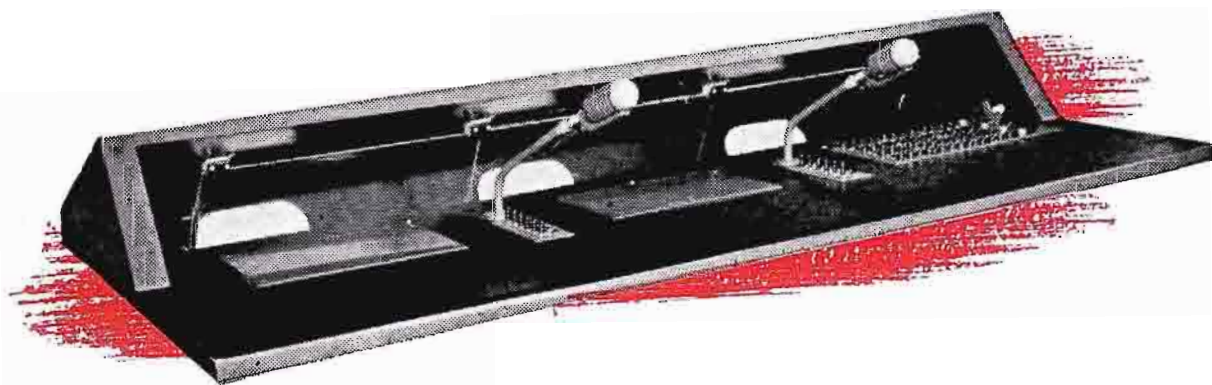

**RCA Program Directors Console Type TC-5A.** Television's most up-to-date directors' control. Includes large-size picture monitors for the studio outgoing line, for previewing, and for "on-the-air" monitoring. All switching under finger-tip control. Low height for full studio visibility. Recessed monitors for maximum image brightness in a fully-lighted control room.

**T**HAT PICTURE you see over there is a studio control room for a medium-size television station—complete by RCA, from sight to sound.

This room virtually puts entire programming under "push-button" supervision. From here you control and monitor studio programs . . . sound and picture . . . switch between *all* cameras, switch to network or remote programs, control and monitor recorded sound, monitor the programs on the air.

In this room are large picture monitors for previewing signals from remotes or networks and from the studio cameras. In this room also is an audio consolette that controls all program sound lines—from the studio microphones, network audio line, studio and announce microphones, and from the turntables shown in the foreground. A program console . . . with its picture monitor for viewing the studio line and the on-the-air picture . . . co-ordinates the programming. Nothing included in this room that should not be there. Nothing omitted that should be included.

Why do most TV stations go RCA all the way on studio control-room equipment?

Because RCA control-room equipment has design flexibility to meet every station's need and budget. Because RCA control-room equipment is *unit-built* . . . permits easy and economical addition of extra units without a worry about discarding the original equipment. Because a single company makes the entire line . . . *and backs it up!*

For professional assistance in planning your television station, call in an RCA Specialist. Or write Dept. 19 FD, RCA Engineering Products, Camden, N. J.

# entire studio control rooms, *for instance*

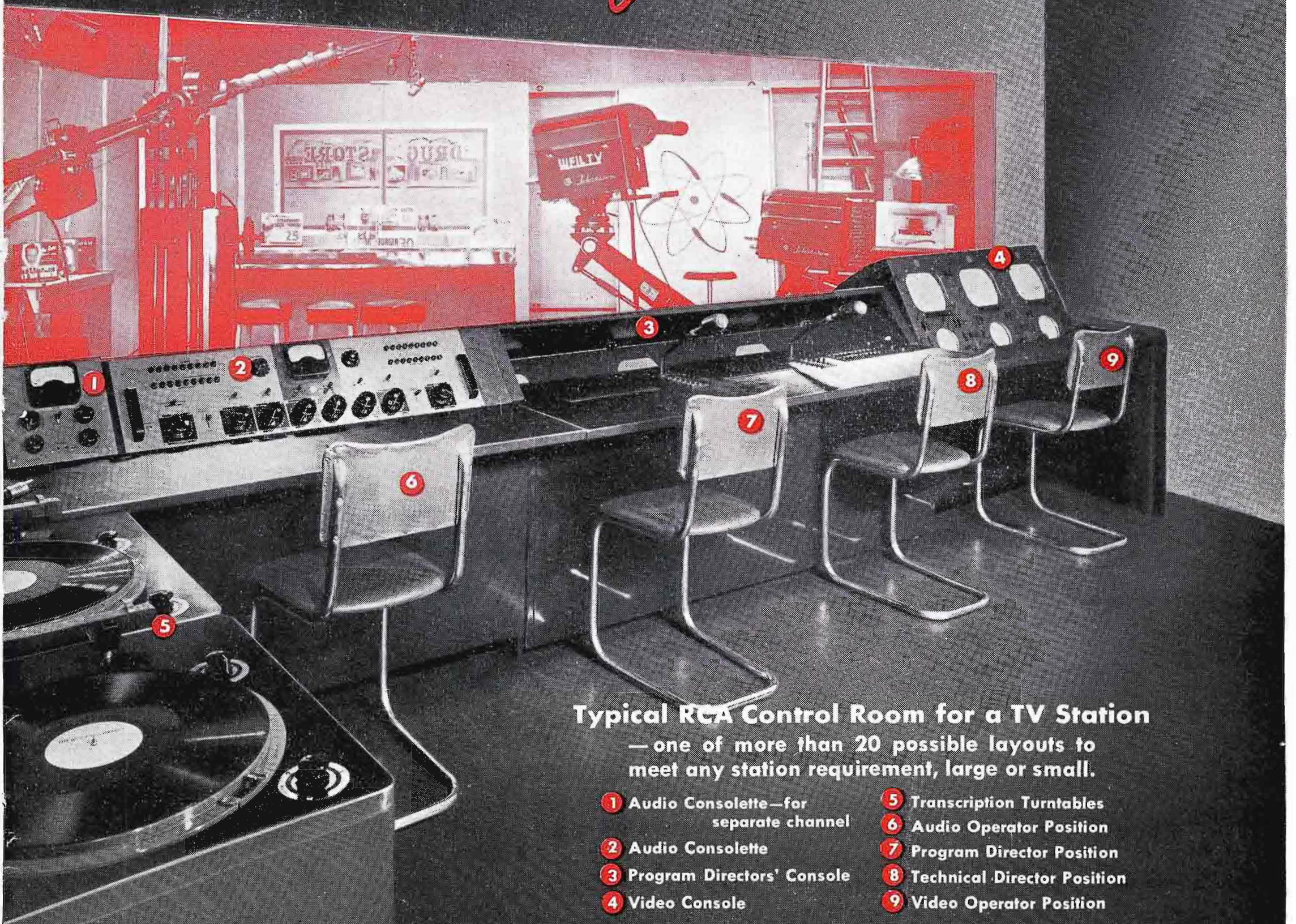

**Typical RCA Control Room for a TV Station**  
— one of more than 20 possible layouts to meet any station requirement, large or small.

- |   |                               |
|---|-------------------------------|
| 1 Audio Consolette—for separate channel | 5 Transcription Turntables    |
| 2 Audio Consolette                      | 6 Audio Operator Position     |
| 3 Program Directors' Console            | 7 Program Director Position   |
| 4 Video Console                         | 8 Technical Director Position |
|   | 9 Video Operator Position     |



**TELEVISION BROADCAST EQUIPMENT**  
**RADIO CORPORATION of AMERICA**  
**ENGINEERING PRODUCTS DEPARTMENT, CAMDEN, N.J.**

In Canada: RCA VICTOR Company Limited, Montreal

# Everything for TV...

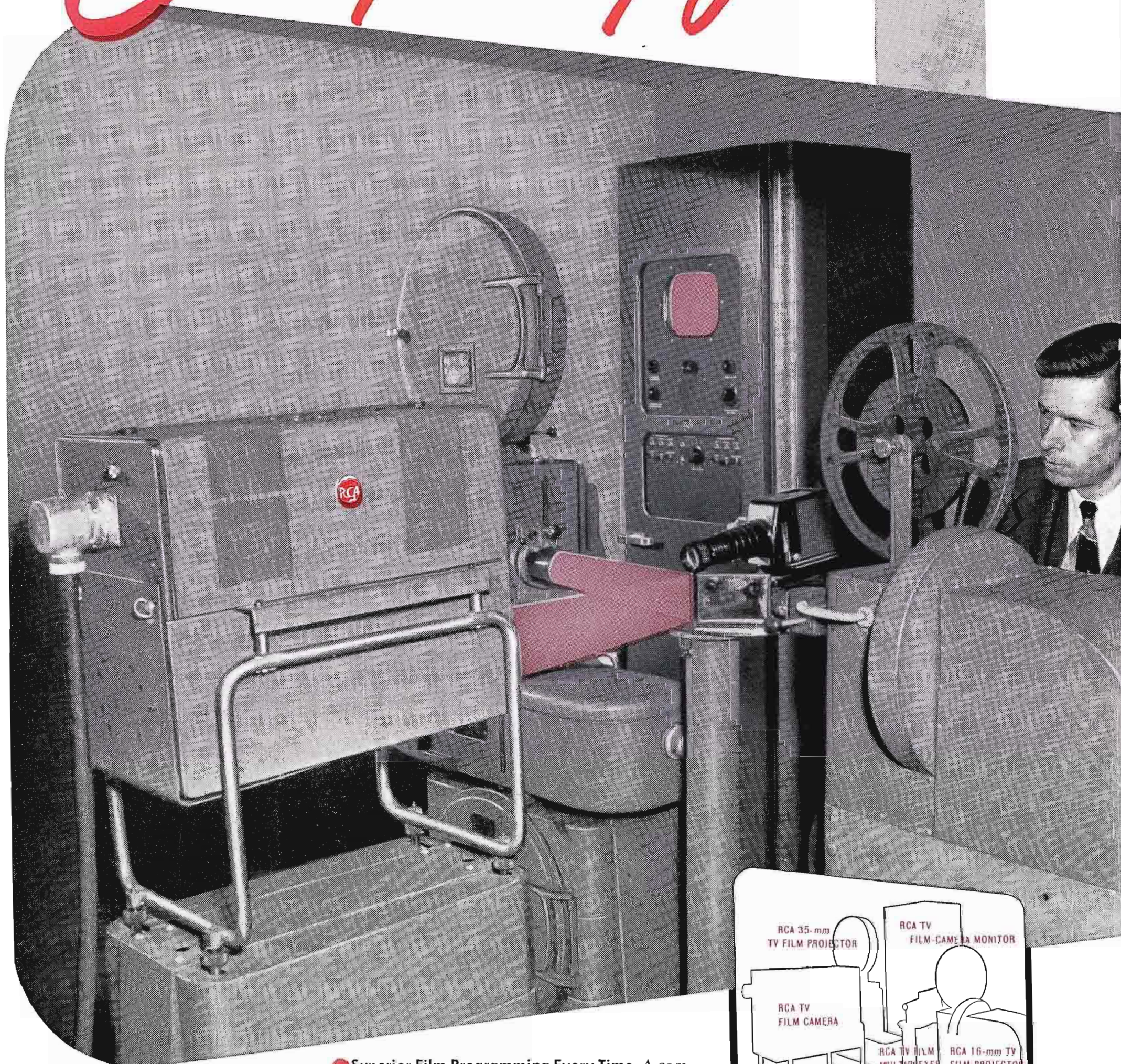

● **Superior Film Programming Every Time.** A completely equipped TV film-projection room by RCA —one of nearly 10 different combinations now being delivered to more than 50 television stations throughout the country.

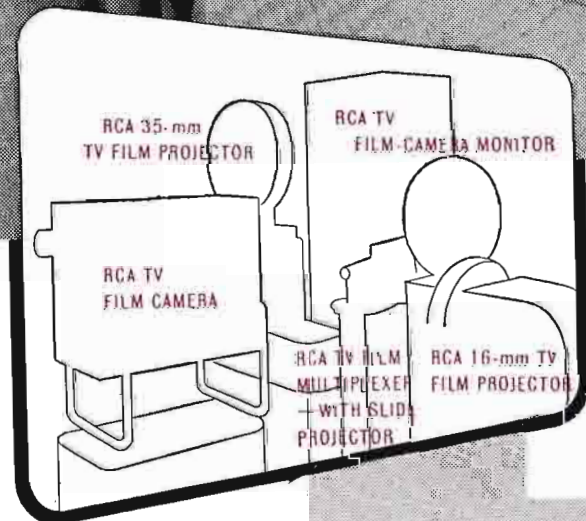

# entire film-projection rooms,

*for instance —*

**Y**OU are looking at a complete film projection room for a typical small television station—one of nearly ten different “all-RCA” combinations now being delivered to more than fifty stations throughout the country.

As reliable and practicable as the projection room of a modern theatre, this simple, integrated equipment is designed to handle film program material of every description—station identification slides, newsreels, commercial announcements, shorts, feature films, cue-ins for live-talent shows, etc. *And one operator can run it!*

All-RCA from floor to ceiling, the installation includes everything needed to produce bright, flickerless, dependable television pictures: A TV film camera; A new 35-mm film projector; A 16-mm film projector; A multiplexer for using two projectors with *one* film camera; and rack-mounting power supplies, amplifiers, and monitor. Projector switching for the entire room is under finger-tip control from the room itself—or from the studio control room.

Why the extraordinary acceptance of RCA film projection equipment by more than 50 television stations?

Because all RCA projection units are unified and designed to work together in any combination... enabling each station to select just the proper units for its special needs and budget. Because RCA makes it practical for a station to start small and add projection units as it grows—without discarding any of the original equipment. Because RCA makes everything required in a television film-projection room—and accepts complete responsibility for the over-all performance of the equipment. Because each station layout is planned *correctly from the start*, by television experts who understand the business thoroughly.

• • •

No need for expensive experiments with your own film-projection room... if you let an RCA Television Specialist help you with the planning. Call him. Or write Dept. 19 JA, RCA Engineering Products, Camden, New Jersey.



**RCA Multiplexer, Type TP-9A.** Produces uninterrupted projection of multi-reel films with only *one* film camera. Complete, with slide projector for station breaks, commercials, etc.

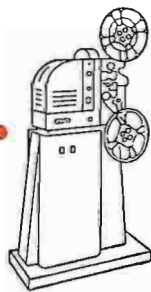

**RCA 16-mm Film Projector, Type TP-16A.** Popular low-cost projector. Self-contained. Simple. Low cost. Enables *any* station to use the film programming now available. Produces brilliant pictures and high-quality sound.

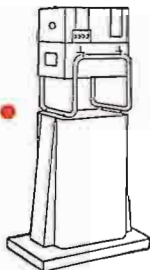

**RCA Film Camera, Type TK-20A.** A high-contrast film camera having unusual stability. It is used with either 16-mm or 35-mm film projectors, and slide projectors.

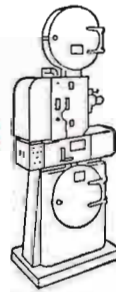

**RCA 35-mm Film Projector, Type TP-35A.** Projects sharp, flickerless pictures—and high-fidelity sound. Brilliant light output with negligible heating of film and film gate. Can project single frames as stills.



**RCA Film Camera Monitor Rack.** This is the control center of the projection room. It houses the amplifiers, all necessary rack-mounted power supplies, and the kinescope for viewing the film pictures.



**TELEVISION BROADCAST EQUIPMENT**  
**RADIO CORPORATION of AMERICA**  
**ENGINEERING PRODUCTS DEPARTMENT, CAMDEN, N. J.**

In Canada: RCA VICTOR Company Limited, Montreal

# Everything for TV

RCA EQUIPMENT CABINETS for small rack-mounting units, such as monoscope camera, studio line amplifiers for sound and picture, microwave relay receiver, test equipment, power supplies, etc.



RCA DUMMY LOAD. For testing and measuring power output. This unit consists of a coaxial line, the inner conductor of which is a water-cooled resistor.

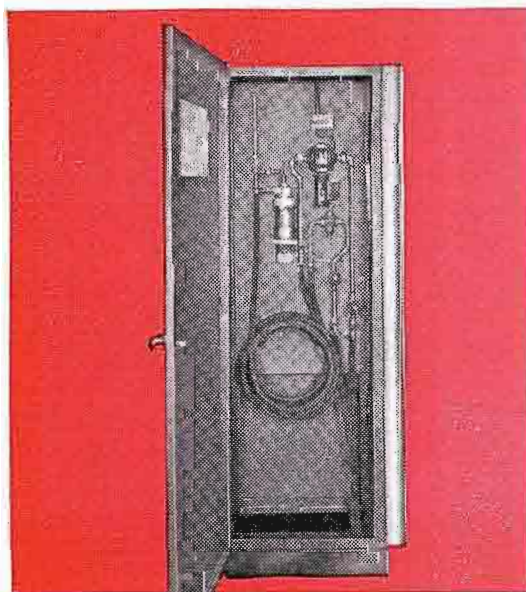

L-F ANTENNA DIPLEXER (left) AND THE VESTIGIAL SIDE-BAND FILTER (right). Diplexer makes it practical to use one antenna for picture-and-sound signals. Side-band filter partially suppresses one sideband. No adjustments required.

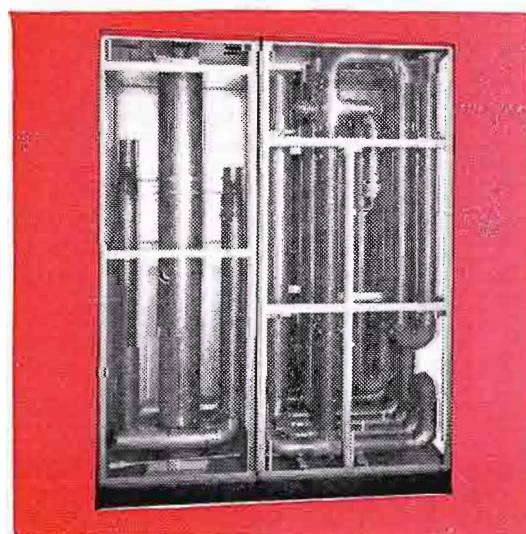

You see here the transmitter room that is *being delivered to more than thirty television stations . . .* complete, and RCA throughout.

As practical, we believe, as an AM station transmitter room, this layout has the proper equipment you need to put high-quality picture-and-sound signals on the air—reliably, and with surprisingly little supervision. It includes: a combined 5-kw picture and 2.5-kw FM sound transmitter; a complete transmitter control console; a vestigial side-band filter; a dummy load; an antenna coupling network; sound-and-picture input antenna coupling network; sound-and-picture input amplifiers; and frequency and modulation monitors.

Why the overwhelming acceptance for this transmitter room . . . and all other RCA television equipment?

It's the *thoroughness* with which RCA TV equipment is designed. It's the *practical engineering* experience behind it—more of it than any other television equipment manufacturer. It's the *completeness of the line . . .* with one equipment source for everything you need in your station. It's the undivided *responsibility* RCA assumes for all equipment you buy. It's the unbroken *record of past performance and service* to the industry.

Nothing to planning a television station—when you let an RCA Television Specialist help you. Call him in. Or write Dept. 19, RCA Engineering Products Division, Camden, N. J.

RCA CONTROL CONSOLE for "push-button" control of your transmitter room. Handles both picture and sound transmitters, a turntable, and an announce microphone. Includes power switches, picture and sound monitors, switching circuits, antenna current meters—and an oscilloscope.

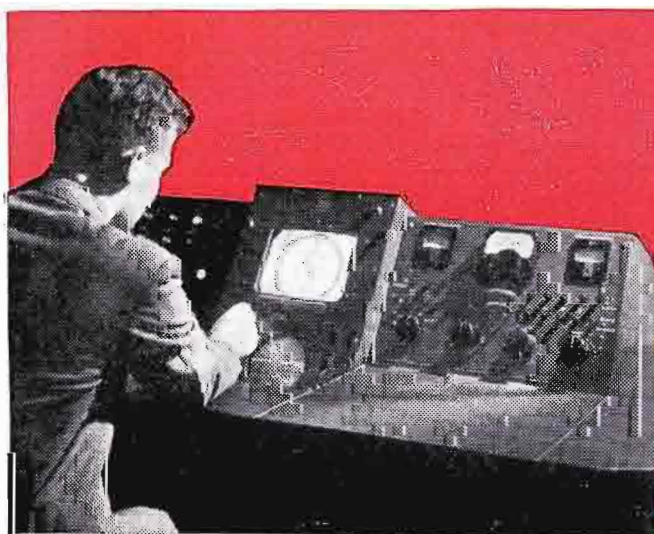

THE RCA 5-KW TV TRANSMITTER (plus 2.5 kw for FM sound). Full picture-and-sound power on your channel. High-level modulation. Meter-tuned, narrow-band drivers. Only one class B stage to adjust. No neutralizing of PA. Built for "walk-in." Delivery being made to more than 30 stations.

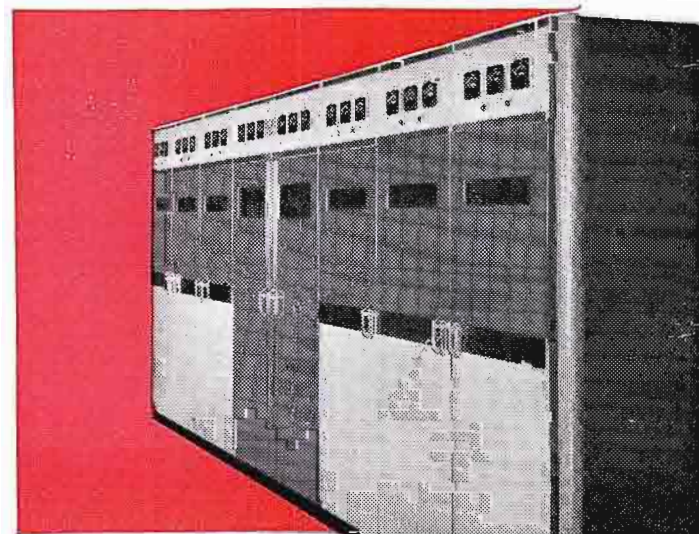

...entire transmitter rooms,  
*for instance —*

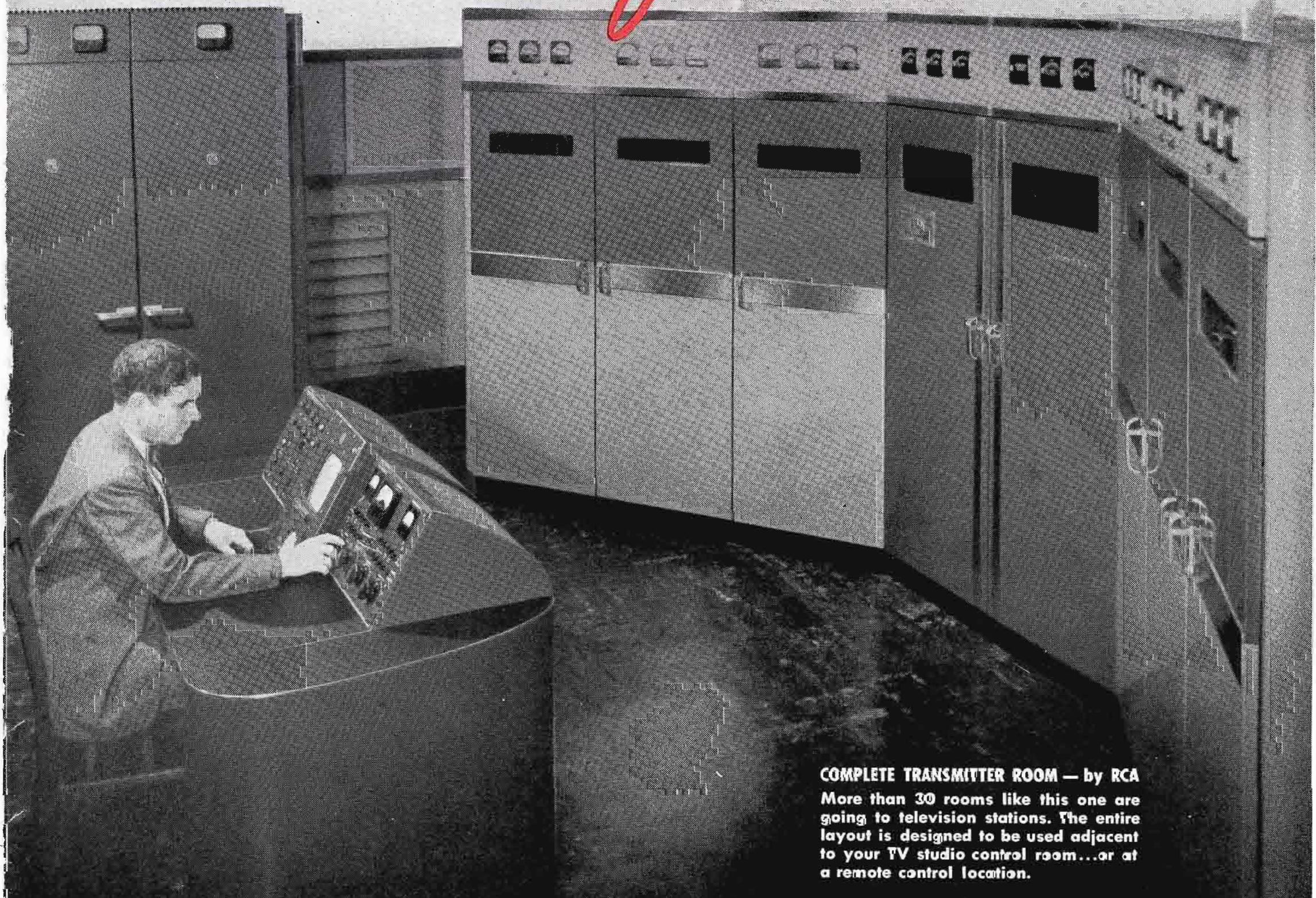

**COMPLETE TRANSMITTER ROOM — by RCA**  
More than 30 rooms like this one are going to television stations. The entire layout is designed to be used adjacent to your TV studio control room...or at a remote control location.



**TELEVISION BROADCAST EQUIPMENT**  
**RADIO CORPORATION of AMERICA**  
**ENGINEERING PRODUCTS DEPARTMENT, CAMDEN, N.J.**

In Canada: RCA VICTOR Company Limited, Montreal

# Everything for TV-

## complete antenna systems,

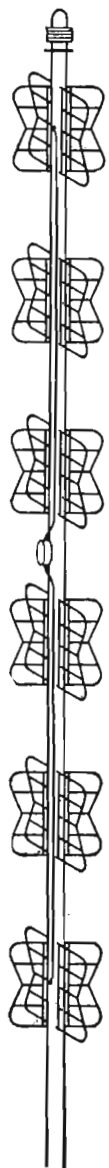

● Up there, 737 feet above the sidewalks, is a 6-section Super Turnstile—RCA complete from transmission line to beacon light. More than sixty RCA TV antennas of this bat-wing type have been shipped to television's top stations. Many are now in use.

Each RCA Super Turnstile is complete—with everything needed to transmit high-quality sound-and-picture signals. A complete system includes a Diplexer for handling sound and picture signals simultaneously, transmission lines, de-icing equipment, 300-mm beacon, and all miscellaneous hardware. The system can also include a Triplexer (optional) for operating your present FM transmitter and your new television sound-and-picture transmitter . . . *simultaneously on the one antenna.*

Why are RCA Super Turnstiles the choice of nearly 90 per cent of the TV stations?

Because RCA Super Turnstiles produce a horizontal radiation pattern that is virtually circular. They provide power gains of 3.5 to 7.1, depending on the TV channel used. (For example, Type TF-3A antenna delivers an effective radiated power of over 20 kilowatts with a 5-kw transmitter on channel 6.) RCA Super Turnstiles are lightweight, have low wind resistance, are effectively grounded for lightning protection, and are easy to erect.

Get the proper start in planning your antenna system . . . and your station . . . by calling in your RCA Television Specialist. Or write Department 19LE, RCA Engineering Products, Camden, New Jersey.

**Six-section RCA TV Super Turnstile Antenna, Type TF-6.** This single unit can be mounted on building or tower. Total weight, only 2,300 lbs. Height, 46 feet, 3 inches. Power gain, 6.4-7.1 on channels 7 to 13.

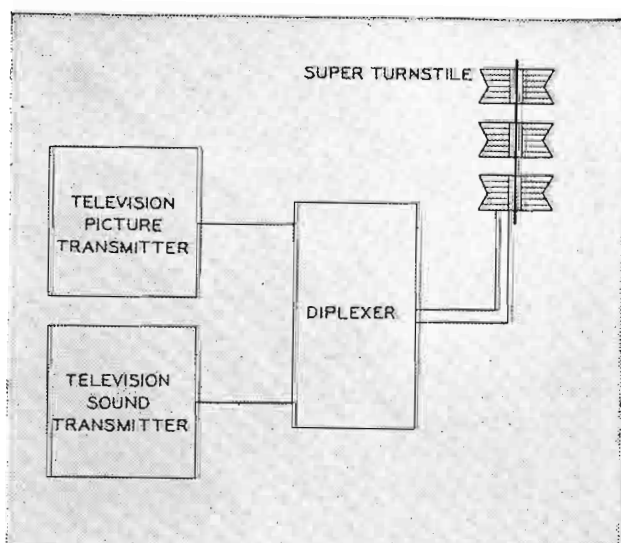

### For the Separate TV Station

The RCA Diplexer feeds both the sound-and-picture signals—minimizing interaction in the transmitters so that one antenna radiates both signals simultaneously and effectively.

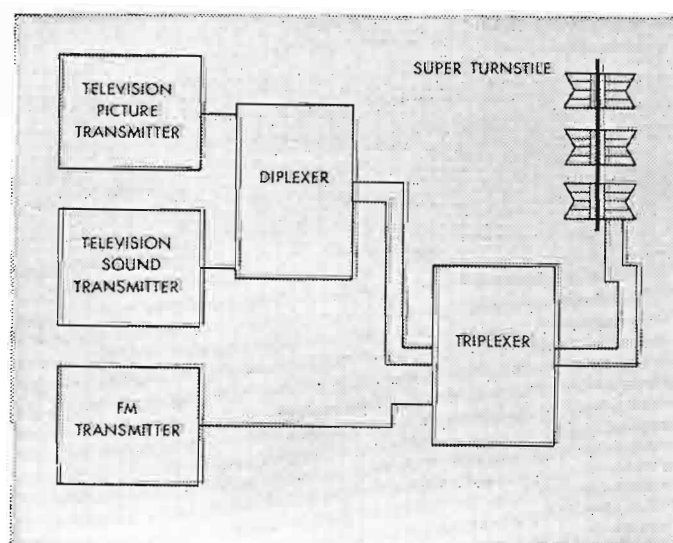

### For the Combination TV-FM Station (Certain powers and channels only)

Enables the station to use FM in the 98-108 Mc band while simultaneously transmitting TV pictures and sound. Diplexer and triplexer isolate all three transmitters and feed their signals to the one antenna. Here, *one RCA Super Turnstile does it!*

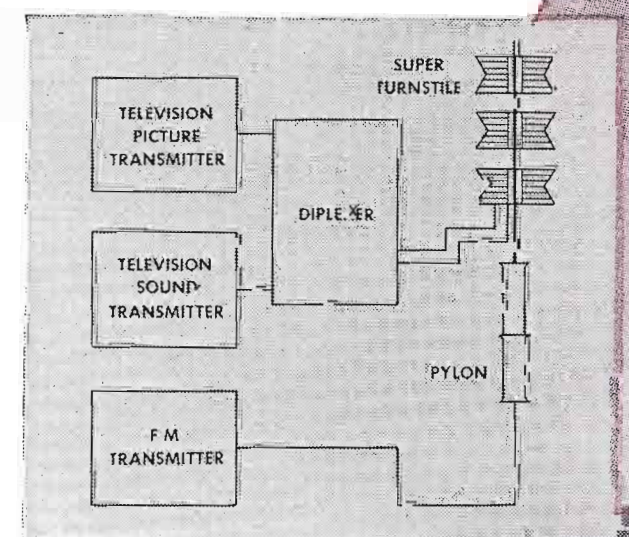

### For the Combination TV-FM Station (All powers and channels not covered by 2)

A Super Turnstile with Diplexer, for the TV sound-and-picture signals; and an FM Heavy-Duty Pylon for the separate FM transmitter. Here, *one RCA antenna system does it!*



**for instance**

WCAU-TV Philadelphia, on channel ten, uses an RCA 6-section TV Super Turnstile atop an RCA FM Heavy-Duty Pylon antenna. Here you see two antennas on a single self-supporting tower.

TELEVISION BROADCAST EQUIPMENT  
**RADIO CORPORATION of AMERICA**  
ENGINEERING PRODUCTS DEPARTMENT, CAMDEN, N.J.

In Canada: RCA VICTOR Company Limited, Montreal



**RCA Field-Intensity Meter**  
**Type WX-1A**  
**50 to 220 Mc**



**NEW** *field-intensity meter*

**—for the television and FM bands**

**SPECIFICATIONS**

- Freq. Range . . . . . 50 to 220 Mc
- Sensitivity . . . . . 5 microvolts to  
20 microvolts/meter,  
depending on frequency
- I-F Bandwidth . . . . . 150 kc
- FM Adjacent Channel  
Selectivity . . . . . 65 to 1
- FM Band Image Ratio . . 130 to 1
- Power Supply . . . . . Built-in 6-v,  
voltage-regulated  
(a-c power supply  
also available)
- Weight  
Meter . . . . . 43½ lbs.  
Antenna  
(including tripod) . . . . 15 lbs.
- Size . . . . . 19" L x 14½" H x 13" D

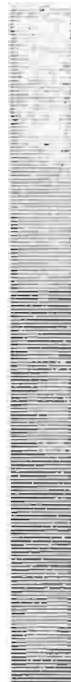

THE WX-1A meets the strict requirements of FM and TV engineers for a field-intensity meter of laboratory accuracy covering television, FM, and AM services between 50 and 220 Mc. Its high sensitivity permits minimum readings ranging from as low as 5 microvolts per meter at 50 Mc, to 20 microvolts per meter at 200 Mc.

Completely self-contained, the WX-1A includes a very stable superheterodyne receiver. Selectivity characteristic is down 65 to 1 on adjacent FM channels. Image ratio is 130 to 1 at 100 Mc. A 2-stage audio amplifier drives a built-in loudspeaker for continuous audio monitoring of the signals being measured.

Separate output terminals provide for convenient use with the standard Easterline-Angus recorder. The built-in vibrator power supply includes its own voltage regulator. The antenna . . . furnished with each WX-1A...is adjustable for horizontal or vertical polarization.

For accurate data on the service area of any TV, FM, or AM station in the uhf—and for authoritative coverage information for FCC proof-of-performance—the WX-1A is second to none. Complete details are available from your RCA Broadcast Sales Engineer. Or from Dept. 191B, RCA Engineering Products, Camden, N. J.



**BROADCAST EQUIPMENT**  
**RADIO CORPORATION of AMERICA**  
**ENGINEERING PRODUCTS DEPARTMENT, CAMDEN, N.J.**

In Canada: RCA VICTOR Company Limited, Montreal

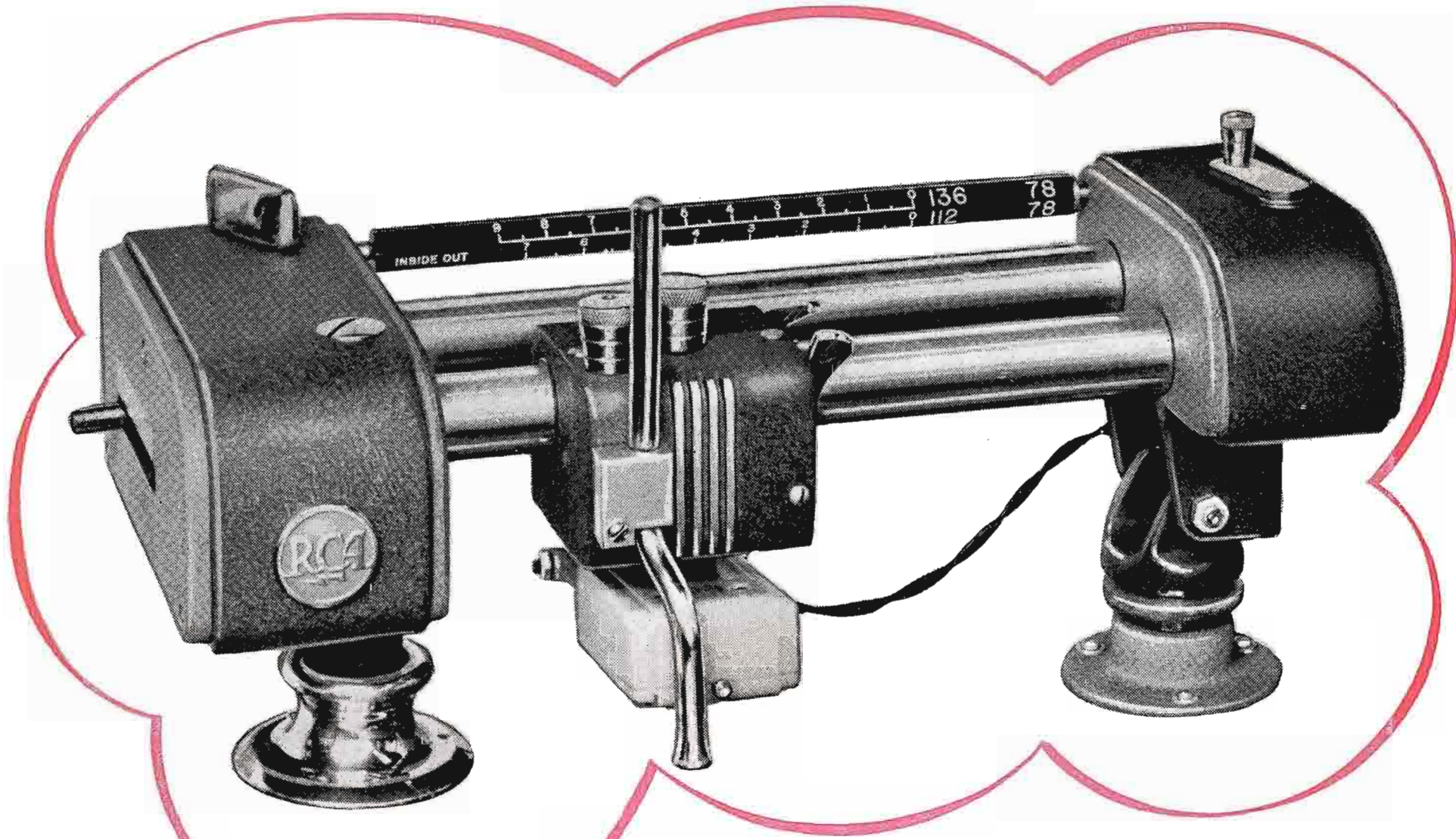

The RCA Recorder mounted on a Type 70-D1 turntable

## ... makes your RCA turntable a high-fidelity recorder *-inexpensively*

**T**HIS IS THE NEW improved-type studio cutter. It is designed specifically to give you instantaneous high-quality recordings with your present "70 Series" turntable—at surprisingly low equipment cost to you.

**It's uniquely flexible**—With this professional attachment you can record at 96, 112, or 136 lines per inch—and at speeds of  $33\frac{1}{3}$  or 78 rpm. You can record outside-in or inside-out—without changing gears or lead screw. You can adjust the stylus cutting angle and cutting depth during recording.

**It's simple to operate**—A new improved cam-operated lowering device helps you lower the cutter gently to the record . . . eliminates stylus damage and deep cuts caused by sudden dropping. A spiralling hand crank enables you to in-

sert space between recordings without breaking groove continuity. Plenty convenient, too, for making starting and finishing spirals.

**It's dependable**—No driver slippage or "knocks" . . . because power coupling is made to the center of your turntable through a vertical shaft spiral gear and a three-pin driving flange. No cutter carriage riding on the feedscrew . . . because the carriage is supported on a metal tube that encloses and protects the feedscrew. No groove grouping . . . because the head rides smoothly along a tubular enclosure that protects the feedscrew.

Here, we believe, is the finest cutter yet designed for high-quality studio recording . . . at modest cost. Type 72-D is complete with a standard head, mounting base, rest-post, and suction nozzle.

Type 72-DX is complete with high-fidelity recording head, mounting base, rest-post, suction nozzle, and compensator.

For prices and details, see your RCA Broadcast Sales Engineer, or write Dept. 7J, RCA Engineering Products, Camden, N. J.

### SPECIFICATIONS

Input Impedance to Cutter . . . 15 ohms, nominal

Frequency Response:

type 72-D . . . . .  $\pm 3$  db, 50 - 7,500 cps  
type 72-DX . . . . .  $\pm 2$  db, 50-10,000 cps

Sensitivity (groove velocity 6.3 cm/spc.  
0.00079"—peak to peak) at 1,000 cps:

type 72-D . . . . . +30 dbm (1.0 watt)  
type 72-DX . . . . . +30 dbm (1.0 watt)



**BROADCAST EQUIPMENT**  
**RADIO CORPORATION of AMERICA**  
**ENGINEERING PRODUCTS DEPARTMENT, CAMDEN, N.J.**

In Canada: RCA VICTOR Company Limited, Montreal



RCA VICTOR's new  $6\frac{7}{8}$ " vinyl records (in seven colors keyed to musical types) have a  $1\frac{1}{2}$ " center hole and a raised shoulder in the label area—features that adapt them for use with a new-type ultra-fast changer in which the record changing mechanism is built into the center spindle.